



# Micro800 Programmable Controllers General Instructions

Catalog Numbers 2080-L50E, 2080-L70E, 2080-LC10,  
2080-LC20, 2080-LC30, 2080-LC50, 2080-LC70

Rockwell Automation Publication 2080-RM001L-EN-E - November 2023  
Supersedes Publication 2080-RM001K-EN-E - March 2022



## Important User Information

Read this document and the documents listed in the additional resources section about installation, configuration, and operation of this equipment before you install, configure, operate, or maintain this product. Users are required to familiarize themselves with installation and wiring instructions in addition to requirements of all applicable codes, laws, and standards.

Activities including installation, adjustments, putting into service, use, assembly, disassembly, and maintenance are required to be carried out by suitably trained personnel in accordance with applicable code of practice.

If this equipment is used in a manner not specified by the manufacturer, the protection provided by the equipment may be impaired.

In no event will Rockwell Automation, Inc. be responsible or liable for indirect or consequential damages resulting from the use or application of this equipment.

The examples and diagrams in this manual are included solely for illustrative purposes. Because of the many variables and requirements associated with any particular installation, Rockwell Automation, Inc. cannot assume responsibility or liability for actual use based on the examples and diagrams.

No patent liability is assumed by Rockwell Automation, Inc. with respect to use of information, circuits, equipment, or software described in this manual.

Reproduction of the contents of this manual, in whole or in part, without written permission of Rockwell Automation, Inc., is prohibited.

Throughout this manual, when necessary, we use notes to make you aware of safety considerations.



**WARNING:** Identifies information about practices or circumstances that can cause an explosion in a hazardous environment, which may lead to personal injury or death, property damage, or economic loss.

---



**ATTENTION:** Identifies information about practices or circumstances that can lead to personal injury or death, property damage, or economic loss. Attentions help you identify a hazard, avoid a hazard, and recognize the consequence.

---

**IMPORTANT** Identifies information that is critical for successful application and understanding of the product.

---

Labels may also be on or inside the equipment to provide specific precautions.



**SHOCK HAZARD:** Labels may be on or inside the equipment, for example, a drive or motor, to alert people that dangerous voltage may be present.

---



**BURN HAZARD:** Labels may be on or inside the equipment, for example, a drive or motor, to alert people that surfaces may reach dangerous temperatures.

---



**ARC FLASH HAZARD:** Labels may be on or inside the equipment, for example, a motor control center, to alert people to potential Arc Flash. Arc Flash will cause severe injury or death. Wear proper Personal Protective Equipment (PPE). Follow ALL Regulatory requirements for safe work practices and for Personal Protective Equipment (PPE).

---

Rockwell Automation recognizes that some of the terms that are currently used in our industry and in this publication are not in alignment with the movement toward inclusive language in technology. We are proactively collaborating with industry peers to find alternatives to such terms and making changes to our products and content. Please excuse the use of such terms in our content while we implement these changes.

<b>Preface</b>	In this manual .....	15
	Supported controllers .....	15
	Additional resources .....	15
	Legal Notices.....	16
	<b>Chapter 1</b>	
<b>Find information about instructions and ladder elements</b>	Instruction blocks .....	19
	Operators .....	19
	Functions .....	19
	Function blocks .....	21
	Instruction set in alphabetical order .....	22
	<b>Chapter 2</b>	
<b>Ladder Diagram (LD) language</b>	Ladder Diagram (LD) program.....	29
	LD program development environment.....	29
	Instruction Toolbar (LD) .....	30
	Add instruction elements from instruction toolbar .....	30
	<b>Chapter 3</b>	
<b>Ladder Diagram (LD) elements</b>	Rung.....	33
	Add a rung to a LD program .....	33
	Rung labels .....	34
	Rung comments.....	35
	Branch.....	36
	Add a branch to a LD program.....	37
	Instruction Block (LD) .....	39
	Coil .....	39
	Add coil elements.....	40
	Direct Coil.....	41
	Reverse Coil.....	42
	Pulse Falling Edge Coil.....	43
	Pulse Rising Edge Coil.....	43
	Set Coil.....	44
	Reset Coil.....	45
	Contact.....	45
	Add a contact to a LD program .....	46
	Direct Contact .....	48
	Reverse Contact .....	48
	Pulse Rising Edge Contact .....	49
	Pulse Falling Edge Contact.....	50
	Return .....	50

	Jump .....	51
	Instruction blocks in LD programs .....	52
	Work in the LD language editor .....	53
	Ladder Diagram (LD) program examples .....	54
	LD Keyboard shortcuts .....	55
	 <b>Chapter 4</b>	
<b>Alarm instruction</b>	LIM_ALRM (limit alarm) .....	59
	 <b>Chapter 5</b>	
<b>Arithmetic instructions</b>	ABS (absolute value) .....	63
	ACOS (arccosine of source) .....	65
	ACOS_LREAL (arccosine Long Real) .....	66
	Addition .....	68
	ASIN (arcsine) .....	69
	ASIN_LREAL (arcsine Long Real) .....	71
	ATAN (arctangent) .....	72
	ATAN_LREAL (arctangent Long Real) .....	74
	COS (cosine) .....	75
	COS_LREAL (cosine Long Real) .....	77
	Division .....	78
	EXPT (exponent) .....	80
	LOG (log base 10) .....	82
	MOD (modulo) .....	83
	MOV (move) .....	85
	Multiplication .....	86
	Neg (negation) .....	88
	POW (raise power) .....	89
	RAND (random value) .....	91
	SIN (sine) .....	93
	SIN_LREAL (sine Long Real) .....	94
	SQRT (square root) .....	96
	Subtraction .....	97
	TAN (tangent) .....	99
	TAN_LREAL (tangent Long Real) .....	100
	TRUNC (truncate) .....	102
	 <b>Chapter 6</b>	
<b>ASCII serial port instructions</b>	ABL (ASCII test for buffer line) .....	105
	ACL (ASCII clear buffer) .....	107
	AHL (ASCII handshake lines) .....	109
	ACB (ASCII characters in buffer) .....	111

	ARD (ASCII read) .....	113
	ARL (ASCII read line) .....	115
	AWA (ASCII write append).....	117
	AWT (ASCII write) .....	119
	ASCII parameter details .....	121
	ABLACB data type .....	122
	ACL data type.....	122
	AHL ChannelSts data type.....	122
	AHLI data type.....	123
	ARDARL data type.....	123
	AWAAWT data type.....	123
	<b>Chapter 7</b>	
<b>Binary instructions</b>	AND_MASK (AND mask) .....	125
	BSL (bit shift left) .....	126
	BSR (bit shift right) .....	130
	NOT_MASK (bit to bit NOT mask) .....	133
	OR_MASK (bit to bit OR mask) .....	134
	ROL (rotate left) .....	136
	ROR (rotate right).....	137
	SHL (shift left) .....	139
	SHR (shift right) .....	141
	XOR_MASK (exclusive OR mask).....	143
	<b>Chapter 8</b>	
<b>Boolean instructions</b>	F_TRIG (falling edge detection).....	145
	R_TRIG (rising edge detector) .....	147
	RS (reset/set).....	148
	OR .....	149
	AND .....	150
	XOR (exclusive OR) .....	151
	NOT .....	151
	SR (set/reset).....	152
	TTABLE (truth table) .....	153
	MUX8B (multiplexer of 8 BOOL inputs) .....	156
	MUX4B (multiplexer of 4 BOOL inputs).....	160
	<b>Chapter 9</b>	
<b>Communication instructions</b>	COM_IO_WDOG .....	163
	MSG_CIPGENERIC (common industrial protocol generic message).....	165
	CIPAPPCFG data type.....	167
	CIPCONTROLCFG data type.....	168

CIPSTATUS data type .....	169
CIPSTATUS status bits .....	169
CIPSTATUS error codes .....	170
CIPTARGETCFG data type .....	171
Target path for CIP messaging .....	171
CIP/EIP message connections .....	172
CIP message timeout timers .....	173
MSG_CIPSYMBOLIC (common industrial protocol symbolic message)	
.....	173
CIPSYMBOLICCFG data type .....	175
Symbolic Read/Write syntax.....	176
Supported Data Packet Size for CIP Serial Function .....	176
MSG_MODBUS (modbus message).....	177
MODBUSLOCPARA data type.....	179
Message execution process (Rung = TRUE).....	181
MODBUSTARPARA data type .....	182
MSG_MODBUS2 (MODBUS/TCP message) .....	182
MODBUS2LOCPARA data type.....	186
MODBUS2TARPARA data type .....	187
MSG_PCCC (programmable controller communication commands	
message).....	188
CIPCONTROLCFG data type.....	190
PCCCCFG data type .....	191
TARGETCFG data type.....	192
CIPSTATUS data type .....	194
CIPSTATUS status bits .....	194
CIP/EIP message connections .....	195
Message timeout .....	196
MSG_PCCC error codes.....	196
Example: Create an MSG_PCCC messaging program to write a	
value to and read a value from an address in MicroLogix .....	198
PCCC Write example: Add an MSG_PCCC function block,	
variables, and a contact .....	199
PCCC Read example: Add a PCCC_MSG function block,	
variables, and a contact .....	202
Message execution processes and timing diagrams .....	205
Message execution process (general) .....	205
Message execution process (Rung = TRUE) .....	206
Message execution timing diagram (Rung = TRUE).....	207
Message execution process (Rung = FALSE).....	208
Message execution timing diagram (Rung = FALSE).....	209
Message execution process (Error).....	210

Message execution timing diagram (Error).....	211
Message execution timing diagram (PCCC configuration error)..	211
Message execution timing diagram (message is canceled) .....	212
Use the communication (message) function blocks.....	213
Configure object data values for explicit messaging (MSG_CIPGENERIC) .....	213
Example: How to create an MSG_CIPGENERIC messaging program to read data from a controller .....	215
Identify initial values for the input variables, MSG_CIPGENERIC.....	216
Add a MSG_CIPGENERIC function block and variables .....	216
Configure initial values for variables .....	217
Add a contact and a coil.....	220
Add a COP function block, variables and contact (MSG_CIPGENERIC) .....	221
Verify correct IP configuration on Controller B.....	222
Example: How to create an MSG_CIPSYMBOLIC messaging program to write a value to a variable .....	223
Add a COP function block, variables and a contact (MSG_CIPSYMBOLIC) .....	224
Add an Equal operator and a coil.....	225
Add a MSG_CIPSYMBOLIC function block, variables and a contact .....	226
Verify correct IP configuration on Controller B.....	228
Create global variable for Controller B.....	229
Review the complete program results.....	229
Example: How to configure Modbus communication to read from and write to a drive .....	231
Communication protocol support .....	235
Embedded communication channels.....	237

## Chapter 10

### Compare instructions

Equal .....	239
Greater than .....	242
Greater than or equal .....	244
Less than .....	245
Less than or equal.....	247
Not equal.....	247

## Chapter 11

### Counter instructions

CTD (count down).....	251
CTU (count up).....	253

	CTUD (count up down).....	255
	<b>Chapter 12</b>	
<b>Data conversion instructions</b>	ANY_TO_BOOL.....	259
	ANY_TO_BYTE.....	260
	ANY_TO_DATE.....	261
	ANY_TO_DINT.....	263
	ANY_TO_DWORD.....	264
	ANY_TO_INT.....	265
	ANY_TO_LINT.....	266
	ANY_TO_LREAL.....	267
	ANY_TO_LWORD.....	268
	ANY_TO_REAL.....	269
	ANY_TO_SINT.....	270
	ANY_TO_STRING.....	270
	ANY_TO_TIME.....	272
	ANY_TO_UDINT.....	273
	ANY_TO_UINT.....	274
	ANY_TO_ULINT.....	275
	ANY_TO_USINT.....	276
	ANY_TO_WORD.....	277
	<b>Chapter 13</b>	
<b>Data manipulation instructions</b>	AVERAGE.....	279
	COP.....	280
	Copy to a different data type.....	283
	COP string array example.....	284
	MIN (minimum).....	286
	MAX (maximum).....	287
	<b>Chapter 14</b>	
<b>High-Speed Counter (HSC) instructions</b>	What is a High-Speed Counter?.....	291
	HSC (high-speed counter).....	292
	HSCCmd values.....	293
	HSCAPP data type.....	294
	HSCSTS data type.....	297
	PLS data type.....	304
	HSCE_CHANNEL data type.....	305
	HSCE_STS data type.....	306
	PLS_HSCE data type.....	306
	HSC_SET_STS (high-speed counter set status).....	307
	Use the High-Speed Counter instructions.....	309



Update HSC application data.....	309
High-Speed Counter (HSC) User Interrupt dialog box .....	310
Configure a High-Speed Counter (HSC) User Interrupt.....	310
Add and configure a High-Speed Counter (HSC) User Interrupt...	311
HSC Interrupt properties.....	311
HSC Interrupt parameters.....	312
Configure a Programmable Limit Switch (PLS) .....	314
Example: How to create a High-Speed Counter (HSC) program...	315
Create a ladder diagram and add variables .....	316
Assign values to the HSC variables.....	319
Assign variables and build the program .....	320
Test the program and run the High-Speed Counter.....	321
Add a Programmable Limit Switch (PLS) function .....	323
Example: Programmable Limit Switch (PLS) enabled.....	325

## Chapter 15

### HSCE instructions

HSCE.....	327
HSCE_CFG .....	330
HSCE_CFG_PLS .....	332
HSCE_READ_STS .....	335
HSCE_SET_STS.....	336
HSCE error codes .....	339

## Chapter 16

### Input/Output instructions

LCD .....	341
LCD_BKLT_REM (remote LCD backlight).....	344
LCD_REM (remote LCD) .....	346
RHC (read high speed clock) .....	348
RPC (read program checksum) .....	350
DLG (data log).....	351
IIM (immediate input).....	353
IOM (immediate output) .....	354
KEY_READ (read keys on LCD).....	356
KEY_READ_REM (read keys for remote LCD).....	359
MM_INFO (memory module information).....	361
MMINFO data type .....	363
MODULE_INFO .....	364
MODULE_INFO - plug-in and expansion module information ....	368
MODULE_INFO instruction timing diagrams.....	370
PLUGIN_INFO (plug-in information).....	375
PLUGIN_READ (read plugin).....	377
PLUGIN_RESET (reset plugin) .....	379

PLUGIN_WRITE (write plugin) .....	381
RCP (recipe) .....	383
RTC_READ ( read real-time clock) .....	385
RTC_SET (set real-time clock) .....	387
SYS_INFO .....	389
SYS_INFO data type.....	391
TRIMPOT_READ (read trimpot) .....	392
Trimpot ID definition .....	393

### Chapter 17

#### Interrupt instructions

STIS (select timed start) .....	395
UIC (clear interrupt lost bit) .....	397
UID (disable interrupt) .....	398
UIE (enable interrupt).....	400
UIF (flush pending interrupt) .....	402

### Chapter 18

#### Motion control instructions

General rules for motion control function blocks .....	405
Motion control function block parameter details .....	408
Motion control axis states .....	408
Motion control function block parameter numbers .....	410
Motion control function block error IDs.....	411
Axis error scenarios.....	413
AXIS_REF data type.....	413
FB_AXIS_REF data type .....	414
Axis variables .....	414
MC_AbortTrigger (motion control abort trigger).....	415
MC_Halt (motion control halt).....	418
MC_Home (motion control home) .....	421
MC_MoveAbsolute (motion control move absolute) .....	424
MC_MoveRelative (motion control move relative) .....	428
MC_MoveVelocity (motion control move velocity) .....	432
MC_Power (motion control power) .....	436
MC_ReadActualPosition (motion control read actual position) .....	440
MC_ReadActualVelocity (motion control read actual velocity) .....	444
MC_ReadAxisError (motion control read axis error).....	447
AxisErrorID error codes .....	450
MC_ReadBoolParameter (motion control read BOOL parameter) .....	451
MC_ReadParameter (motion control read parameter).....	454
MC_ReadStatus (motion control read status) .....	456
MC_Reset (motion control reset) .....	461
MC_SetPosition (motion control set position) .....	463

	MC_Stop (motion control stop) .....	466
	MC_TouchProbe (motion control touch probe).....	470
	MC_WriteBoolParameter (motion control write BOOL parameter) ...	473
	MC_WriteParameter (motion control write parameter) .....	475
	<b>Chapter 19</b>	
<b>Process control instructions</b>	DERIVATE .....	479
	FFL (FIFO load) .....	481
	FFL and FFU instruction timing diagrams .....	485
	FFU (FIFO unload).....	489
	HYSTER (hysteresis) .....	494
	INTEGRAL .....	496
	AND .....	500
	LFL(LIFO load).....	501
	LFU(LIFO unload).....	503
	PWM (Pulse Width Modulation).....	505
	SCALER (scale) .....	508
	STACKINT (stack integers).....	510
	SCL.....	513
	SCL instruction timing diagrams examples .....	516
	TND (stop current program) .....	520
	LIMIT (limit test) .....	521
	<b>Chapter 20</b>	
<b>Program control instruction</b>	AFI (Always False) .....	525
	NOP (No Operation) .....	525
	SUS (suspend).....	525
	<b>Chapter 21</b>	
<b>Proportional Integral Derivative (PID) instruction</b>	What is Proportional Integral Derivative (PID) control? .....	529
	IPIDCONTROLLER (proportional-integral-derivative controller).....	529
	GAIN_PID data type .....	533
	AT_Param data type .....	534
	How the IPIDController function block implements PID control.	534
	IPIDController function block operation.....	535
	Use the Proportional Integral Derivative instruction .....	536
	Use auto-tune with the IPIDController function block .....	539
	Auto-tune in first and second order systems .....	539
	Configure auto-tuning .....	540
	Use a Selectable Timed Interrupt (STI) with auto-tuning .....	544
	Example: IPIDController with auto-tune .....	544

Example: How to create a feedback loop for the manipulated value .....546

Example: How to add a UDFB to a PID program .....547

Example: How to create an IPIDController program to control temperature.....547

Example: How to create an IPIDController program to control water supply level.....549

PID (proportional-integral-derivative)..... 551

PID instruction state machine .....556

PID instruction timing diagrams .....556

**Real Time Clock (RTC) instructions**

**Chapter 22**

RTC\_READ ( read real-time clock) .....561

RTC\_SET (set real-time clock) ..... 563

**Socket instructions**

**Chapter 23**

SOCKET\_ACCEPT ..... 568

SOCKET\_CREATE .....571

SOCKET\_DELETE .....576

SOCKET\_DELETEALL .....578

SOCKET\_INFO ..... 580

SOCKET\_OPEN .....586

SOCKET\_READ ..... 590

SOCKET\_WRITE .....594

SOCKADDR\_CFG data type .....598

SOCK\_STATUS data type.....598

Socket error codes .....599

Socket instruction status bits ..... 602

Socket instruction timing diagrams ..... 603

Socket instruction transaction diagrams ..... 609

Transactions for TCP Client ..... 609

Transactions for TCP Server.....610

Transactions for UDP with Open Connection .....610

Transactions for UDP without Open Connections ..... 611

State machine diagrams for TCP ..... 611

State machine diagrams for UDP ..... 614

**String manipulation instructions**

**Chapter 24**

ASCII .....617

CHAR (ASCII code to string character)..... 619

DELETE (delete sub-string) .....620

FIND (find sub-string) ..... 622

INSERT (insert string) ..... 624  
 LEFT (extract left of a sting) ..... 626  
 MID (extract middle of a string) ..... 628  
 MLEN (string length) ..... 630  
 RIGHT (extract right of a string) ..... 631  
 REPLACE (replace sub-string) ..... 633

**Chapter 25**

**Timer instructions**

Timer instruction configuration ..... 637  
 TOF (timer, off-delay) ..... 637  
 TON (timer, on-delay) ..... 639  
 TONOFF (time-delay, on, off) ..... 641  
 TP (pulse timing) ..... 644  
 RTO (retentive timer, on-delay) ..... 646  
 DOY (check year for real-time clock) ..... 648  
 TDF (time difference) ..... 650  
 TOW (check week for real-time clock) ..... 652

**Index**



## In this manual

This guide provides reference information about the instruction set available for developing programs for use in Micro800™ control systems. The instruction set includes Structured Text (ST), Ladder Diagram (LD) Function Block Diagram (FBD) programming language support. Additionally, the ladder elements supported in Connected Components Workbench™ development environment are defined.

## Supported controllers

Connected Components Workbench includes configuration support for the following Micro800 controllers.

- 2080-LC10-12AWA
- 2080-LC10-12DWD
- 2080-LC10-12QBB
- 2080-LC10-12QWB
- 2080-LC20-20AWB
- 2080-LC20-20QBB
- 2080-LC20-20QWB
- 2080-LC30-10QVB
- 2080-LC30-10QWB
- 2080-LC30-16AWB
- 2080-LC30-16QVB
- 2080-LC30-16QWB
- 2080-LC30-24QBB
- 2080-LC30-24QVB
- 2080-LC30-24QWB
- 2080-LC30-48AWB
- 2080-LC30-48QBB
- 2080-LC30-48QVB
- 2080-LC30-48QWB
- 2080-LC50-24AWB
- 2080-LC50-24QBB
- 2080-LC50-24QVB
- 2080-LC50-24QWB
- 2080-LC50-48AWB
- 2080-LC50-48QBB
- 2080-LC50-48QVB
- 2080-LC50-48QWB
- 2080-LC50-48QWB - SIM
- 2080-L50E-24AWB
- 2080-L50E-24QBB
- 2080-L50E-24QVB
- 2080-L50E-24QWB
- 2080-L50E-48AWB
- 2080-L50E-48QBB
- 2080-L50E-48QVB
- 2080-L50E-48QWB
- 2080-L70E-24AWB
- 2080-L70E-24QBB
- 2080-L70E-24QBBN
- 2080-L70E-24QWB
- 2080-L70E-24QWBN
- 2080-LC70-24AWB
- 2080-LC70-24QBB
- 2080-LC70-24QWB

## Additional resources

These documents contain additional information concerning related Rockwell Automation® products.

Resource	Description
----------	-------------

Resource	Description
Industrial Automation Wiring and Grounding Guidelines, publication 1770-4.1 available at <a href="http://literature.rockwellautomation.com/idc/groups/literature/documents/in/1770-in041_-en-p.pdf">http://literature.rockwellautomation.com/idc/groups/literature/documents/in/1770-in041_-en-p.pdf</a> .	Provides general guidelines for installing a Rockwell Automation industrial system.
Product Certifications website, <a href="http://www.ab.com">http://www.ab.com</a>	Provides declarations of conformity, certificates, and other certification details.
MicroLogix Controllers to Micro800 Controllers Migration Guide, available at <a href="https://literature.rockwellautomation.com/idc/groups/literature/documents/rm/2080-rm002_-en-e.pdf">https://literature.rockwellautomation.com/idc/groups/literature/documents/rm/2080-rm002_-en-e.pdf</a>	Shows how to use the software tools to select a suitable Micro800 controller, and also how to convert your MicroLogix programs to work with the Micro800 controller.
Micro800 Controllers Starter Pack Quick Start, available at <a href="https://literature.rockwellautomation.com/idc/groups/literature/documents/qs/2080-qs004_-en-e.pdf">https://literature.rockwellautomation.com/idc/groups/literature/documents/qs/2080-qs004_-en-e.pdf</a>	Shows how to use a Micro800 controller with a PanelView 800 terminal.
Configuring Micro800 Controllers on FactoryTalk Gateway, available at <a href="https://literature.rockwellautomation.com/idc/groups/literature/documents/qs/2080-qs005_-en-e.pdf">https://literature.rockwellautomation.com/idc/groups/literature/documents/qs/2080-qs005_-en-e.pdf</a>	Provides quick start instructions for configuring a Micro800 controller on FactoryTalk Linx Gateway.

You can view or download publications at <http://www.rockwellautomation.com/literature>. To order paper copies of technical documentation, contact your local Rockwell Automation distributor or sales representative.

## Legal Notices

Rockwell Automation publishes legal notices, such as privacy policies, license agreements, trademark disclosures, and other terms and conditions on the [Legal Notices](#) page of the Rockwell Automation website.

## Software and Cloud Services Agreement

Review and accept the Rockwell Automation Software and Cloud Services Agreement [here](#).

## Open Source Software Licenses

The software included in this product contains copyrighted software that is licensed under one or more open source licenses.

You can view a full list of all open source software used in this product and their corresponding licenses by opening the `oss_license.txt` file located in your product's `OPENSOURCE` folder on your hard drive. This file is divided into these sections:

- Components  
Includes the name of the open source component, its version number, and the type of license.



- **Copyright Text**  
Includes the name of the open source component, its version number, and the copyright declaration.
- **Licenses**  
Includes the name of the license, the list of open source components citing the license, and the terms of the license.

The default location of this file is:

C:\Program Files (x86)\Common Files\Rockwell\Help\*<product name>*\Release Notes\OPENSOURCE\oss\_licenses.txt.

You may obtain Corresponding Source code for open source packages included in this product from their respective project web site(s).

Alternatively, you may obtain complete Corresponding Source code by contacting Rockwell Automation via the **Contact** form on the Rockwell Automation website:

<http://www.rockwellautomation.com/global/about-us/contact/contact.page>.

Please include "Open Source" as part of the request text.

## Commercial Software Licenses

The following table lists the commercially licensed software components in Connected Components Workbench.

Component	Copyright
Actipro v17.1.0851	Copyright (c) 2002-2013 Actipro Software LLC
ag-grid v21.0.1	Copyright (c) 2015-2020 AG GRID LTD



## Find information about instructions and ladder elements

Connected Components Workbench includes a comprehensive instruction set with structures and arrays, development environments for ladder logic, structured text, function block diagram, and user-defined function block programs.

Additionally, Connected Components Workbench includes user-interface configuration tools for Micro800 controllers, PowerFlex® drives, a Safety Relay device, PanelView™ Component graphic terminals, and serial and network connectivity options.

For information about a specific instruction, including a description, parameter details, and language examples, locate the instruction from the table of contents, or from the following reference topics.

- [Instruction reference in alphabetical order](#) on [page 22](#)

For a description of the ladder elements used in Connected Components Workbench, see the following section:

- [Ladder Diagram \(LD\) language reference](#) on [page 29](#)

### Instruction blocks

The Connected Components Workbench instruction set includes IEC 61131-3 compliant instruction blocks for Micro800 controllers. Instruction blocks collectively include [operators](#) on [page 19](#), [functions](#) on [page 19](#) and [function blocks](#) on [page 21](#).

### Operators

The Connected Components Workbench instruction set includes IEC 61131-3 compliant instruction blocks for Micro800 controllers; operators are included in the Connected Components Workbench instruction set.

An operator is a basic logical operation such as arithmetic, boolean, comparator, or data conversion.

### Functions

Functions have one or more input parameters and one output parameter.

### Instruction block format

An instruction block is represented by a single rectangle, and has a fixed number of input connection points and output connection points. An elementary instruction block performs a single function.

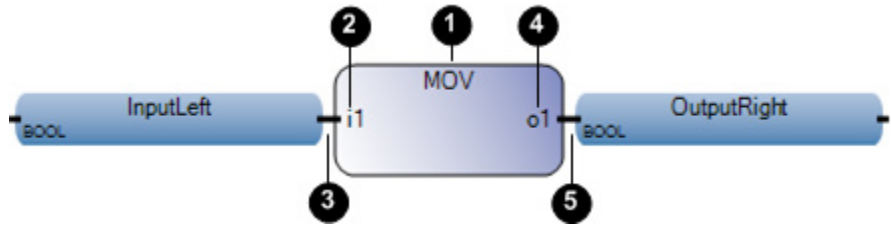

Item No.	Item	Description
1	Block name	The name of the function to be performed by the instruction block is written inside its rectangle shape (at the top).
2	Input	Each input of an instruction block is labeled and has a defined type.
3	Input connection	Inputs are connected on the left border.
4	Output	Each output of an instruction block is labeled and has a defined type.
5	Output connection	Outputs are connected on the right border.

### Calling a function

Connected Components Workbench does not support recursive function calls. When a function of the Functions section is called by itself or one of its called functions, a run-time error occurs. Furthermore, functions do not store the local values of their local variables. Since functions are not instantiated, they cannot call function blocks.

- A function can be called by a program, by a function, or by a function block.
- Any program of any section can call one or more functions. A function can have local variables.
- A function has no instance meaning local data is not stored and so is usually lost from one call to the other.
- Because the execution of a function is driven by its parent program, the execution of the parent program is suspended until the function ends.

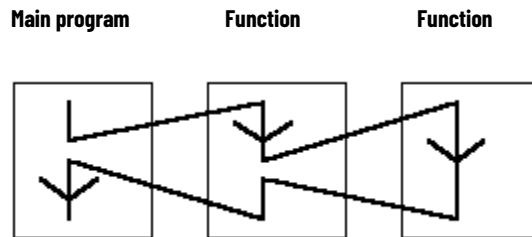

## Defining function and parameter names

The interface of a function must be explicitly defined with a type and a unique name for each of its calling (input) parameters or return (output) parameters. A function has one return parameter. The value of a return parameter for a function block is different for each programming language (FBD, LD, ST).

Function names and function parameter names can use up to 128 characters. Function parameter names can begin with a letter or an underscore followed by letters, numbers, and single underscores.

## Function blocks

A function block is an instruction block that has input and output parameters and works on internal data (parameters). It can be written in Structured Text, Ladder Diagram, or Function Block Diagram languages.

### Instruction block format

An instruction block is represented by a single rectangle, and has a fixed number of input connection points and output connection points. An elementary instruction block performs a single function.

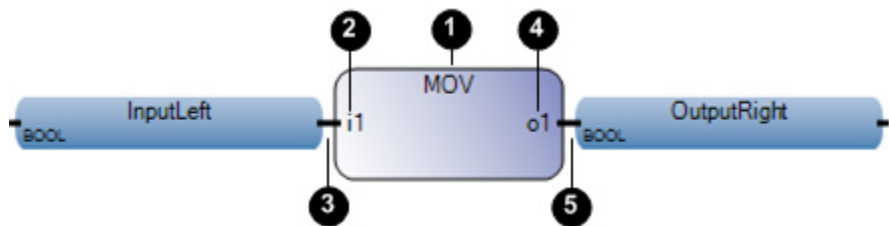

Item No.	Item	Description
1	Block name	The name of the function to be performed by the instruction block is written inside its rectangle shape (at the top).
2	Input	Each input of an instruction block is labeled and has a defined type.
3	Input connection	Inputs are connected on the left border.
4	Output	Each output of an instruction block is labeled and has a defined type.
5	Output connection	Outputs are connected on the right border.

### Calling a function block

When a function block is called in a program, an instance of the block is actually called. The instance uses the same code, but the input and output parameters are instantiated, which means local variables are copied for each instance of the function block. The values of the variables of a function block instance are stored from one cycle to the other.

A function block can be called by a program, or by another function block. They cannot be called by functions because functions are not instantiated.

## Defining function block and parameter names

The interface of a function block must be explicitly defined with a type and a unique name for each of its calling (input) parameters or return (output) parameters. Function blocks can have more than one output parameter. The value of a return parameter for a function block is different for each programming language (FBD, LD, ST).

Function block names and function block parameter names can use up to 128 characters. Function block parameter names can begin with a letter or an underscore followed by letters, numbers, and single underscores.

The following table lists the Micro800 controller instructions available in Connected Components Workbench and their mapped instructions in Logix theme in alphabetical order.

## Instruction set in alphabetical order

Instruction	Mapped Instruction (Logix Theme)	Category	Type	Description
<a href="#">-</a> on <a href="#">page 97</a>	SUB	Arithmetic	Operator	Subtracts one Integer, Real or Time value from another Integer, Real or Time value.
<a href="#">*</a> on <a href="#">page 86</a>	MUL	Arithmetic	Operator	Multiplies two or more Integer or Real values.
<a href="#">/</a> on <a href="#">page 78</a>	DIV	Arithmetic	Operator	Division of two Integer or Real values.
<a href="#">+</a> on <a href="#">page 68</a>	ADD	Arithmetic	Operator	Adds two or more Integer, Real, Time, or String values.
<a href="#">&lt;</a> on <a href="#">page 245</a>	LES	Compare	Operator	Compares Integer, Real, Time, Date, and String input values to determine whether the first is less than the second.
<a href="#">&lt;=</a> on <a href="#">page 247</a>	LEQ	Compare	Operator	Compares Integer, Real, Time, Date, and String input values to determine whether the first is less than or equal to the second.
<a href="#">&lt;&gt;</a> on <a href="#">page 247</a>	NEQ	Compare	Operator	Compares Integer, Real, Time, Date, and String input values to determine whether the first is not equal to the second.
<a href="#">=</a> on <a href="#">page 239</a>	EQU	Compare	Operator	Tests whether one value is equal to another.
<a href="#">&gt;</a> on <a href="#">page 242</a>	GRT	Compare	Operator	Compares Integer, Real, Time, Date, and String input values to determine whether the first is greater than the second.
<a href="#">&gt;=</a> on <a href="#">page 244</a>	GEQ	Compare	Operator	Compares Integer, Real, Time, Date, and String input values to determine whether the first is greater than or equal to the second.
<a href="#">ABL</a> on <a href="#">page 105</a>	ABL	Communications	Function block	Counts the number of characters in the buffer up to and including end of line character.
<a href="#">ABS</a> on <a href="#">page 63</a>	ABS	Arithmetic	Function	Returns the absolute value of a Real value.
<a href="#">ACB</a> on <a href="#">page 111</a>	ACB	Communications	Function block	Counts the total number of characters in the buffer.
<a href="#">ACL</a> on <a href="#">page 107</a>	ACL	Communications	Function block	Clears the receive and transmit buffers.
<a href="#">ACOS</a> on <a href="#">page 65</a>	ACS	Arithmetic	Function	Calculates the arc-cosine of a Real value.
<a href="#">ACOS_LREAL</a> on <a href="#">page 66</a>	ACOS_LREAL	Arithmetic	Function	Calculates the arc-cosine of a Long Real value.
<a href="#">AFI</a> on <a href="#">page 525</a>	AFI	Program control	Function	Temporarily disables a rung when debugging.
<a href="#">AHL</a> on <a href="#">page 109</a>	AHL	Communications	Function block	Sets or resets modem handshake lines.
<a href="#">AND</a> on <a href="#">page 150</a>	AND	Boolean operations	Operator	Performs a boolean AND operation between two or more values.
<a href="#">AND_MASK</a> on <a href="#">page 125</a>	AND_MASK	Binary operations	Function	Performs a bit to bit AND between two Integer values.
<a href="#">ANY_TO_BOOL</a> on <a href="#">page 259</a>	ANY_TO_BOOL	Data conversion	Function	Converts a non-Boolean value to a Boolean.
<a href="#">ANY_TO_BYTE</a> on <a href="#">page 260</a>	ANY_TO_BYTE	Data conversion	Function	Converts a value to a Byte.

Instruction	Mapped Instruction (Logix Theme)	Category	Type	Description
<a href="#">ANY_TO_DATE</a> on <a href="#">page 261</a>	ANY_TO_DATE	Data conversion	Function	Converts a String, Integer, Real, or Time data type to Date data type.
<a href="#">ANY_TO_DINT</a> on <a href="#">page 263</a>	STOD	Data conversion	Function	Converts a value to a Double Integer.
<a href="#">ANY_TO_DWORD</a> on <a href="#">page 264</a>	ANY_TO_DWORD	Data conversion	Function	Converts a value to a Double Word value.
<a href="#">ANY_TO_INT</a> on <a href="#">page 265</a>	ACI	Data conversion	Function	Converts a value to an Integer.
<a href="#">ANY_TO_LINT</a> on <a href="#">page 266</a>	ANY_TO_LINT	Data conversion	Function	Converts a value to a Long Integer.
<a href="#">ANY_TO_LREAL</a> on <a href="#">page 267</a>	ANY_TO_LREAL	Data conversion	Function	Converts a value to a Long Real.
<a href="#">ANY_TO_LWORD</a> on <a href="#">page 268</a>	ANY_TO_LWORD	Data conversion	Function	Converts a value to a Long Word.
<a href="#">ANY_TO_REAL</a> on <a href="#">page 269</a>	STOR	Data conversion	Function	Converts a value to a Real.
<a href="#">ANY_TO_SINT</a> on <a href="#">page 270</a>	ANY_TO_SINT	Data conversion	Function	Converts a value to a Short Integer.
<a href="#">ANY_TO_STRING</a> on <a href="#">page 270</a>	DTOS	Data conversion	Function	Converts a value to a String.
<a href="#">ANY_TO_TIME</a> on <a href="#">page 272</a>	ANY_TO_TIME	Data conversion	Function	Converts a value to the Time data type.
<a href="#">ANY_TO_UDINT</a> on <a href="#">page 273</a>	ANY_TO_UDINT	Data conversion	Function	Converts a value to an Unsigned Double Integer.
<a href="#">ANY_TO_UINT</a> on <a href="#">page 274</a>	ANY_TO_UINT	Data conversion	Function	Converts a value to an Unsigned Integer.
<a href="#">ANY_TO_ULINT</a> on <a href="#">page 275</a>	ANY_TO_ULINT	Data conversion	Function	Converts a value to an Unsigned Long Integer.
<a href="#">ANY_TO_USINT</a> on <a href="#">page 276</a>	ANY_TO_USINT	Data conversion	Function	Converts a value to an Unsigned Short Integer.
<a href="#">ANY_TO_WORD</a> on <a href="#">page 277</a>	ANY_TO_WORD	Data conversion	Function	Converts a value to a Word.
<a href="#">ARD</a> on <a href="#">page 113</a>	ARD	Communications	Function block	Reads characters from the input buffer and places them into a string.
<a href="#">ARL</a> on <a href="#">page 115</a>	ARL	Communications	Function block	Reads one line of characters from the input buffer and places them into a string.
<a href="#">ASCII</a> on <a href="#">page 617</a>	ASCII	String manipulation	Function	Returns the ASCII code for characters in a string. Character -> ASCII code.
<a href="#">ASIN</a> on <a href="#">page 69</a>	ASN	Arithmetic	Function	Calculates the arcsine of a Real value.
<a href="#">ASIN_LREAL</a> on <a href="#">page 71</a>	ASN_LREAL	Arithmetic	Function	Calculates the arcsine of a Long Real value.
<a href="#">ATAN</a> on <a href="#">page 72</a>	ATN	Arithmetic	Function	Calculates the arctangent of a Real value.
<a href="#">ATAN_LREAL</a> on <a href="#">page 74</a>	ATAN_LREAL	Arithmetic	Function	Calculates the arctangent of a Long Real value.
<a href="#">AVERAGE</a> on <a href="#">page 279</a>	AVE	Data Manipulation	Function block	Calculates a running average over a number of a defined samples.
<a href="#">AWA</a> on <a href="#">page 117</a>	AWA	Communications	Function	Writes a string with two appended (user-configured) characters to an external device.
<a href="#">AWT</a> on <a href="#">page 119</a>	AWT	Communications	Function	Writes characters from a source string to an external device.
<a href="#">BSL</a> on <a href="#">page 126</a>	BSL	Binary operations	Function block	Shifts a bit in an array element to the left.
<a href="#">BSR</a> on <a href="#">page 130</a>	BSR	Binary operations	Function block	Shifts a bit in an array element to the right.
<a href="#">CHAR</a> on <a href="#">page 619</a>	CHAR	String manipulation	Function	Returns a one character string for an ASCII code. ASCII code -> character.
<a href="#">COM_IO_WDOG</a> on <a href="#">page 163</a>	COM_IO_WDOG	Communications	Function block	Monitors communication to the controller.
<a href="#">COP</a> on <a href="#">page 280</a>	COP	Data conversion	Function block	Copies the binary data in the source element to the destination element.
<a href="#">COS</a> on <a href="#">page 75</a>	COS	Arithmetic	Function	Calculates the cosine of a Real value.
<a href="#">COS_LREAL</a> on <a href="#">page 77</a>	COS_LREAL		Function	Calculates the cosine of a Long Real value.
<a href="#">CTD</a> on <a href="#">page 251</a>	CTD	Counter	Function	Counts integers from a given value down to 0, 1 by 1.
<a href="#">CTU</a> on <a href="#">page 253</a>	CTU	Counter	Function	Counts integers from 0 up to a given value, 1 by 1.
<a href="#">CTUD</a> on <a href="#">page 255</a>	CTUD	Counter	Function	Counts integers from 0 up to a given value, 1 by 1, or from a given value down to 0, 1 by 1.
<a href="#">DELETE</a> on <a href="#">page 620</a>	DELETE	String manipulation	Function	Deletes characters from a string.
<a href="#">DERIVATE</a> on <a href="#">page 479</a>	DERIVATE	Process Control	Function block	Differentiation of a real value over a defined cycle time.

Instruction	Mapped Instruction (Logix Theme)	Category	Type	Description
<a href="#">DLG on page 351</a>	DLG	Input/Output	Function Block	Writes variable values from the run-time engine into a Data Logging File on an SD Card.
<a href="#">DOY on page 648</a>	DOY	Time	Function	Turn on an output if the value of the real-time clock is in the range of the Year Time setting.
<a href="#">EXPT on page 80</a>	EXPT	Arithmetic	Function	Calculates the Real value of a base number raised to the power of the Integer exponent.
<a href="#">F_TRIG on page 145</a>	OSF	Boolean operations	Function block	Detects a falling edge of a Boolean variable.
<a href="#">FFL on page 489</a>	FFL	Process Control	Function Block	Loads 8 bit, 16 bit, 32 bit, or 64 bit data into a user-created array called a FIFO stack.
<a href="#">FFU on page 489</a>	FFU	Process Control	Function Block	Unloads 8 bit, 16 bit, 32 bit, or 64 bit data from a user-created array called a FIFO (first in first out) stack in the same order data was loaded using the FFL instruction.
<a href="#">FIND on page 622</a>	FIND	String manipulation	Function	Locates and provides the position of sub-strings within strings.
<a href="#">HSC on page 292</a>	HSC	Input/Output	Function block	HSC applies high presets, low presets and output source values to the high-speed counter.
<a href="#">HSC_SET_STS on page 307</a>	HSC_SET_STS	Input/Output	Function block	HSC_SET_STS manually sets or resets the HSC counting status.
<a href="#">HSCE on page 327</a>	HSCE	Input/Output	Function block	HSCE start, stop and read accumulator value.
<a href="#">HSCE_CFG on page 330</a>	HSCE_CFG	Input/Output	Function block	HSCE_CFG is the high speed counter configuration.
<a href="#">HSCE_CFG_PLS on page 332</a>	HSCE_CFG_PLS	Input/Output	Function block	HSCE_CFG_PLS is the high speed counter PLS configuration.
<a href="#">HSCE_READ_STS on page 335</a>	HSCE_READ_STS	Input/Output	Function block	HSCE_READ_STS reads high speed counter status.
<a href="#">HSCE_SET_STS on page 336</a>	HSCE_SET_STS	Input/Output	Function block	HSCE_SET_STS manually set/reset high speed counter status.
<a href="#">HYSTER on page 494</a>	HYSTER	Process Control	Function block	Boolean hysteresis on difference of reals.
<a href="#">IIM on page 353</a>	IIM	Input/Output	Function block	Updates inputs prior to normal output scan.
<a href="#">INSERT on page 624</a>	INSERT	String manipulation	Function	Inserts sub-strings at user-defined positions within strings.
<a href="#">INTEGRAL on page 496</a>	INTEGRAL	Process Control	Function block	Integrates a real value during the defined cycle time.
<a href="#">IOM on page 354</a>	IOM	Input/Output	Function block	Updates outputs prior to normal output scan.
<a href="#">IPIDCONTROLLER on page 529</a>	IPIDCONTROLLER	Process Control	Function block	Configure and control the inputs and outputs used for the Proportional Integral Derivative (PID) logic.
<a href="#">KEY_READ on page 356</a>		Input/Output	Function block	Micro810 only. Reads the Key status on the optional LCD module when the user display is active.
<a href="#">KEY_READ_REM on page 359</a>	KEY_READ_REM	Input/Output	Function block	Micro820 only. Reads the Key status on the optional Remote LCD module when the user display is active.
<a href="#">LCD on page 341</a>		Input/Output	Function	Micro810 only. Displays a string or number on an LCD screen.
<a href="#">LCD_BKLT_REM on page 344</a>	LCD_BKLT_REM	Input/Output	Function	Sets the Remote LCD backlight parameters in a user program.
<a href="#">LCD_REM on page 346</a>	LCD_REM	Input/Output	Function	Displays user defined messages for the Remote LCD.
<a href="#">LEFT on page 626</a>	LEFT	String manipulation	Function	Extracts characters from the left side of a string.
<a href="#">LFL(LIFO load) on page 501</a>	LFL	Process Control	Function block	Loads 8 bit, 16 bit, 32 bit, or 64 bit data into a user-created array called a LIFO stack.
<a href="#">LFU(LIFO unload) on page 503</a>	LFU	Process Control	Function block	Unloads 8 bit, 16 bit, 32 bit, or 64 bit data from a user-created array called a LIFO (last in first out) stack in the same order data was loaded using the LFL instruction.
<a href="#">LIM_ALARM on page 59</a>	LIM	Alarm	Function block	An alarm with hysteresis on a Real value for high and low limits.
<a href="#">LIMIT on page 521</a>	LIMIT	Process Control	Function	Restricts integer values to a given interval.
<a href="#">LOG on page 82</a>	LOG	Arithmetic	Function	Calculates the logarithm (base 10) of a Real value.
<a href="#">MAX on page 287</a>	MAX	Data Manipulation	Function	Calculates the maximum of two integer values.



Instruction	Mapped Instruction (Logix Theme)	Category	Type	Description
<a href="#">MC_AbortTrigger</a> on <a href="#">page 415</a>	MC_AbortTrigger	Motion	Function block	Aborts Motion function blocks that are connected to trigger events.
<a href="#">MC_Halt</a> on <a href="#">page 418</a>	MC_Halt	Motion	Function block	Commands a controlled motion stop under normal operating conditions.
<a href="#">MC_Home</a> on <a href="#">page 421</a>	MAH	Motion	Function block	Commands the axis to perform the <i>&lt;search home&gt;</i> sequence.
<a href="#">MC_MoveAbsolute</a> on <a href="#">page 424</a>	MAM	Motion	Function block	Commands a controlled motion to a specified absolute position.
<a href="#">MC_MoveRelative</a> on <a href="#">page 428</a>	MC_MoveRelative	Motion	Function block	Commands a controlled motion of a specified distance relative to the actual position at the time of the execution.
<a href="#">MC_MoveVelocity</a> on <a href="#">page 432</a>	MCD	Motion	Function block	Commands a never ending controlled motion at a specified velocity.
<a href="#">MC_Power</a> on <a href="#">page 436</a>	MSO	Motion	Function block	Control the power stage, ON or OFF.
<a href="#">MC_ReadActualPosition</a> on <a href="#">page 444</a>	MC_ReadActualPosition	Motion	Function block	Returns the actual position of the feedback axis.
<a href="#">MC_ReadActualVelocity</a> on <a href="#">page 444</a>	MC_ReadActualVelocity	Motion	Function block	Returns the actual velocity of the feedback axis.
<a href="#">MC_ReadAxisError</a> on <a href="#">page 447</a>	MC_ReadAxisError	Motion	Function block	Reads the axis errors not related to the Motion control instruction blocks.
<a href="#">MC_ReadBoolParameter</a> on <a href="#">page 451</a>	MC_ReadBoolParameter	Motion	Function block	Returns the value of a vendor specific parameter of type BOOL.
<a href="#">MC_ReadParameter</a> on <a href="#">page 454</a>	MC_ReadParameter	Motion	Function block	Returns the value of a vendor specific parameter of type Real.
<a href="#">MC_ReadStatus</a> on <a href="#">page 456</a>	MC_ReadStatus	Motion	Function block	Returns the status of the axis with respect to the motion currently in progress.
<a href="#">MC_Reset</a> on <a href="#">page 461</a>	MAFR	Motion	Function block	Transitions the axis state from ErrorStop to StandStill by resetting all internal axis-related errors.
<a href="#">MC_SetPosition</a> on <a href="#">page 463</a>	MRP	Motion	Function block	Shifts the coordinate system of an axis by manipulating the actual position.
<a href="#">MC_Stop</a> on <a href="#">page 466</a>	MAS	Motion	Function block	Commands a controlled motion stop and transfers the axis state to Stopping.
<a href="#">MC_TouchProbe</a> on <a href="#">page 470</a>	MC_TouchProbe	Motion	Function block	Records an axis position at a trigger event.
<a href="#">MC_WriteBoolParameter</a> on <a href="#">page 473</a>	MC_WriteBoolParameter	Motion	Function block	Modifies the value of a vendor specific parameter of type Bool.
<a href="#">MC_WriteParameter</a> on <a href="#">page 475</a>	MC_WriteParameter	Motion	Function block	Modifies the value of a vendor specific parameter of type Real.
<a href="#">MID</a> on <a href="#">page 628</a>	MID	String manipulation	Function	Extracts characters from the middle of a string.
<a href="#">MIN</a> on <a href="#">page 286</a>	MIN	Data Manipulation	Function	Calculates the minimum of two integer values.
<a href="#">MLEN</a> on <a href="#">page 630</a>	MLEN	String manipulation	Function	Calculates the length of a string.
<a href="#">MM_INFO</a> on <a href="#">page 361</a>	MM_INFO	Input/Output	Function block	Reads memory module header information.
<a href="#">MOD</a> on <a href="#">page 83</a>	MOD	Arithmetic	Function	Performs a Modulo calculation on Integer values.
<a href="#">MODULE_INFO</a> on <a href="#">page 364</a>	MODULE_INFO	Input/Output	Function block	Reads module information from a plug-in module or an expansion module.
<a href="#">MOV</a> on <a href="#">page 85</a>	MOV	Arithmetic	Operator	Assigns the input value to the output.
<a href="#">MSG_CIPGENERIC</a> on <a href="#">page 165</a>	MSG	Communications	Function	Sends a CIP generic explicit message.
<a href="#">MSG_CIPSYMBOLIC</a> on <a href="#">page 173</a>	MSG_CIPSYMBOLIC	Communications	Function	Sends a CIP symbolic explicit message.
<a href="#">MSG_MODBUS</a> on <a href="#">page 177</a>	MSG_MODBUS	Communications	Function	Sends a Modbus message.
<a href="#">MSG_MODBUS2</a> on <a href="#">page 182</a>	MSG_MODBUS2	Communications	Function	Sends a MODBUS/TCP message over an Ethernet Channel.
<a href="#">MSG_PCCC</a> on <a href="#">page 188</a>	MSG_PCCC	Communications	Function	Sends a PCCC message over an Ethernet channel or a serial port.
<a href="#">MUX4B</a> on <a href="#">page 160</a>	MUX4B	Boolean	Function	Multiplexer between four BOOL inputs, outputs a BOOL value.
<a href="#">MUX8B</a> on <a href="#">page 156</a>	MUX8B	Boolean	Function	Multiplexer between eight BOOL inputs, outputs a BOOL value.
<a href="#">Neg</a> on <a href="#">page 88</a>	NEG	Arithmetic	Operator	Converts a value to a negative.

## Chapter 1 Find information about instructions and ladder elements

Instruction	Mapped Instruction (Logix Theme)	Category	Type	Description
<a href="#">NOP on page 525</a>	NOP	Program Control	Function	Functions as a placeholder.
<a href="#">NOT on page 151</a>	NOT	Boolean operations	Operator	Converts Boolean values to negated values.
<a href="#">NOT_MASK on page 133</a>	NOT_MASK	Binary operations	Function	Integer bit-to-bit negation mask, inverts a parameter value.
<a href="#">OR on page 149</a>	OR	Boolean operations	Operator	Boolean OR of two or more values.
<a href="#">OR_MASK on page 134</a>	OR_MASK	Binary operations	Function	Integer OR bit-to-bit mask, turns bits on.
<a href="#">PID on page 551</a>	PID	Process Control	Function block	An output instruction that controls physical properties such as temperature, pressure, liquid level, or flow rate using process loops.
<a href="#">PLUGIN_INFO on page 375</a>	PLUGIN_INFO	Input/Output	Function block	Gets module information from a generic plug-in module (excluding Memory Module).
<a href="#">PLUGIN_READ on page 377</a>	PLUGIN_READ	Input/Output	Function block	Reads data from a generic plug-in module (excluding Memory Module).
<a href="#">PLUGIN_RESET on page 379</a>	PLUGIN_RESET	Input/Output	Function block	Resets a generic plug-in module, hardware reset (excluding Memory Module).
<a href="#">PLUGIN_WRITE on page 381</a>	PLUGIN_WRITE	Input/Output	Function block	Writes data to a generic plug-in module (excluding Memory Module).
<a href="#">POW on page 89</a>	XPY	Arithmetic	Function	Calculates the value of a Real number raised to a power of the Real exponent.
<a href="#">PWM on page 505</a>	PWM	Process Control	Function block	Turns the PWM (Pulse Width Modulation) output for a configured PWM channel ON or OFF.
<a href="#">R_TRIG on page 147</a>	OSR	Boolean operations	Function block	Detects a rising edge of a Boolean variable.
<a href="#">RAND on page 91</a>	RAND	Arithmetic	Function	Calculates random integer values from a defined range.
<a href="#">RCP on page 383</a>	RCP	Input/Output	Function block	Reads and writes recipe data to and from an SD memory card.
<a href="#">REPLACE on page 633</a>	REPLACE	String manipulation	Function	Replaces parts of a string with new sets of characters.
<a href="#">RHC on page 348</a>	RHC	Input/Output	Function	Reads high-speed clock.
<a href="#">RIGHT on page 631</a>	RIGHT	String manipulation	Function	Extracts characters from the right side of a string.
<a href="#">ROL on page 136</a>	ROL	Binary operations	Function	For 32-bit integers, rotates integer bits to the left.
<a href="#">ROR on page 137</a>	ROR	Binary operations	Function	For 32-bit integers, rotates integer bits to the right.
<a href="#">RPC on page 350</a>	RPC	Input/Output	Function	Reads user program checksum.
<a href="#">RS on page 148</a>	RS	Boolean operations	Function block	Reset dominant bistable.
<a href="#">RTC_READ on page 385</a>	RTC_READ	Input/Output	Function block	Reads the real-time clock (RTC) module information.
<a href="#">RTC_SET on page 387</a>	RTC_SET	Input/Output	Function block	Sets RTC (real-time clock) data to the RTC module information.
<a href="#">RTO on page 646</a>	RTO	Time	Function block	Retentive timing. Increases an internal timer when input is active, but does not reset the internal timer when input changes to inactive.
<a href="#">SCALER on page 508</a>	SCP	Process Control	Function block	Scales the input value according to output range.
<a href="#">SCL on page 513</a>	SCL	Process Control	Function block	Converts an unscaled input value to a floating point value in engineering units.
<a href="#">SHL on page 139</a>	SHL	Binary operations	Function	For 32-bit integers, moves integers to the left and places 0 in the least significant bit.
<a href="#">SHR on page 141</a>	SHR	Binary operations	Function	For 32-bit integers, moves integers to the right and places 0 in the most significant bit.
<a href="#">SIN on page 93</a>	SIN	Arithmetic	Function	Calculates the sine of a Real value.
<a href="#">SIN_LREAL on page 94</a>	SIN_LREAL	Arithmetic	Function	Calculates the sine of a Long Real value.
<a href="#">SOCKET_ACCEPT on page 568</a>	SOCKET_ACCEPT	Communications	Function block	Accepts a TCP connection request from a remote destination and returns a socket instance used to send and receive data on the newly created connection.

Instruction	Mapped Instruction (Logix Theme)	Category	Type	Description
<a href="#">SOCKET_CREATE</a> on <a href="#">page 571</a>	SOCKET_CREATE	Communications	Function block	Creates an instance of the socket and returns an instance number that is used as an input in any follow-on socket operations.
<a href="#">SOCKET_DELETE</a> on <a href="#">page 576</a>	SOCKET_DELETE	Communications	Function block	Deletes a created socket instance.
<a href="#">SOCKET_DELETEALL</a> on <a href="#">page 578</a>	SOCKET_DELETEALL	Communications	Function block	Deletes all created socket instances.
<a href="#">SOCKET_INFO</a> on <a href="#">page 580</a>	SOCKET_INFO	Communications	Function block	Returns information for the socket such as error codes and execution status.
<a href="#">SOCKET_OPEN</a> on <a href="#">page 586</a>	SOCKET_OPEN	Communications	Function block	Opens the connection for the specified destination address for Transmission Control Protocol (TCP) connections. For User Datagram Protocol (UDP) connections, associates a destination IP address and port number with the specified socket.
<a href="#">SOCKET_READ</a> on <a href="#">page 590</a>	SOCKET_READ	Communications	Function block	Reads data on a socket.
<a href="#">SOCKET_WRITE</a> on <a href="#">page 594</a>	SOCKET_WRITE	Communications	Function block	Sends data on a socket.
<a href="#">SORT</a> on <a href="#">page 96</a>	SQR	Arithmetic	Function	Calculates the square root of a Real value.
<a href="#">SR</a> on <a href="#">page 152</a>	SR	Boolean operations	Function block	Set dominant bistable.
<a href="#">STACKINT</a> on <a href="#">page 510</a>	STACKINT	Process Control	Function block	Manages stack of integers.
<a href="#">STIS</a> on <a href="#">page 395</a>	STS	Interrupt	Function	Starts the selected timed user interrupt (STI ) timer from the control program rather than starting automatically.
<a href="#">SUS</a> on <a href="#">page 525</a>	SUS	Program Control	Function block	Suspends the execution of the <M800 controller>.
<a href="#">SYS_INFO</a> on <a href="#">page 389</a>	SYS_INFO	Input/Output	Function block	Reads the status data block for the Micro800 controller.
<a href="#">TAN</a> on <a href="#">page 99</a>	TAN	Arithmetic	Function	Calculates the tangent of a Real value.
<a href="#">TAN_LREAL</a> on <a href="#">page 100</a>	TAN_LREAL	Arithmetic	Function	Calculates the tangent of a Long Real value.
<a href="#">TDF</a> on <a href="#">page 650</a>	TDF	Time	Function	Computes the time difference between TimeA and TimeB.
<a href="#">TND</a> on <a href="#">page 520</a>	TND	Process Control	Function	Stops the current cycle of the user program scan.
<a href="#">TOF</a> on <a href="#">page 637</a>	TOF	Time	Function block	Off-delay timing. Increases an internal timer up to a given value.
<a href="#">TON</a> on <a href="#">page 639</a>	TON	Time	Function block	On-delay timing. Increases an internal timer up to a given value.
<a href="#">TONOFF</a> on <a href="#">page 641</a>	TONOFF	Time	Function block	Delay turning on an output on a true rung, and then delay turning off the output on the false rung.
<a href="#">TOW</a> on <a href="#">page 652</a>	TOW	Time	Function	Turns on an output if the value of the real-time clock is in the range of the Time of Week setting.
<a href="#">TP</a> on <a href="#">page 644</a>	TP	Time	Function block	Pulse timing. On a rising edge, increases an internal timer up to a given value.
<a href="#">TRIMPOT_READ</a> on <a href="#">page 392</a>	TRIMPOT_READ	Input/Output	Function block	Reads the trimpot value from a specific trimpot.
<a href="#">TRUNC</a> on <a href="#">page 102</a>	TRN	Arithmetic	Function	Truncates Real values, leaving just the Integer.
<a href="#">TTABLE</a> on <a href="#">page 153</a>	TTABLE	Boolean	Function	Provides the value of the output based on the combination of inputs.
<a href="#">UIC</a> on <a href="#">page 397</a>	UIC	Interrupt	Function	Clears the lost bit for the selected user interrupt.
<a href="#">UID</a> on <a href="#">page 398</a>	UID	Interrupt	Function	Disables a specific user interrupt.
<a href="#">UIE</a> on <a href="#">page 400</a>	UIE	Interrupt	Function	Enables a specific user input.
<a href="#">UIF</a> on <a href="#">page 402</a>	UIF	Interrupt	Function	Flushes or removes a pending user input.
<a href="#">XOR</a> on <a href="#">page 151</a>	XOR	Boolean operations	Operator	Boolean exclusive OR of two values.
<a href="#">XOR_MASK</a> on <a href="#">page 143</a>	XOR_MASK	Binary operations	Function	Integer exclusive OR bit-to-bit mask, returns inverted bit values.



## Ladder Diagram (LD) language

A Ladder Diagram (LD) is a graphical representation of Boolean equations that combines contacts (input arguments) with coils (output results). Using graphic symbols in a program chart (organized like a relay ladder wiring diagram), the LD language describes the tests and modifications of Boolean data.

LD graphic symbols are organized within the chart as an electrical contact diagram. The term "ladder" comes from the concept of rungs connected to vertical power rails at both ends where each rung represents an individual circuit.

Connected Components Workbench provides an LD language editor and supports the [elements](#) on [page 33](#) and instructions that are supplied with the Connected Components Workbench software only.

### Ladder Diagram (LD) program

A Ladder Diagram (LD) is a graphical representation of Boolean equations that combines contacts (input arguments) with coils (output results). Using graphic symbols in a program chart (organized like a relay ladder wiring diagram), the LD language describes the tests and modifications of Boolean data.

The LD language uses graphic symbols in a program chart, organized like a relay ladder wiring diagram, to describe the tests and modifications of Boolean data.

Connected Components Workbench provides an [Ladder Diagram language editor](#) on [page 53](#) that supports the elements and instructions that are supplied with the Connected Components Workbench software only.

### LD program development environment

The language editor for a Ladder Diagram (LD) program where you develop an LD Program Organizational Unit (POU).

The following picture shows the main areas of LD program development environment.

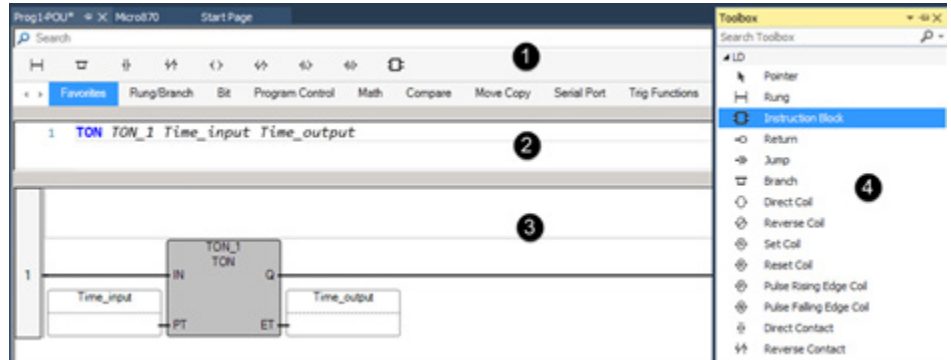

No.	Name	Description
1	<a href="#">Instruction toolbar on page 30</a>	Quickly select an instruction element and place it in the LD graphical editor, or single click to add in the LD text editor.
2	LD text editor	Edits the logic using ASCII instruction mnemonics.
3	LD graphic editor	Edits the logic using graphical instruction elements.
4	LD toolbox	Adds elements to the LD graphical editor.

## Instruction Toolbar (LD)

Instruction Toolbar is the colloquial name for the secondary pane in the language editor pane, which functions like a toolbar and is used to [add language elements on page 30](#) such as instructions to the language editor workspace. It is complementary to the general workbench toolbox.

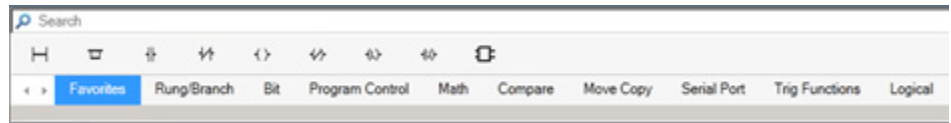

Item	Description
Tabs	Lists the instruction elements by category. Click on a category to see the instructions within that category. Arrow keys can also be used to select different categories. Click on the arrows to the left of the tabs to scroll through the categories. Click on the down arrow to the right of the tabs to see a list of all the categories.
Instructions	Lists the instructions that correspond to the Tabs category selected. A category may also have basic instruction elements pinned at the beginning of the list. Click on the arrows to the left of the instructions to scroll through the instructions.
Search	Filters the instructions by category immediately as names or description keyword is entered. Click on the category name to see the filtered instructions for that category.
Favorites	Customizes a list of instructions that can be quickly found and added to your program.

## Add instruction elements from instruction toolbar

Use the [Instruction toolbar on page 30](#) to search, navigate, and add instructions to Ladder Diagram (LD) program's language editor workspace.

## To add an instruction element from Instruction Toolbar to the language editor

1. Click on the category tab, which includes the instruction you want to add. You can navigate the tab using the Arrow Keys and reorder their position by a drag-and-drop operation.
2. Select the instruction by a drag-and-drop operation or clicking on it.
3. (optional) To quickly locate the instruction, click in the search field and then you can type to find the instruction element by name or keyword. To exit search and enable arrow key navigation, press the **Esc** key.
4. (optional) Right-click on the instruction and select **Add to Favorites** to add it to **Favorites** tab and select **Remove from Favorites** to remove it. The favorites setting will be automatically saved.





## Ladder Diagram (LD) elements

Ladder Diagram (LD) elements are the components used to build a ladder diagram program. All the elements listed in the following table can be added to a ladder diagram program within Connected Components Workbench.

Element	Description
<a href="#">Rung</a> on <a href="#">page 33</a>	Represents a group of circuit elements that lead to the activation of a coil.
<a href="#">Instruction Block (LD)</a> on <a href="#">page 39</a>	Instructions include operators, functions, and function blocks including user-defined function blocks.
<a href="#">Branch</a> on <a href="#">page 36</a>	Two or more instructions in parallel.
<a href="#">Coil</a> on <a href="#">page 39</a>	Represents the assignment of outputs or internal variables. In an LD program, a coil represents an action.
<a href="#">Contact</a> on <a href="#">page 45</a>	Represents the value or function of an input or internal variable.
<a href="#">Return</a> on <a href="#">page 50</a>	Represents the conditional end of a diagram output.
<a href="#">Jump</a> on <a href="#">page 51</a>	Represents the conditional and unconditional logic in the LD program that control the control the execution of diagrams.

### Rung

Rungs are graphic components of Ladder Diagram (LD) programs that represent a group of circuit elements that lead to the activation of a coil. Use labels to identify rungs within the diagram. Labels, along with jumps, control the execution of a diagram. Comments are free-format text you can add above the rung for documentation purposes.

### Add a rung to a LD program

[Rungs](#) on [page 33](#) are graphic components of a Ladder Diagram (LD) program that represent a group of circuit elements that lead to the activation of a coil.

In Connected Components Workbench, you can add a rung to a Ladder Diagram (LD) program from the:

- Language Diagram (LD) language editor
- Multi-language Editor located on the Tools menu
- LD Toolbox

### To add a rung element to a Ladder Diagram program

1. In the LD language editor, right-click an existing rung and then either:
  - Click **Copy**, and then click **Paste** to insert a copy of the rung into the language editor.
  - Click **Insert Rung**, and then either:
    - Click **Above** to add the rung above the selected rung.

- Click **Below** to add the rung below the selected rung.

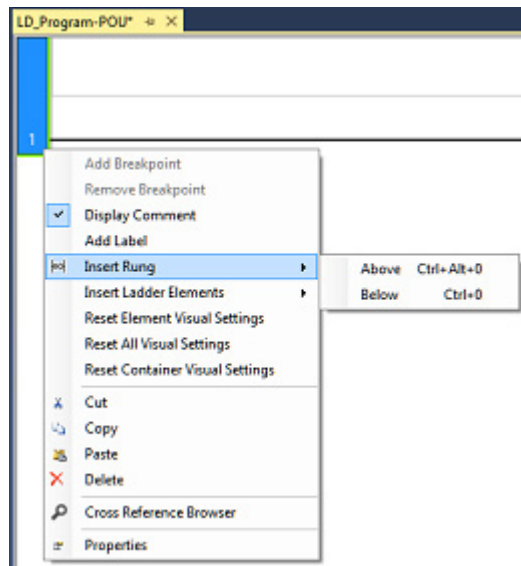

- Select a rung or an element in the LD language editor, and then press either:
  - **CTRL+ALT+O** - to add the rung above the selected rung.
  - **CTRL+O** - to add the rung below the selected rung.
- Select a rung or an element in the LD language editor, and then press either:
  - Click **Tools > Multi-language Editor > Insert Rung Below** to add the rung below the selected rung.
  - Click **Tools > Multi-language Editor > Insert Rung Above** to add the rung above the selected rung.

1. (optional) Open the LD Toolbox to show the rung element,
  - To insert a rung below an existing rung, select the rung in the LD language editor and then double-click **Rung** in the LD Toolbox.

If an element is not selected prior to double-clicking **Rung** in the LD Toolbox, the rung is inserted below the last rung in the LD language editor.

- Select **Rung** and then drag the element into the LD language editor.

A plus sign (+) appears in the LD language editor to show a valid target. Release the mouse button to add the element.



Tip: If the ladder diagram contains more than 355 rungs, use the down triangle rather than the scroll bar to view additional rungs.



## Rung labels

Labels are optional additions for every rung in the Ladder Diagram (LD) language editor.

Labels can be an unlimited number of characters, beginning with a letter or underscore character followed by letters, numbers, and underscore characters. Labels cannot have spaces or special characters (for example, '+', '-', or '\').

### To add a label for a rung in the LD language editor

1. To add a label to a rung, right-click the rung to open the LD language editor menu, and then select **Display Label**.

The rung updates to include the label and the LD language editor menu shows a checkmark next to **Display Label**.

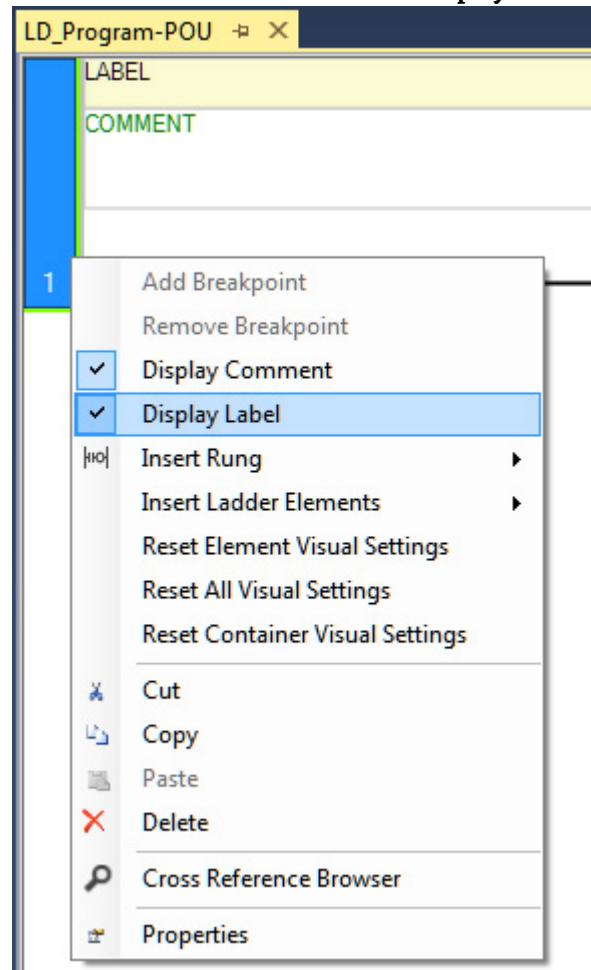

2. Select the **Label**, and type a description.
3. (optional) To remove the label, click **Display Label** from the LD language editor menu.

### Rung comments

Comments are optional for every rung in the Ladder Diagram (LD) language editor. By default, a comment is included when you [add a rung element in the LD language editor](#) on [page 33](#).

Comments are:

- Entered in the space above the rung.
- Saved in rich text format.

- Stored in the controller.

### To add or remove a comment for a rung in the LD language editor

1. To remove a comment, right-click the rung to open the LD language editor menu.

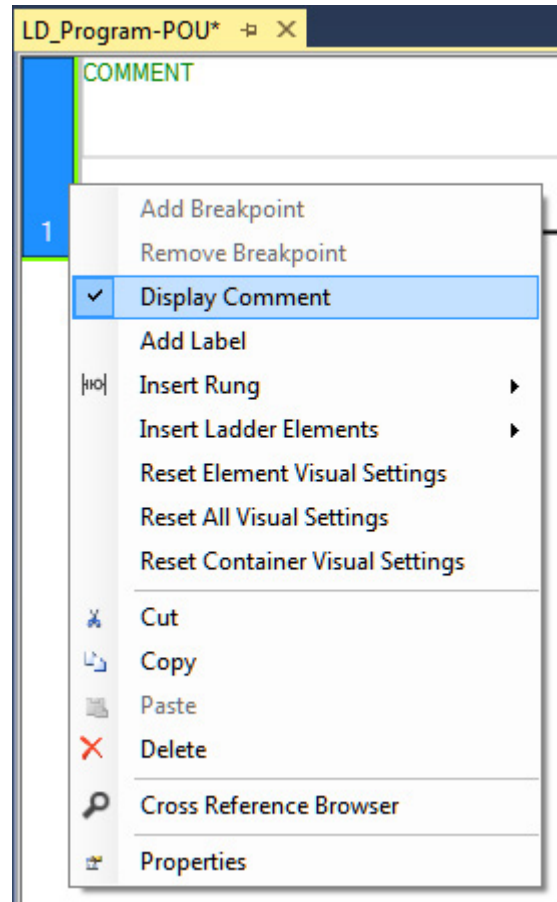

2. From the LD language editor menu, click **Display Comment**. The comment is removed from the rung and the check mark next to **Display Comment** on the LD language editor menu is removed.
3. (optional) To add a comment to a rung, click **Display Comment** from the LD language editor menu.

## Branch

Branches create alternative routing for connections. [You can add parallel branches to elements on a rung using the Ladder Diagram \(LD\) language editor on page 37.](#)

### Branch example

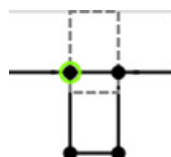

## Add a branch to a LD program

[Branches](#) on [page 36](#) are graphic components of Ladder Diagram (LD) programs that create alternative routing for connections and may include parallel branches.

In Connected Components Workbench, you can add a branch to a Ladder Diagram (LD) program from the:

- Ladder Diagram (LD) language editor
- Multi-language Editor located on the Tools menu
- LD Toolbox
- Instruction Toolbar (LD)

### To add a branch to a Ladder Diagram program

1. In the LD language editor, verify the LD program has a defined rung for the branch. Then do one of the following:
  - Right-click a rung or an element in the LD language editor, select **Insert Ladder Elements** and then click **Branch**.

If the **Variable Selector** opens, select a variable, or click **OK** without selecting a variable to add the **Branch** element.

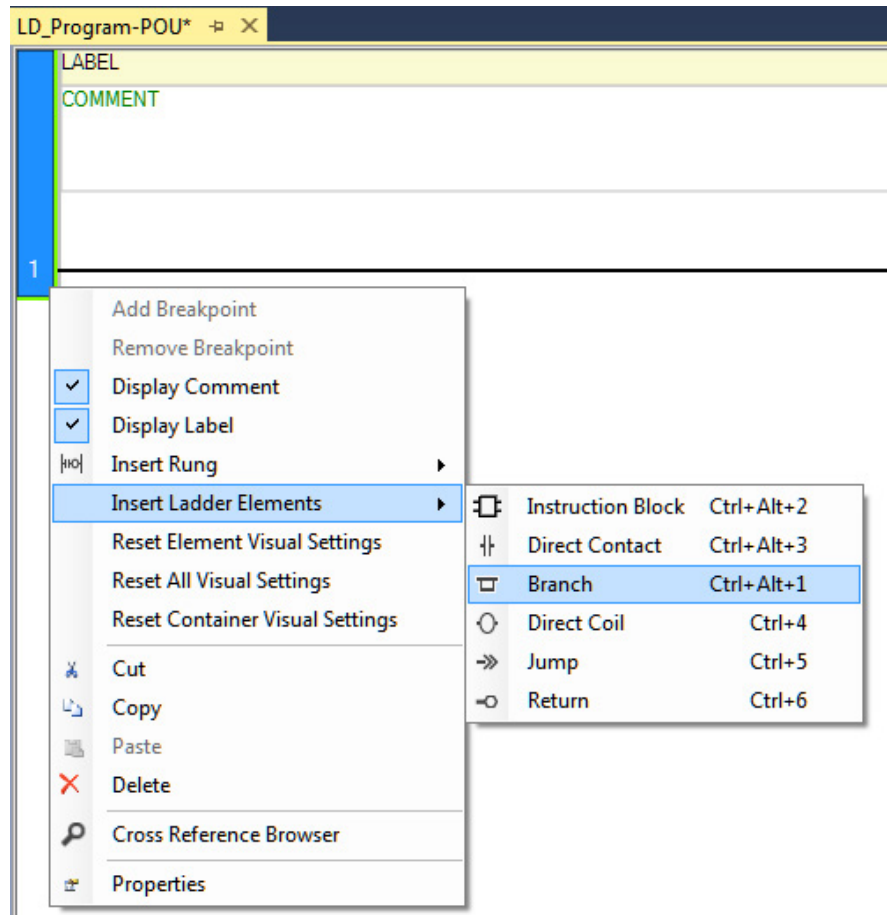

- Select a rung or element in the LD language editor and then press either:

**CTRL+ALT+I** to add the branch to the left of the selected element or rung.

**CTRL+I** to add the branch to the right of the selected element.

- Select a rung or an element in the LD language editor and then either:
  - Click **Tools > Multi-language Editor > Insert Branch Before** to add the branch to the left of the selected element.
  - Click **Tools > Multi-language Editor > Insert Branch After** to add the branch to the right of the selected element.
- Open the LD Toolbox to show the branch element and then either:
  - Double-click the branch element to add it to the LD language editor.
  - Drag the branch element into the LD language editor and position it on the rung.
  - A plus sign (+) appears in the LD language editor to show a valid target. Release the mouse button to add the element.
- 1. (optional) To insert a parallel branch:
  - a. In the LD language editor, right-click the branch to open the LD language editor menu.

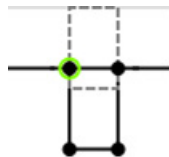

- b. From the LD language editor menu, select **Insert Branch** and then click either:

**Above** to add a branch above the selected branch.

**Below** to add the branch below the selected branch.

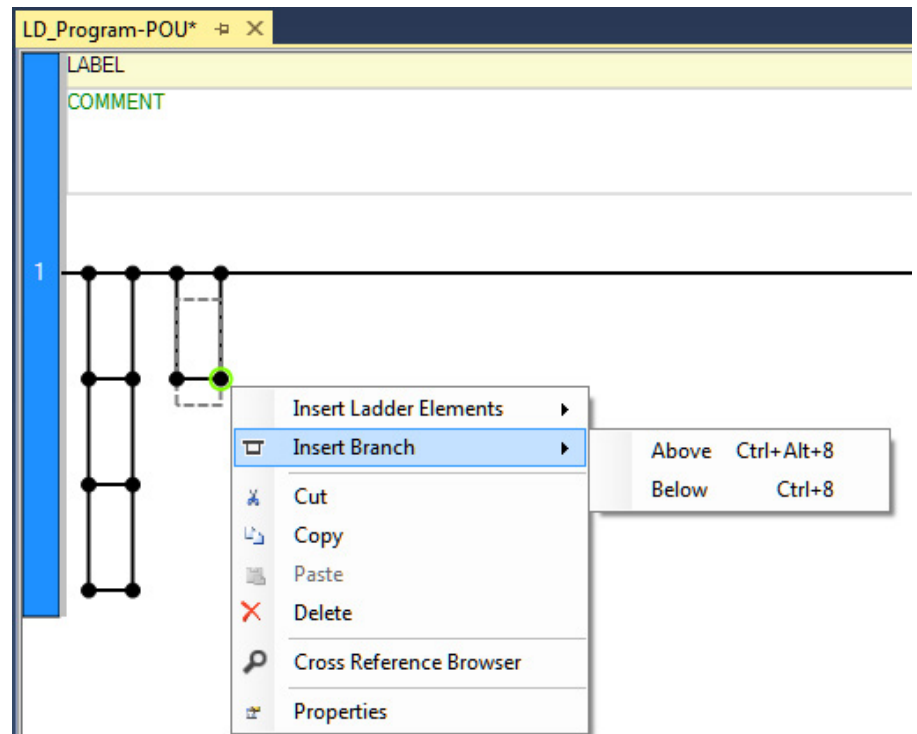

- (optional) To move a branch element to another location in a LD program, select the element and drag the element to new a location in the LD program.

A plus sign (+) appears in the LD language editor to show a valid target. Release the mouse button to insert the element in the target location.

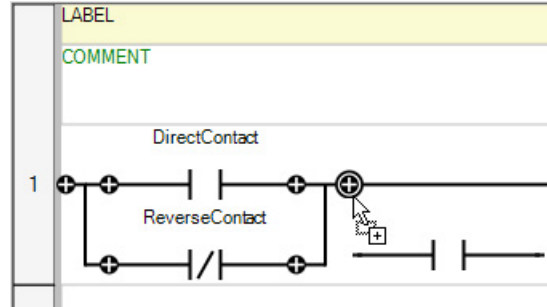

## Instruction Block (LD)

A Ladder Diagram (LD) Instruction Block element is a IEC 61131-3 compliant functional element in a LD program that can be a function block, a function, a user-defined function block, a user-defined function, or an operator.

## Coil

Coils are graphic components of Ladder Diagram (LD) programs that represent the assignment of an output or of an internal variable. In LD programs, a coil represents an action. A coil must be connected on the left to a Boolean symbol, such as a contact, or to a Boolean output of an instruction block. Coils can only be added to a defined rung in the LD language editor. The coil definition can be modified after the coil is added to the rung.

The following example shows the coil element types available for Ladder Diagram programs.

### Example: Coils

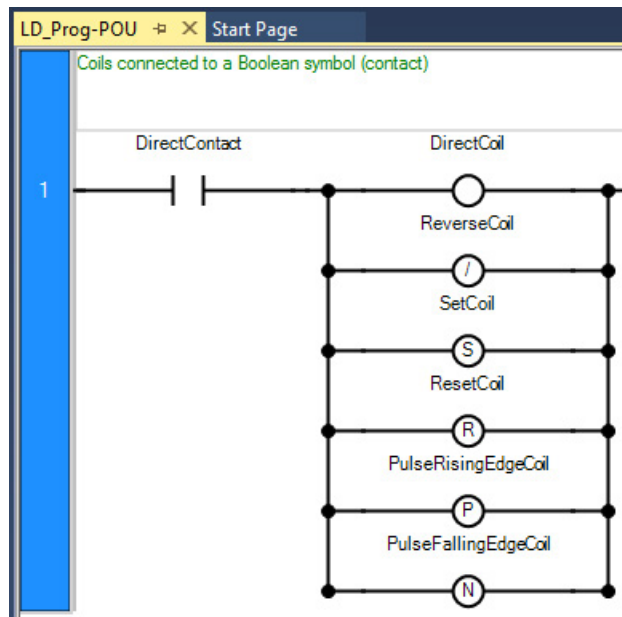

## Add coil elements

Coils are graphic components of Ladder Diagram (LD) programs that represent an action taken on an output or of an internal variable.

In Connected Components Workbench, you can add a coil to a Ladder Diagram (LD) program from the:

- Ladder Diagram (LD) language editor
- Multi-language Editor located on the Tools menu
- LD Toolbox
- Instruction Toolbar (LD)

1. To add a coil element to a Ladder Diagram program: in the LD language editor, verify the LD program has a defined rung for the coil. Then do one of the following:

- Right-click a rung or an element in the LD language editor, select **Insert Ladder Elements** and then click **Direct Coil**.

If the **Variable Selector** opens, select a variable, or click **OK** without selecting a variable to add the **Direct Coil** element.

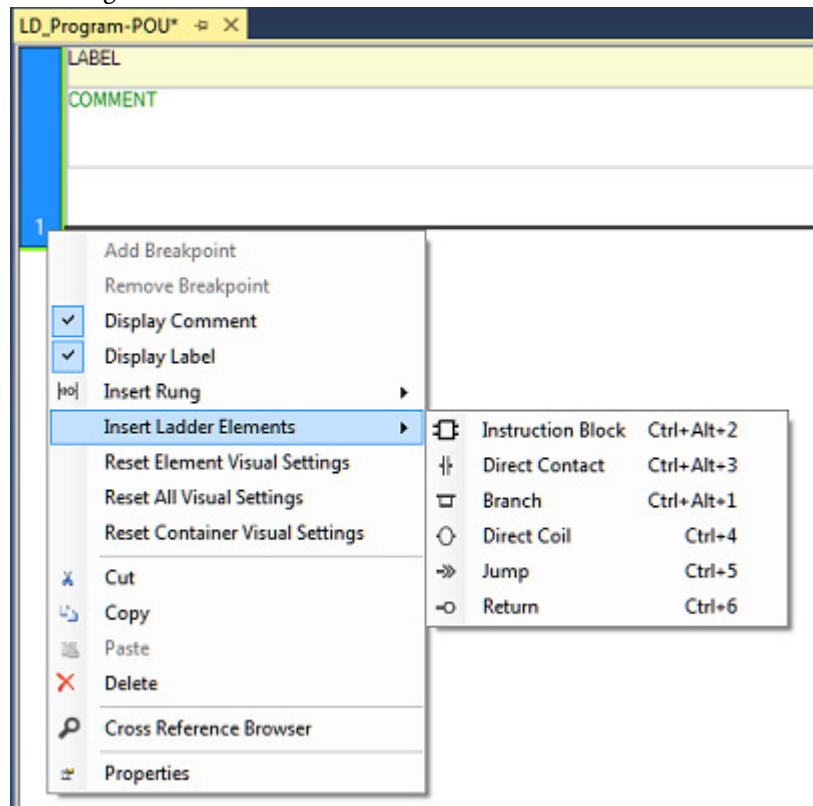

- Select a rung or an element in the LD language editor, and then press **CTRL+4** to add the **Direct Coil** to the right side of the rung.
- Select a rung or an element in the LD language editor, and then click **Tools > Multi-language Editor > Insert Coil** to add the coil to the right side of the rung.
- Open the LD Toolbox to show the coil elements (**Direct Coil**, **Reverse Coil**, **Set Coil**, **Reset Coil**, **Pulse Rising Edge Coil**, **Pulse Falling Edge Coil**) and then either:

Double-click the coil element to add it to the LD language editor.



Drag the coil element into the LD language editor and position it on the rung.

A plus sign (+) appears in the LD language editor to show a valid target. Release the mouse button to add the element.

1. (optional) To insert a parallel coil
  - a. In the LD language editor, verify the LD program has a defined branch and then right-click the top level of the [branch](#) on [page 36](#) to open the LD language editor menu.

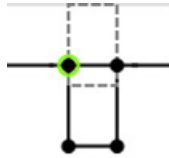

- b. From the LD language editor menu, select **Insert Ladder Elements** and then click **Direct Coil**. The element is inserted on the top level of the branch.

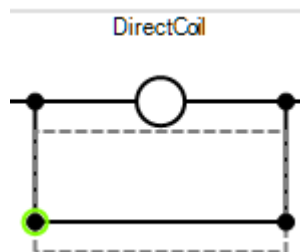

- c. Right-click the bottom level of the branch to open the LD language editor menu.
  - d. From the LD language editor menu, select **Insert Ladder Elements** and then click **Direct Coil**. The element is inserted on the bottom level of the branch.

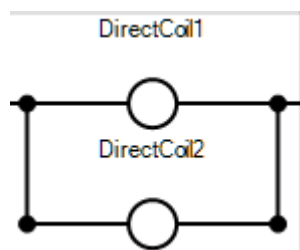

2. (optional) To change the type of coil, in the LD language editor select the coil, and then press the **space bar** until the coil type displays in the language editor.

Every time the space bar is pressed the coil type changes from direct, to reverse, to set, to reset, to pulse rising edge, to pulse falling edge.

## Direct Coil

[Coils](#) on [page 39](#) are graphic components of Ladder Diagram (LD) programs that represent the assignment of an output or of an internal variable.

A direct coil supports a Boolean output of a connection line Boolean state.

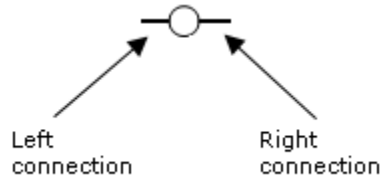

The associated variable is assigned with the Boolean state of the left connection. The state of the left connection is propagated into the right connection. The right connection must be connected to the right vertical power rail (unless you have parallel coils, where only the upper coil must be connected to the right vertical power rail).

The associated Boolean variable must be an output or it must be user-defined.

### Direct coil example



## Reverse Coil

[Coils](#) on [page 39](#) are graphic components of Ladder Diagram (LD) programs that represent the assignment of an output or of an internal variable.

A reverse coil element supports a Boolean output according to the Boolean negation of a connection line state.

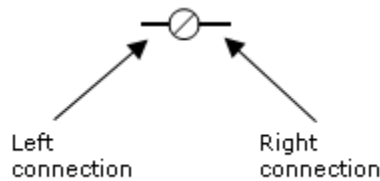

The associated variable is assigned with the Boolean negation of the state of the left connection. The state of the left connection is propagated into the right connection. The right connection must be connected to the right vertical power rail (unless you have parallel coils, where only the upper coil must be connected to the right vertical power rail).

The associated Boolean variable must be output or it must be user-defined.

**Reverse Coil example**



**Pulse Falling Edge Coil**

Coils on [page 39](#) are graphic components of Ladder Diagram (LD) programs that represent the assignment of an output or of an internal variable.

[Pulse falling edge](#) on [page 43](#) (or negative) coils support a Boolean output of a connection line Boolean state.

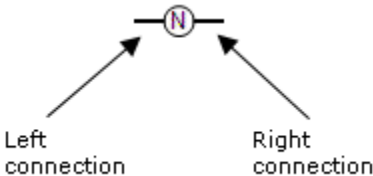

The associated variable is set to TRUE when the Boolean state of the left connection falls from TRUE to FALSE. The output variable resets to FALSE in all other cases. The state of the left connection is propagated into the right connection. The right connection must be connected to the right vertical power rail (unless you have parallel coils, where only the upper coil must be connected to the right vertical power rail).

The associated Boolean variable must be output or it must be user-defined.

**Pulse Falling Edge Coil example**



**Pulse Rising Edge Coil**

Coils on [page 39](#) are graphic components of Ladder Diagram (LD) programs that represent the assignment of an output or of an internal variable.

Pulse rising edge (or positive) coils support a Boolean output of a connection line Boolean state.

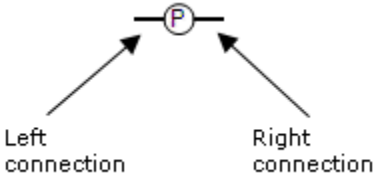

The associated variable is set to TRUE when the Boolean state of the left connection rises from FALSE to TRUE. The output variable resets to FALSE in all other cases. The state of the left connection is propagated into the right connection. The right connection must be connected to the right vertical power rail (unless you have parallel coils, where only the upper coil must be connected to the right vertical power rail).

The associated Boolean variable must be output or user-defined.

### Pulse Rising Edge Coil example



## Set Coil

Coils are graphic components of Ladder Diagram (LD) programs that represent the assignment of an output or of an internal variable. In LD programs, a coil represents an action.

Set coils support a Boolean output of a connection line Boolean state.

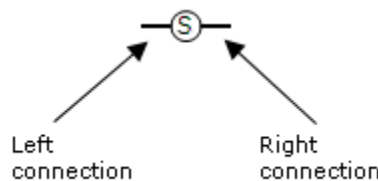

The associated variable is set to TRUE when the Boolean state of the left connection becomes TRUE. The output variable keeps this value until an inverse order is made by a Reset coil. The state of the left connection is propagated into the right connection. The right connection must be connected to the right vertical power rail (unless you have parallel coils, where only the upper coil must be connected to the right vertical power rail).

The associated Boolean variable must be output or it must be user-defined.

### Set Coil example

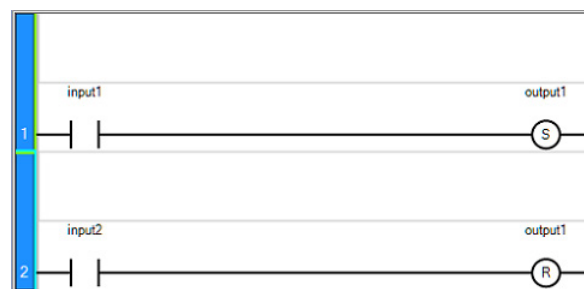

## Reset Coil

Coils on page 39 are graphic components of Ladder Diagram (LD) programs that represent the assignment of an output or of an internal variable.

Reset coils support a Boolean output of a connection line Boolean state.

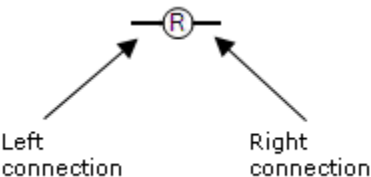

The associated variable is reset to FALSE when the Boolean state of the left connection becomes TRUE. The output variable keeps this value until an inverse order is made by a Set coil. The state of the left connection is propagated into the right connection. The right connection must be connected to the right vertical power rail (unless you have parallel coils, where only the upper coil must be connected to the right vertical power rail).

The associated Boolean variable must be output or user-defined.

### Reset Coil example



## Contact

Contacts are graphic components of Ladder Diagram (LD) programs. Depending on the type, a contact represents the value or function of an input or of an internal variable. Contacts can only be added to a defined rung in the LD language editor. After a contact is added, its definition can be modified.

The following example shows the contact element types available for Ladder Diagram programs.

### Example: Contacts

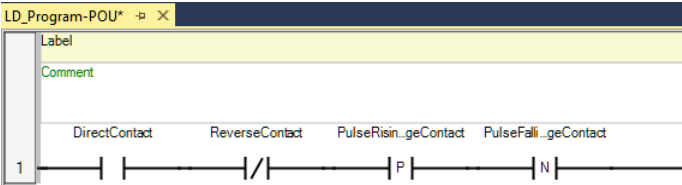

## Add a contact to a LD program

Contacts are graphic components of a Ladder Diagram (LD) program. Depending on the type, a contact represents the value or function of an input or of an internal variable. Contacts can only be added to a defined rung in the LD language editor.

In Connected Components Workbench, you can add a contact to a Ladder Diagram (LD) program from the:

- Ladder Diagram (LD) language editor
- Multi-language Editor located on the Tools menu
- LD Toolbox
- Instruction Toolbar (LD)

### To add a contact element to a Ladder Diagram program

1. In the LD language editor, verify the LD program has a defined rung for the contact. Then do one of the following:

- Right-click a rung or an element in the LD language editor, select **Insert Ladder Elements** and then click **Direct Contact**.

If the **Variable Selector** opens, select a variable or click **OK** without selecting a variable to add the **Direct Contact** element.

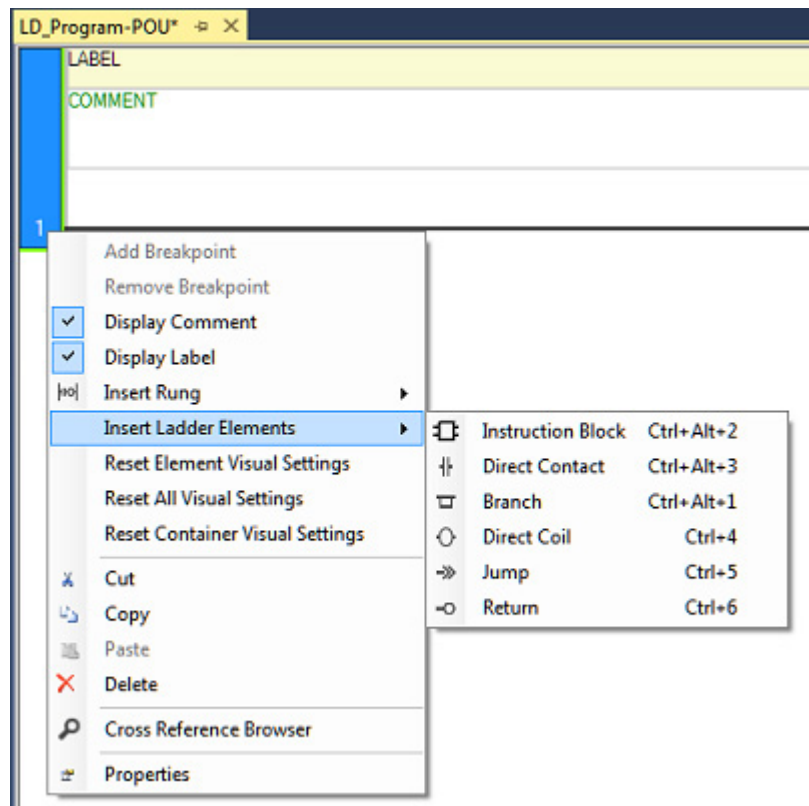

- Select a rung or an element in the LD language editor, and then press either:

**CTRL+ALT+3** to add the Direct Contact element to the left side of the selected element or the rung.

**CTRL+3** to add the Direct Contact element to the right side of the selected element or the rung.

- Select a rung or an element in the LD language editor and then either:
  - Click **Tools > Multi-language Editor > Insert Contact Before** to add the contact to the left side of the selected element or rung.
  - Click **Tools > Multi-language Editor > Insert Contact After** to add the contact to the right side of the selected element or rung.
- Open the LD Toolbox to show the contact elements (**Direct Contact, Reverse Contact, Pulse Rising Edge Contact, Pulse Falling Edge Contact**) and then either:
  - Double-click the contact element to add it to the LD language editor.
  - Drag the contact element into the LD language editor and position it on the rung.
  - A plus sign (+) appears in the LD language editor to show a valid target. Release the mouse button to add the element.

1. (optional) To insert a parallel contact:

- In the LD language editor, verify the LD program has a defined [branch](#) on [page 36](#) and then right-click the top level of the branch to open the LD language editor menu.

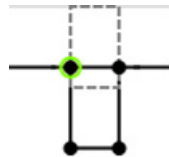

- From the LD language editor menu, select **Insert Ladder Elements** and then click **Direct Contact**. The element is inserted on the top level of the branch.

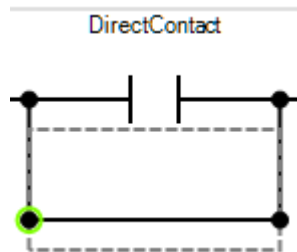

- Right-click the bottom level of the branch to open the LD language editor menu.

- d. From the LD language editor menu, select **Insert Ladder Elements** and then click **Direct Contact**. The element is inserted on the bottom level of the branch.

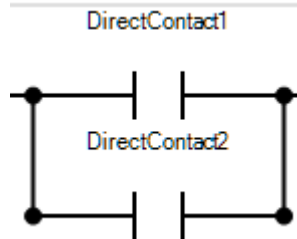

- 2. (optional) To change the type of contact, in the language editor select the contact, and then press the **space bar** until the the contact type displays in the language editor.

Every time the space bar is pressed the contact type changes from direct, to reverse, to pulse rising edge, to pulse falling edge.

## Direct Contact

[Contacts](#) on [page 45](#) are graphic components of Ladder Diagram (LD) programs.

Direct contacts support a Boolean operation between a connection line state and a Boolean variable.

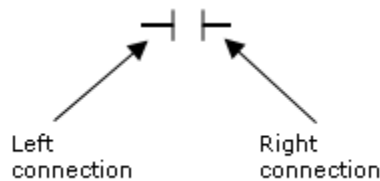

The state of the connection line on the right of the contact is the logical AND between the state of the left connection line and the value of the variable associated with the contact.

## Direct Contact example



## Reverse Contact

[Contacts](#) on [page 45](#) are graphic components of Ladder Diagram (LD) programs.



Reverse contacts support a Boolean operation between a connection line state and the Boolean negation of a Boolean variable.

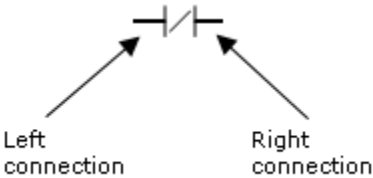

The state of the connection line on the right of the contact is the logical AND between the state of the left connection line and the Boolean negation of the value of the variable associated with the contact.

**Reverse Contact example**

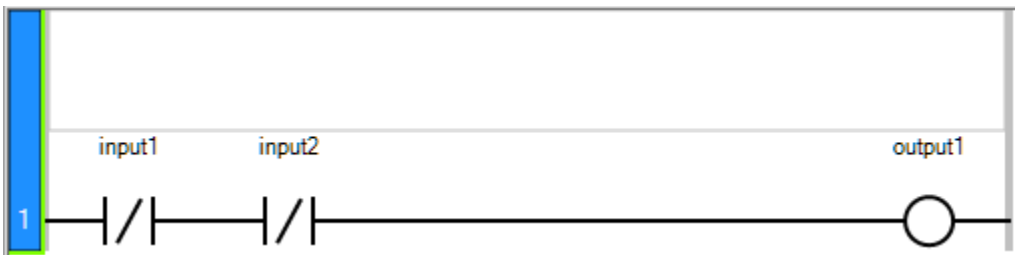

**Pulse Rising Edge Contact**

[Contacts](#) on [page 45](#) are graphic components of Ladder Diagram (LD) programs.

Pulse rising edge (or positive) contacts support a Boolean operation between a connection line state and the rising edge of a Boolean variable.

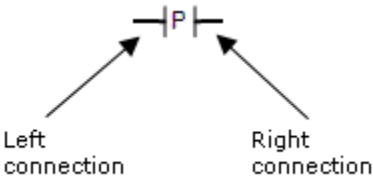

The state of the connection line on the right of the contact is set to TRUE when the state of the connection line on the left is TRUE, and the state of the associated variable rises from FALSE to TRUE. The state is reset to FALSE in all other cases.

**Pulse Rising Edge Contact example**

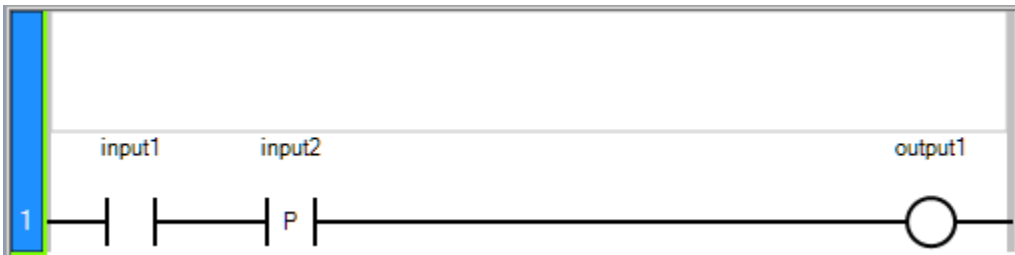

### Recommendation: Restrict the use of output variables with edge contacts

We recommend not using outputs or variables with a [Pulse rising edge contact](#) on [page 49](#) (positive) or a [Pulse falling edge contact](#) on [page 50](#) (negative). These contacts are for physical inputs in a ladder diagram. To detect the edge of a variable or an output, we recommend using the R\_TRIG/F\_TRIG function block, which is supported and works in any language at any location in your program.

### Pulse Falling Edge Contact

Contacts are graphic components of Ladder Diagram (LD) programs.

Pulse falling edge (or negative) contacts support a Boolean operation between a connection line state and the falling edge of a Boolean variable.

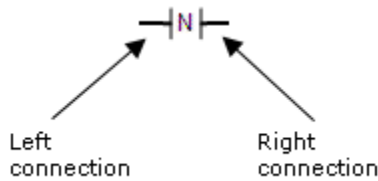

The state of the connection line on the right of the contact is set to TRUE when the state of the connection line on the left is TRUE, and the state of the associated variable falls from TRUE to FALSE. The state is reset to FALSE in all other cases.

### Pulse Falling Edge Contact example

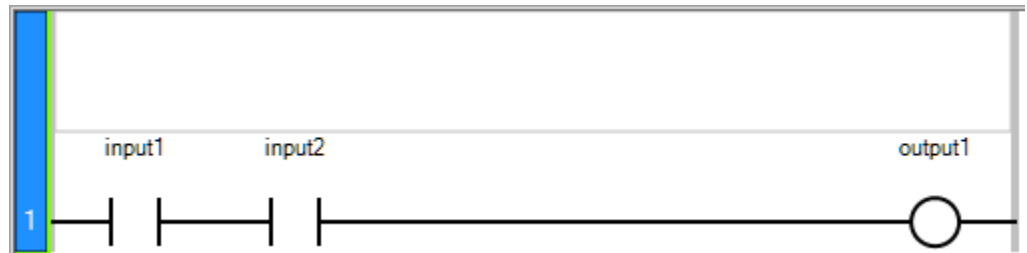

### Recommendation: Restrict the use of output variables with edge contacts

We recommend not using outputs or variables with a [Pulse rising edge contact](#) on [page 49](#) (positive) or a [Pulse falling edge contact](#) on [page 50](#) (negative). These contacts are for physical inputs in a ladder diagram. To detect the edge of a variable or an output, we recommend using the R\_TRIG/F\_TRIG function block, which is supported and works in any language at any location in your program.

### Return

Returns are outputs that represent a conditional end of a Ladder Diagram (LD) program.

You cannot place connections to the right of a return element.

When the left connection line has the TRUE Boolean state, the diagram ends without executing the instructions located on the next lines of the diagram.

When the LD diagram is a function, its name is associated with an output coil to set the return value (returned to the calling diagram).

### Return example

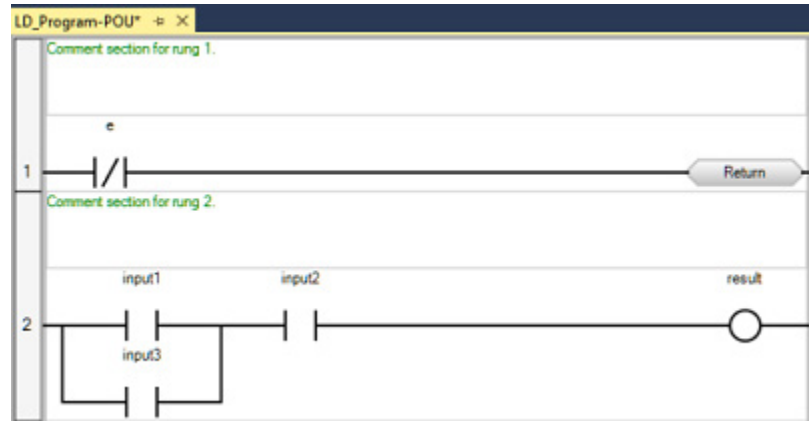

### To insert a return in a Ladder Diagram program

Do one of the following:

- Right-click a rung or an element in the LD language editor, select **Insert Ladder Elements** and then click **Return**.
- Select a rung or element in the LD language editor and then press **CTRL+6**.
- Select a rung or an element in the LD language editor and then click **Tools > Multi-language Editor > Insert Return**.
- Open the LD Toolbox to show the return element and then either:
  - Double-click the return element to add it to the LD language editor.
  - Drag the return element into the LD language editor and position it on the rung.
 A plus sign (+) appears in the LD language editor to show a valid target. Release the mouse button to add the element.

## Jump

Jumps are conditional or unconditional elements that control the execution of Ladder Diagram (LD) programs.

### Jump notation

The following notation indicates a jump to a label:

**>>LABEL** - Jump to a label where the label name is "LABEL"

## Jump example

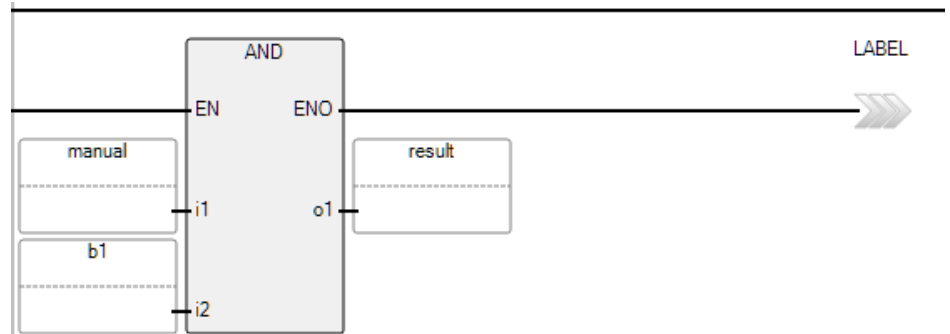

## To insert a jump

Do one of the following:

- Right-click a rung or an element in the LD language editor, select **Insert Ladder Elements** and then click **Jump**.
- Select a rung or element in the LD language editor and then press **CTRL+5**.
- Select a rung or an element in the LD language editor and then click **Tools > Multi-language Editor > Insert Jump**.
- Open the LD Toolbox to show the jump element and then either:
  - Double-click the jump element to add it to the LD language editor.
  - Drag the jump element into the LD language editor and position it on the rung.
 A plus sign (+) appears in the LD language editor to show a valid target. Release the mouse button to add the element.

## Instruction blocks in LD programs

The Connected Components Workbench instruction set includes IEC 61131-3 compliant instruction blocks. Instruction blocks collectively include function blocks, functions and operators. You can connect instruction block inputs and outputs to variables, contacts, coils, or other instruction block inputs and outputs.

## Instruction block conventions

The IEC61131-3 programming language specification addresses numerous aspects of programmable controllers including the operating system execution, data definitions, programming languages, and instruction sets. The IEC61131-3 specification provides a minimum set of functionalities that can be extended to meet end user applications.

## Instruction block names

Functions and function blocks are represented by a box that displays the name of the instruction, and the short version of the parameter names. For function blocks, the instance name is displayed above the function block name.

## Instruction block return parameters

- The return parameter of a function has the same name as the function. The return parameter is the only output.
- The return parameters of a function block can have any name. Multiple return parameters can provide multiple outputs.
- You can define the parameters of programs for multiple devices by navigating the tabs for individual devices displayed in the **Parameter** view.

## Work in the LD language editor

When you add items to a rung in the Ladder Diagram (LD) program, they are added according to the following criteria:

- The first element on a rung is inserted at the position you select in the ladder diagram.
- Subsequent elements are inserted to the right of the selected item on the rung.
- You cannot insert an element to the right of a coil return or jump.

Different methods to add an element to Ladder Diagram program:

- **LD Ladder Editor**
  - Add elements, delete elements, and copy and paste elements.
  - Use [LD keyboard shortcuts](#) on [page 55](#) to add elements.
- **LD Text Editor**
  - Add, modify and delete elements.
  - Copy and paste elements from/to RSLogix 500 and <RSLX5000>.
- **Multi-language Editor** located on the **Tools** menu
  - Add elements.
  - Export an image of the LD program.
  - Enable or disable the automatic opening of the **Variable Selector** and **Instruction Block Selector**.
- **LD Toolbox**
  - Add elements.
- **Instruction Toolbar**
  - Add elements.

You can replace an assigned variable directly from the language editor, or from the **Variable Selector**.

### To modify a variable from the language editor

1. In the language editor, click the variable name to display a drop-down list of global and local variables.
2. Do one of the following:
  - Enter a new variable name and double-click the variable to open **Variable Selector**. Press **Enter** to confirm the new variable.
  - Select a different variable name from the drop-down list.

### To modify a variable from the Variable Selector

1. In the language editor, double-click the variable to open the **Variable Selector**.
2. Click the variable name, then select a different variable from the drop-down list of global and local variables.
3. Click an existing variable, then type constant values in the text box provided.

## Ladder Diagram (LD) program examples

The following examples are Ladder Diagram (LD) programs.

### Example: R\_TRIG function block

The following example program shows the recommended usage of an R\_TRIG function block used to detect an edge while connected to the controller.

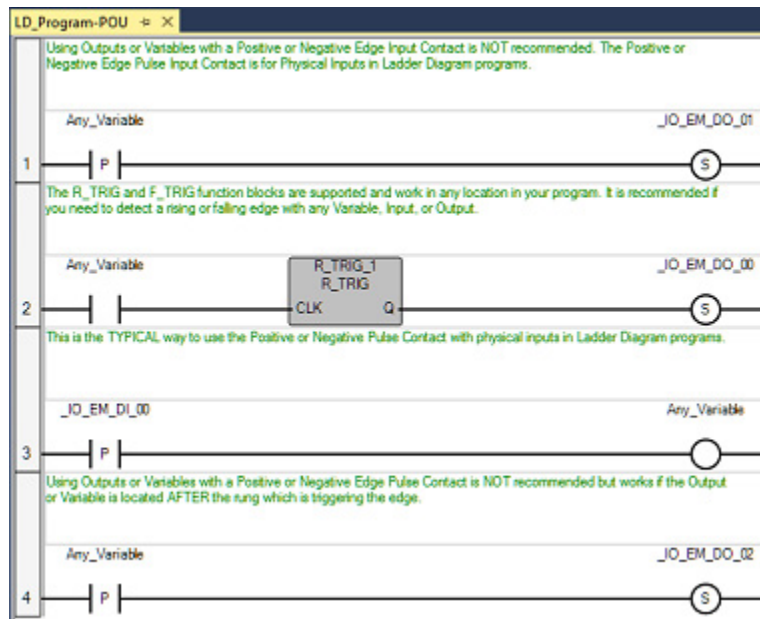

## Example: Comparing Real Values using Subtraction (-) ABS, and Less than (<)

The Real data type is not recommended when comparing values for equality because of differences in the way numbers are rounded. Two output values may appear equal in a Connected Components Workbench display, but will evaluate as false.

For example, 23.500001 compared to 23.499999 will both display as 23.5 in the variable input display, but will not be equal in the controller.

To test whether two Real data type values are equal, you can use a Subtraction instruction to get the difference between the values and then determine if the difference is Less Than an established precision value. See the following LD program example for comparing two Real data type values.

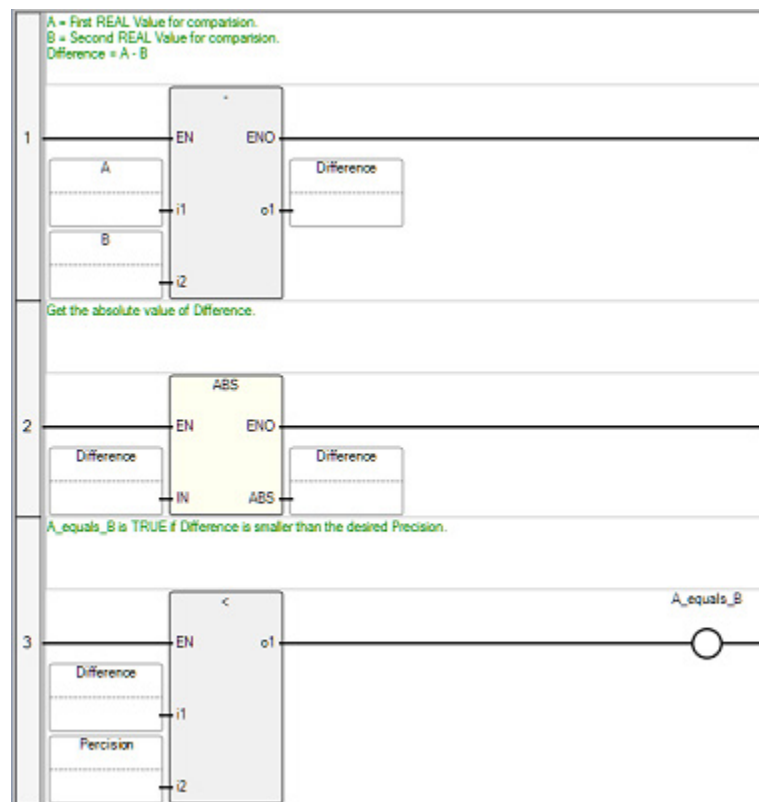

### LD Keyboard shortcuts

The following keyboard shortcuts are available for use with the [Ladder Diagram language](#) on [page 29](#).

Shortcut	Description
Ctrl+0	Inserts a rung after a selected rung. <sup>1</sup>
Ctrl+Alt+0	Inserts a rung before a selected rung. <sup>1</sup>
Ctrl+ 1	Inserts a branch after a selected element.
Ctrl+Alt+ 1	Inserts a branch before a selected element.
Ctrl+2	Inserts an instruction block after a selected element. <sup>2</sup>
Ctrl+Alt+2	Inserts an instruction block before a selected element. <sup>2</sup>
Ctrl+3	Inserts a contact after a selected element. <sup>2</sup>

<b>Shortcut</b>	<b>Description</b>
Ctrl+Alt+3	Inserts a contact before a selected element. <sup>2</sup>
Ctrl+4	Inserts a coil after a selected element.
Ctrl+5	Inserts a jump after a selected element.
Ctrl+Alt+5	Inserts a jump after a selected element.
Ctrl+6	Inserts a return after a selected element.
Ctrl+8	Inserts a branch above the selected branch.
Ctrl+Alt+8	Inserts a branch below the selected branch.
Delete	Removes a selected rung or element.
Enter	When a rung is selected, pressing the Enter key selects the first element of the rung. If there is no rung element, nothing happens.
Spacebar	When a coil or contact is selected, pressing the Spacebar changes the contact or coil type.
Shift+Enter	Inserts a line break.
Ctrl+Enter	Opens a line above the current line.
Ctrl+Shift+Enter	Opens a line below the current line.
Ctrl+Shift+L	Removes the current line.
Ctrl+Delete	Removes the next word in the current line.
Backspace	Removes the character on the left.
Ctrl+Backspace	Removes the previous word in the current line.
Ctrl+C	Copies the selected text to the clipboard.
Ctrl+Insert	Copies the selected text to the clipboard.
Ctrl+V	Pastes text saved on the clipboard to the insertion point.
Shift+Insert	Pastes text saved on the clipboard to the insertion point.
Ctrl+Z	Undoes the previous command.
Ctrl+Y	Redoes the previous command.
Ctrl+Shift+Z	Redoes the previous command.
Ctrl+Left	Moves to the previous statement or word.
Ctrl+Right	Moves to the next statement or word.
Home	Moves to the first element of the selected rung, if there is no rung element nothing happens.
End	Moves to the last element of the selected rung, if there is no rung element nothing happens.
Ctrl+Home	Moves to the first element of the first rung, if there is no rung element, the first rung is selected.
Ctrl+End	Moves to the last element of the last rung, if there is no rung element, the last rung is selected.
Page Up	Moves to the top of the visible code.
Page Down	Moves to the bottom of the visible code.
Ctrl+J	Moves to the matching bracket.
Ctrl+Down	Scrolls down.
Ctrl+Up	Scrolls up.
Shift+Down	Selects down.
Shift+Left Mouse Click	Selects multiple rungs. Click each rung individually.
Shift+Up	Selects up.
Shift+Left	Selects left.
Shift+Right	Selects right.



Shortcut	Description
Ctrl+Shift+Left	Selects to the previous statement or word.
Ctrl+Shift+Right	Selects to the next statement or word.
Shift+Home	Selects from the insertion point until the start of the line.
Shift+End	Selects from the insertion point until the end of the line.
Ctrl+Shift+Home	Selects from the insertion point until the start of the document.
Ctrl+Shift+End	Selects from the insertion point until the end of the document.
Shift+Page Up	Selects from the insertion point until the top of the visible code.
Shift+Page Down	Selects from the insertion point until the end of the visible code.
Ctrl+Shift+Page Up	Selects from the insertion point until the top of the visible code.
Ctrl+Shift+Page Down	Selects from the insertion point until the end of the visible code.
Ctrl+A	Selects the entire document.
Ctrl+D	When a rung or one element of the rung is selected, after pressing CTRL+D user can edit rung comment.
Ctrl+R	Enable or disable the Automatic Selector Invocation. By default, either the Instruction Block Selector or Variable Selector dialog opens when an element is added to a Ladder Diagram program.
Ctrl+Shift+W	Selects the next word.
Ctrl+Shift+J	Selects to the matching bracket.
Shift+Alt+Down	Selects the current and next lines.
Shift+Alt+Up	Selects the current and previous lines.
Shift+Alt+Left	Selects left on the current line.
Shift+Alt+Right	Selects right on the current line.
Ctrl+Shift+Alt+ Left	Selects available columns in lines of code from the left to right.
Ctrl+Shift+Alt+Right	Selects available columns in lines of code from the right to left.
Esc	Deselects the selected text.
Insert	Toggles between the overwrite/insert typing mode.

<sup>1</sup>When no rung is selected, a rung is added at the end of the rung list.

<sup>2</sup>When a branch is selected, an element is inserted at the end of the branch.



## Alarm instruction

Use the alarm instruction to provide alerts when a configured high or low limit is reached.

Function block	Description
<a href="#">LIM_ALARM</a> on <a href="#">page 59</a>	Hysteresis on a real value for high and low limits.

### LIM\_ALARM (limit alarm)

LIM\_ALARM is an alarm with hysteresis on a Real value for high and low limits.

A hysteresis is applied on high and low limits. The hysteresis delta used for either high or low limit is one half of the EPS parameter.

A Process alarm is an alarm that occurs when a fault is received and processed by the controller. Process level alarms provide an alert when the module has exceeded the configured high or configured low limits for each channel.

Languages supported: Function Block Diagram, Ladder Diagram, Structured Text.

This instruction applies to the Micro810, Micro820, Micro830, Micro850, Micro870 controllers and Micro800 Simulator.

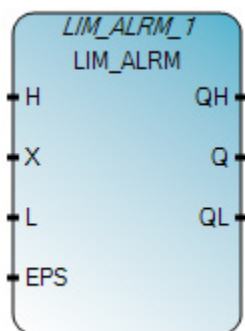

Use this table to help determine the parameter values for this instruction.

Parameter	Parameter type	Data type	Description
EN	Input	BOOL	When TRUE, enables the instruction block. TRUE - execute current LIM_ALARM computation. FALSE - there is no computation. Applies only to Ladder Diagram programs.
H	Input	REAL	High limit value.
X	Input	REAL	Input is any real value.
L	Input	REAL	Low limit value.
EPS	Input	REAL	Hysteresis value (must be greater than zero).
QH	Output	BOOL	High alarm: TRUE if X above high limit H.

Q	Output	BOOL	Alarm output: TRUE if X out of limits.
QL	Output	BOOL	Low alarm: TRUE if X below low limit L.
ENO	Output	BOOL	Enables outputs. Applies only to Ladder Diagram programs.

**LIM\_ALARM timing diagram example**

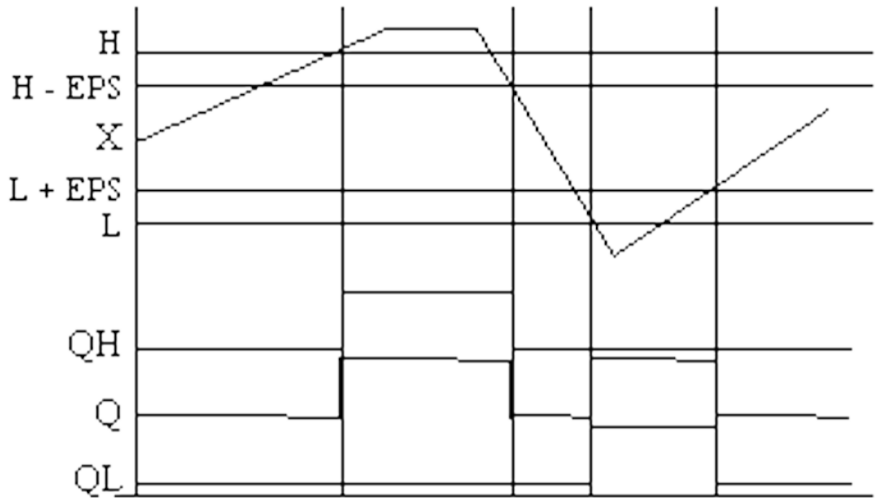

**LIM\_ALARM Function Block Diagram example**

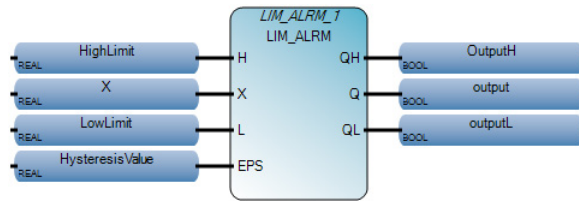

**LIM\_ALARM Ladder Diagram example**

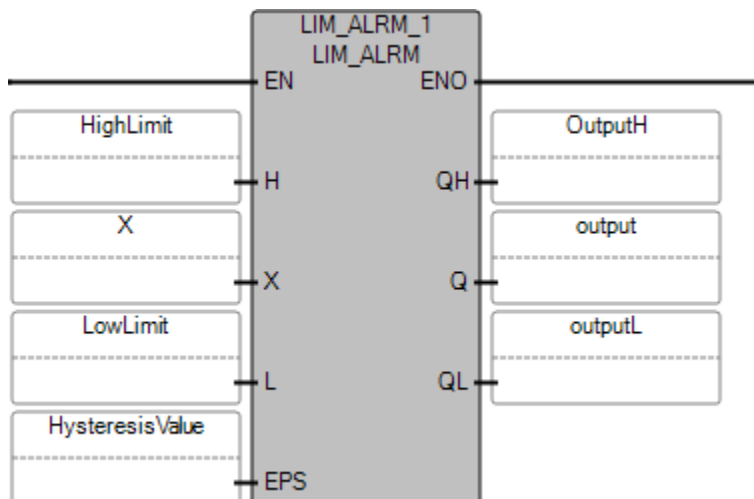

## LIM\_ALARM Structured Text example

```
LIM_ALARM_1{
```

```
void LIM_ALARM_1(REAL H, REAL X, REAL L, REAL EPS)  
Type : LIM_ALARM, High/low limit alarm with hysteresis
```

```
1 HighLimit := 10.0;  
2 X := 15.0;  
3 LowLimit := 5.0;  
4 HysteresisValue := 2.0;  
5 LIM_ALARM_1(HighLimit, X, LowLimit, HysteresisValue);  
6 OutputH := LIM_ALARM_1.QH;  
7 OutputL := LIM_ALARM_1.QL;  
8 output := LIM_ALARM_1.Q;
```

## Results

Variable Monitoring

User Global Variables - Micro870		Local Variables - Prog1		System Variables - Micro870		I/O - Micro870		Defined Words	
Name	Alias	Logical Value	Physical Value	Initial Value	Lock	Data Type	Dir		
X		15.0	N/A		<input type="checkbox"/>	REAL			
HysteresisValue		2.0	N/A		<input type="checkbox"/>	REAL			
HighLimit		10.0	N/A		<input type="checkbox"/>	REAL			
LowLimit		5.0	N/A		<input type="checkbox"/>	REAL			
OutputH		<input checked="" type="checkbox"/>	N/A		<input type="checkbox"/>	BOOL			
output		<input checked="" type="checkbox"/>	N/A		<input type="checkbox"/>	BOOL			
LIM_ALARM_1		...	...	...	<input type="checkbox"/>	LIM_ALARM			

Close



## Arithmetic instructions

Use the arithmetic instructions to perform mathematical calculations.

Function	Description
<a href="#">ABS</a> on <a href="#">page 63</a>	Returns the absolute value of a Real value.
<a href="#">ACOS</a> on <a href="#">page 65</a>	Calculates the arc-cosine of a Real value.
<a href="#">ACOS_LREAL</a> on <a href="#">page 66</a>	Calculates the arc-cosine of a Long Real value.
<a href="#">Addition</a> on <a href="#">page 68</a>	Adds two or more Integer, Real, Time, or String values.
<a href="#">ASIN</a> on <a href="#">page 69</a>	Calculates the arcsine of a Real value.
<a href="#">ASIN_LREAL</a> on <a href="#">page 71</a>	Calculates the arcsine of a Long Real value.
<a href="#">ATAN</a> on <a href="#">page 72</a>	Calculates the arctangent of a Real value.
<a href="#">ATAN_LREAL</a> on <a href="#">page 74</a>	Calculates the arctangent of a Long Real value.
<a href="#">COS</a> on <a href="#">page 75</a>	Calculates the cosine of a Real value.
<a href="#">COS_LREAL</a> on <a href="#">page 77</a>	Calculates the cosine of a Long Real value.
<a href="#">Division</a> on <a href="#">page 78</a>	Division of two Integer or Real values.
<a href="#">EXPT</a> on <a href="#">page 80</a>	Calculates the Real value of a base number raised to the power of the Integer exponent.
<a href="#">LOG</a> on <a href="#">page 82</a>	Calculates the logarithm (base 10) of a Real value.
<a href="#">MOD</a> on <a href="#">page 83</a>	Performs a Modulo calculation on Integer values.
<a href="#">MOV</a> on <a href="#">page 85</a>	Copies an input value to an output.
<a href="#">Multiplication</a> on <a href="#">page 86</a>	Multiplies two or more Integer or Real values.
<a href="#">Neg</a> on <a href="#">page 88</a>	Converts a value to a negative.
<a href="#">POW</a> on <a href="#">page 89</a>	Calculates the value of a Real number raised to a power of the Real exponent.
<a href="#">RAND</a> on <a href="#">page 91</a>	Calculates random integer values from a defined range.
<a href="#">SIN</a> on <a href="#">page 93</a>	Calculates the sine of a Real value.
<a href="#">SIN_LREAL</a> on <a href="#">page 94</a>	Calculates the sine of a Long Real value.
<a href="#">SQRT</a> on <a href="#">page 96</a>	Calculates the square root of a Real value.
<a href="#">Subtraction</a> on <a href="#">page 97</a>	Subtracts one Integer, Real or Time value from another Integer, Real or Time value.
<a href="#">TAN</a> on <a href="#">page 99</a>	Calculates the tangent of a Real value.
<a href="#">TAN_LREAL</a> on <a href="#">page 100</a>	Calculates the tangent of a Long Real value.
<a href="#">TRUNC</a> on <a href="#">page 102</a>	Truncates Real values, leaving just the Integer.

### ABS (absolute value)

Returns the absolute (positive) value of a Real value.

Languages supported: Function Block Diagram, Ladder Diagram, Structured Text.

This instruction applies to the Micro810, Micro820, Micro830, Micro850, Micro870 controllers and Micro800 Simulator.



Use this table to help determine the parameter values for this instruction.

Parameter	Parameter Type	Data Type	Description
EN	Input	BOOL	Instruction enable. TRUE - execute current absolute computation. FALSE - there is no computation. Applies to Ladder Diagram programs.
IN	Input	REAL	Any signed Real value.
ENO	Output	BOOL	Enable output. Applies to Ladder Diagram programs.
ABS	Output	REAL	Absolute value (always positive).

### ABS Function Block Diagram example

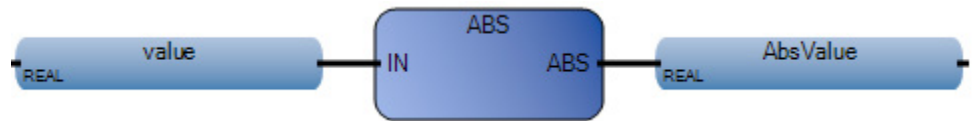

### ABS Ladder Diagram example

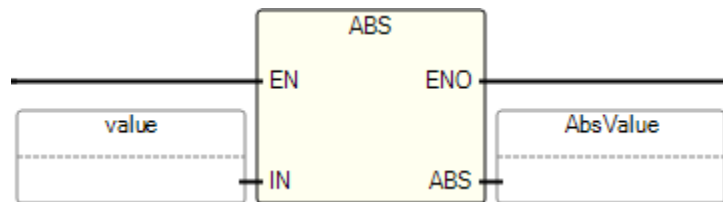

### ABS Structured Text diagram example

```

ABS (
  REAL ABS(REAL IN)
  Absolute value

1 | value := -1.0;
2 | AbsValue := ABS(value);

```

(\* ST Equivalence: \*)

over := (ABS (delta) > range);



## Results

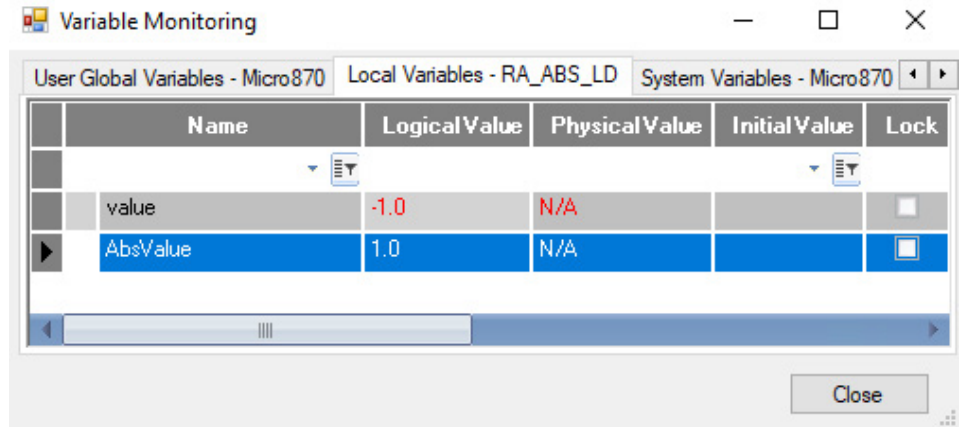

### ACOS (arccosine of source)

Calculates the arc-cosine of a Real value. Input and output values are in radians.

Languages supported: Function Block Diagram, Ladder Diagram, Structured Text.

This instruction applies to the Micro810, Micro820, Micro830, Micro850, Micro870 controllers and Micro800 Simulator.



Use this table to help determine the parameter values for this instruction.

Parameter	Parameter Type	Data Type	Description
EN	Input	BOOL	Instruction enable. TRUE - execute current arc-cosine computation. FALSE - there is no computation. Applies to Ladder Diagram programs.
IN	Input	REAL	Must be in set [-1.0 .. +1.0].
ENO	Output	BOOL	Enable output. Applies to Ladder Diagram programs.
ACOS	Output	REAL	Arc-cosine of the input value (in set [-p1/2..+p1/2])=0 for invalid input.

### ACOS Function Block Diagram example

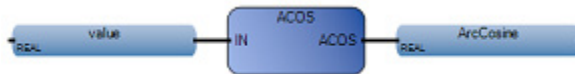

### ACOS Ladder Diagram example

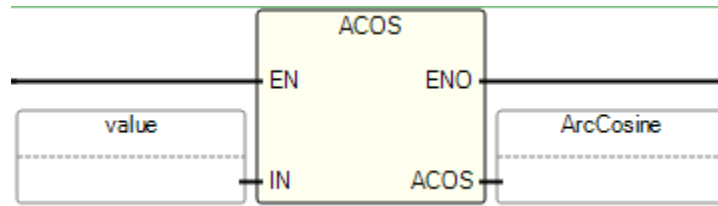

### ACOS Structured Text example

```

1 value := 0.5;
2 ArcCosine := ACOS(value);

```

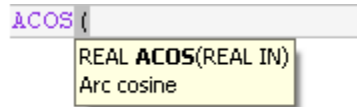

(\* ST Equivalence: \*)

cosine := COS (angle);

result := ACOS (cosine); (\* result is equal to angle \*)

### Results

Name	Logical Value	Physical Value	Initial Value	Lock
value	0.5	N/A		<input type="checkbox"/>
ArcCosine	1.0472	N/A		<input type="checkbox"/>

### ACOS\_LREAL (arccosine Long Real)

Calculates the arc-cosine of a Long Real value.

Languages supported: Function Block Diagram, Ladder Diagram, Structured Text.

This instruction applies to the Micro810, Micro820, Micro830, Micro850, Micro870 controllers and Micro800 Simulator.

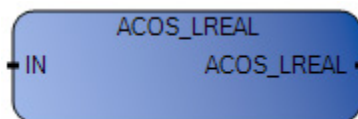

Use this table to help determine the parameter values for this instruction.

Parameter	Parameter Type	Data Type	Description
EN	Input	BOOL	Instruction enable. TRUE - execute current computation. FALSE - there is no computation. Applies to Ladder Diagram programs.
IN	Input	LREAL	Must be in set [-1.0 .. +1.0].
ENO	Output	BOOL	Enable output. Applies to Ladder Diagram programs.
ACOS_LREAL	Output	LREAL	Arc-cosine of the input value (in set [0.0 .. PI]) = 0.0 for invalid input.

### ACOS\_LREAL Function Block Diagram example

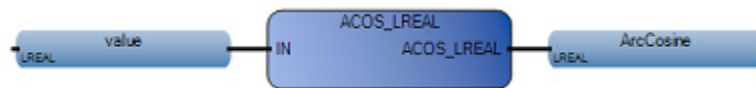

### ACOS\_LREAL Ladder Diagram examples

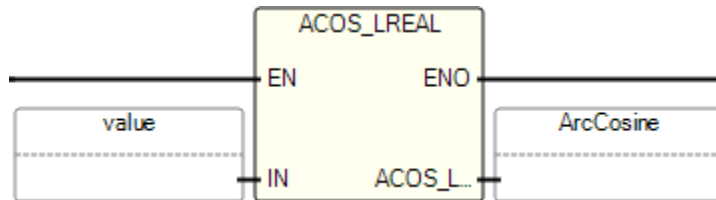

### ACOS\_LREAL Structured Text examples

```
ACOS_LREAL {
  LREAL ACOS_LREAL(LREAL IN)
  Perform 64-bit real arccosine calculation.
```

```
1 value := 0.5;
2 ArcCosine := ACOS_LREAL(value);
```

(\* ST Equivalence: \*)

cosine := COS\_LREAL (angle);

result := ACOS\_LREAL (cosine); (\* result is equal to angle \*)

## Results

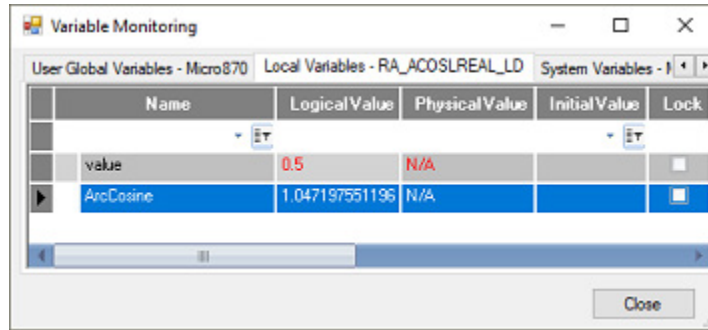

## Addition

Adds two or more Integer, Real, Time, or String values.

Languages supported: Function Block Diagram, Ladder Diagram, Structured Text.

This instruction applies to the Micro810, Micro820, Micro830, Micro850, Micro870 controllers and Micro800 Simulator.

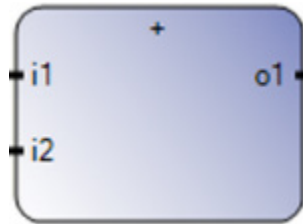

Use this table to help determine the parameter values for this instruction.

Parameter	Parameter Type	Data Type	Description
EN	Input	BOOL	Instruction enable. TRUE - execute current addition computation. FALSE - there is no computation. Applies only to Ladder Diagram programs.
i1	Input	SINT USINT BYTE INT UINT WORD DINT UDINT DWORD LINT ULINT LWORD REAL LREAL TIME STRING	Addend in Real, Time, or String data type. All inputs must be the same data type.

i2	Input	SINT USINT BYTE INT UINT WORD DINT UDINT DWORD LINT ULINT LWORD REAL LREAL TIME STRING	Addend in Real, Time, or String data type. All inputs must be the same data type.
o1	Output	SINT USINT BYTE INT UINT WORD DINT UDINT DWORD LINT ULINT LWORD REAL LREAL TIME STRING	Sum of the input values in Real, Time, or String format. Input and output must use the same data type.
ENO	Output	BOOL	Enable output. Applies only to Ladder Diagram programs.

### Addition Structured Text example

(\* ST equivalence: \*)

```
ao10 := ai101 + ai102;
ao5  := (ai51 + ai52) + ai53;
```

### ASIN (arcsine)

Calculates the arcsine of a Real value. Input and output values are in radians.

Languages supported: Function Block Diagram, Ladder Diagram, Structured Text.

This instruction applies to the Micro810, Micro820, Micro830, Micro850, Micro870 controllers and Micro800 Simulator.



Use this table to help determine the parameter values for this instruction.

Parameter	Parameter Type	Data Type	Description
EN	Input	BOOL	Instruction enable. TRUE - execute current arcsine computation. FALSE - there is no computation. Applies to Ladder Diagram programs.
IN	Input	REAL	Must be in set [-1.0 .. +1.0].
ASIN	Output	REAL	Arcsine of the input value(in set [-p1/2..+p1/2])=0 for invalid input.
ENO	Output	BOOL	Enable output. Applies to Ladder Diagram programs.

### ASIN Function Block Diagram example



### ASIN Ladder Diagram example

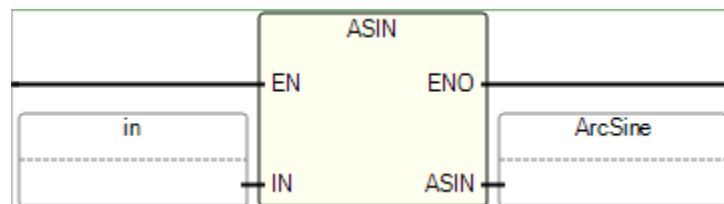

### ASIN Structured Text example

```

1 | in := 0.5;
2 | ArcSine := ASIN(in);

```

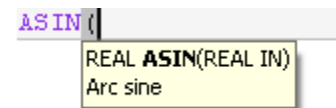

(\* ST Equivalence: \*)

sine := SIN (angle);

result := ASIN (sine); (\* result is equal to angle \*)

## Results

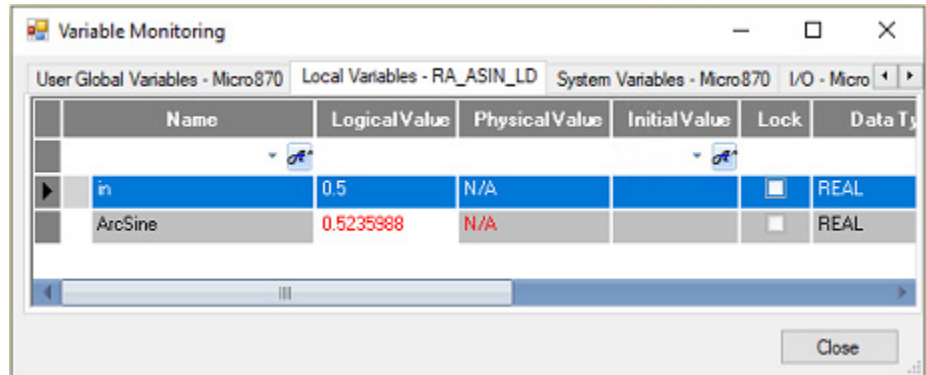

### ASIN\_LREAL (arcsine Long Real)

Calculates the arcsine of a Long Real value.

Languages supported: Function Block Diagram, Ladder Diagram, Structured Text.

This instruction applies to the Micro810, Micro820, Micro830, Micro850, Micro870 controllers and Micro800 Simulator.

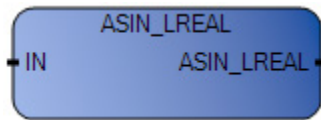

Use this table to help determine the parameter values for this instruction.

Parameter	Parameter Type	Data Type	Description
EN	Input	BOOL	Instruction enable. TRUE - execute current computation. FALSE - there is no computation. Applies to Ladder Diagram programs.
IN	Input	LREAL	Must be in set [-1.0 .. +1.0].
ASIN_LREAL	Output	LREAL	Arcsine of the input value (in set [-PI/2 .. +PI/2]) = 0.0 for invalid input.
ENO	Output	BOOL	Enable output. Applies to Ladder Diagram programs.

### ASIN\_LREAL Function Block Diagram example

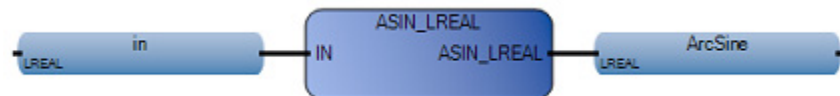

### ASIN\_LREAL Ladder Diagram example

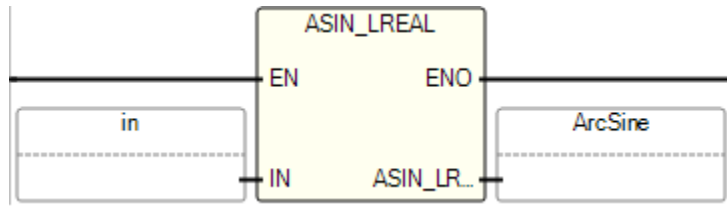

### ASIN\_LREAL Structured Text example

```

1 | in := 0.5;
2 | ArcSine := ASIN_LREAL(in);

```



(\* ST Equivalence: \*)

sine := SIN\_LREAL (angle);

result := ASIN\_LREAL (sine); (\* result is equal to angle \*)

### Results

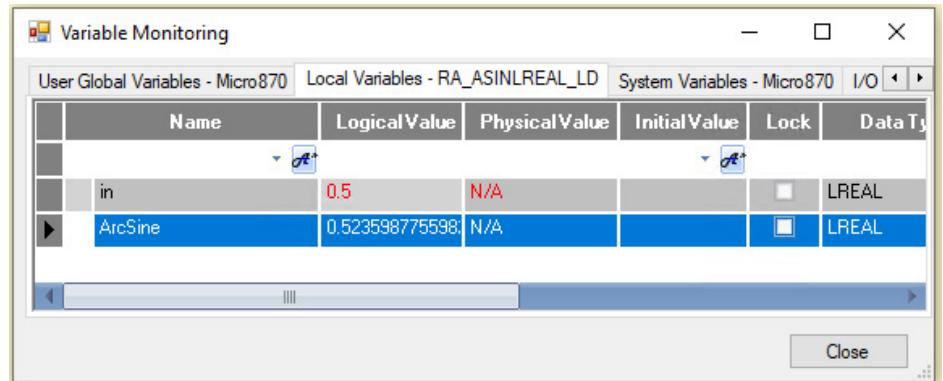

## ATAN (arctangent)

Calculates the arctangent of a Real value.

Languages supported: Function Block Diagram, Ladder Diagram, Structured Text.

This instruction applies to the Micro810, Micro820, Micro830, Micro850, Micro870 controllers and Micro800 Simulator.

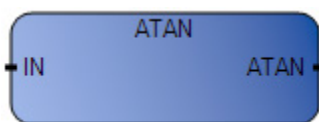

Use this table to help determine the parameter values for this instruction.



Parameter	Parameter Type	Data Type	Description
EN	Input	BOOL	Instruction enable. TRUE - execute current arctangent computation. FALSE - there is no computation. Applies to Ladder Diagram programs.
IN	Input	REAL	Any Real value.
ATAN	Output	REAL	Arctangent of the input value (in set $[-\pi/2 .. +\pi/2]$ ) = 0.0 for invalid input.
ENO	Output	BOOL	Enable output. Applies to Ladder Diagram programs.

### ATAN Function Block Diagram example

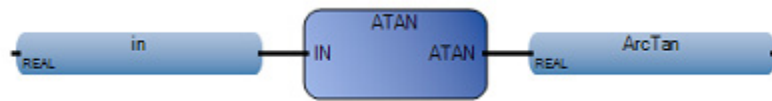

### ATAN Ladder Diagram example

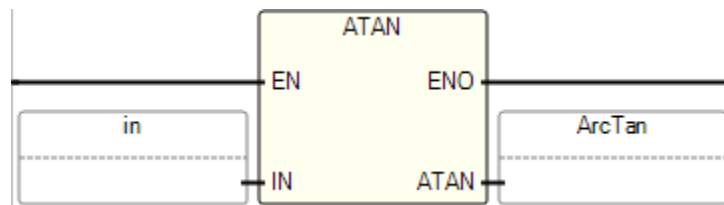

### ATAN Structured Text example

```

1 | in := 0.5;
2 | ArcTan := ATAN(in);

```

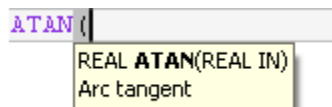

(\* ST Equivalence: \*)

tangent := TAN (angle);

result := ATAN (tangent); (\* result is equal to angle\*)

## Results

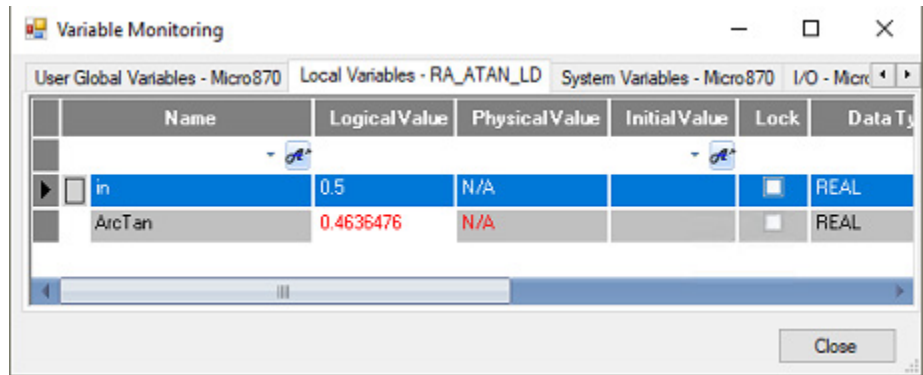

### ATAN\_LREAL (arctangent Long Real)

Calculates the arctangent of a Long Real value.

Languages supported: Function Block Diagram, Ladder Diagram, Structured Text.

This instruction applies to the Micro810, Micro820, Micro830, Micro850, Micro870 controllers and Micro800 Simulator.

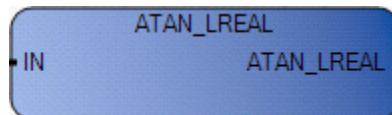

Use this table to help determine the parameter values for this instruction.

Parameter	Parameter Type	Data Type	Description
EN	Input	BOOL	Instruction enable. TRUE - execute current computation. FALSE - there is no computation. Applies to Ladder Diagram programs.
IN	Input	LREAL	Any Long Real value.
ATAN_LREAL	Output	LREAL	Arctangent of the input value (in set $[-\pi/2 .. +\pi/2]$ ) = 0.0 for invalid input.
ENO	Output	BOOL	Enable output. Applies to Ladder Diagram programs.

### ATAN\_LREAL Function Block Diagram example

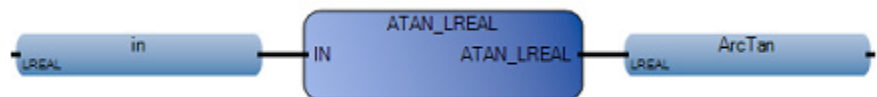

## ATAN\_LREAL Ladder Diagram example

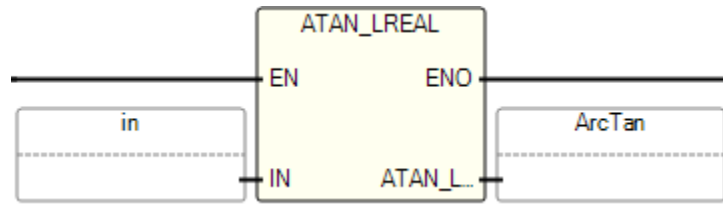

## ATAN\_LREAL Structured Text example

```
1 | in := 0.5;
2 | ArcTan := ATAN_LREAL(in);
```

`ATAN_LREAL` (  
 LREAL **ATAN\_LREAL**(LREAL IN)  
 Perform 64-bit real arctangent calculation.

(\* ST Equivalence: \*)

tangent := TAN\_LREAL (angle);

result := ATAN\_LREAL (tangent); (\* result is equal to angle\*)

## Results

Name	Logical Value	Physical Value	Initial Value	Lock	Data Type
in	0.5	N/A		<input type="checkbox"/>	LREAL
ArcTan	0.463647609000	N/A		<input type="checkbox"/>	LREAL

## COS (cosine)

Calculates the cosine of a Real value.

Languages supported: Function Block Diagram, Ladder Diagram, Structured Text.

This instruction applies to the Micro810, Micro820, Micro830, Micro850, Micro870 controllers and Micro800 Simulator.



Use this table to help determine the parameter values for this instruction.

Parameter	Parameter Type	Data Type	Description
EN	Input	BOOL	Instruction enable. TRUE - execute current cosine computation. FALSE - there is no computation. Applies to Ladder Diagram programs.
IN	Input	REAL	Any Real value.
COS	Output	REAL	Cosine of the input value (in set [-1.0 .. +1.0]).
ENO	Output	BOOL	Enable output. Applies to Ladder Diagram programs.

### COS Function Block Diagram example

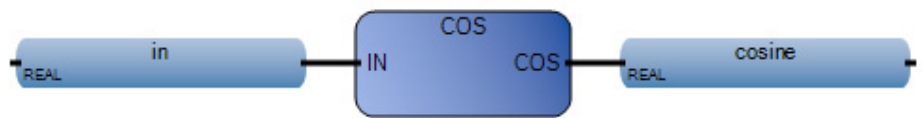

### COS Ladder Diagram example

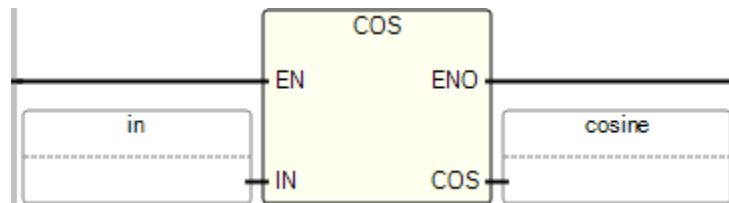

### COS Structured Text example

```
COS (|
REAL COS(REAL IN)
Cosine
```

```
1 in := 10.0;
2 cosine := COS(in);
```

(\* ST Equivalence: \*)

cosine := COS (angle);

result := ACOS (cosine); (\* result is equal to angle \*)

## Results

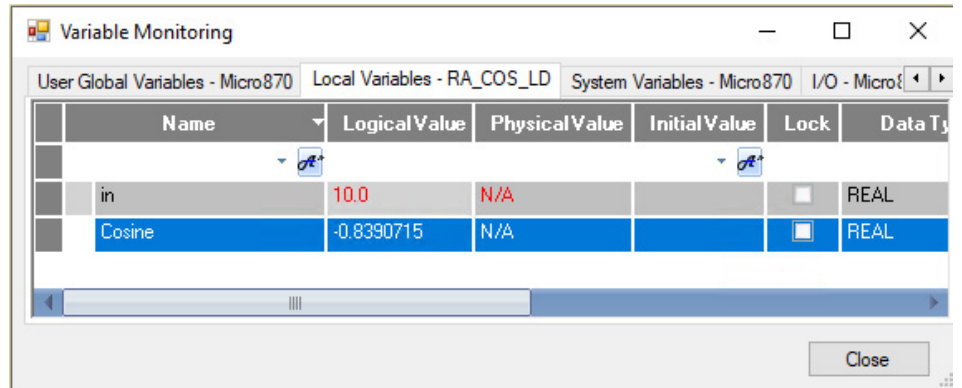

### COS\_LREAL (cosine Long Real)

Calculates the cosine of a Long Real value.

Languages supported: Function Block Diagram, Ladder Diagram, Structured Text.

This instruction applies to the Micro810, Micro820, Micro830, Micro850, Micro870 controllers and Micro800 Simulator.

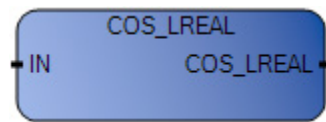

Use this table to help determine the parameter values for this instruction.

Parameter	Parameter Type	Data Type	Description
EN	Input	BOOL	Instruction enable. TRUE - execute current cosine computation. FALSE - there is no computation. Applies to Ladder Diagram programs.
IN	Input	LREAL	Any Long Real value.
COS_LREAL	Output	LREAL	Cosine of the input value (in set [-1.0 .. +1.0]).
ENO	Output	BOOL	Enable output. Applies to Ladder Diagram programs.

### COS\_LREAL Function Block Diagram example

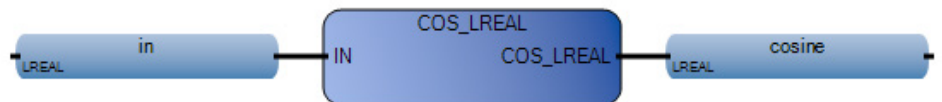

### COS\_LREAL Ladder Diagram example

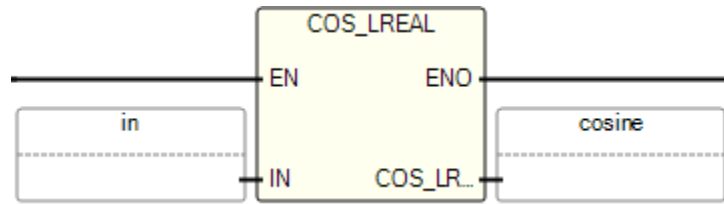

### COS\_LREAL Structured Text example

```
COS_LREAL (
    LREAL COS_LREAL(LREAL IN)
    Perform 64-bit real cosine calculation.
```

```
1 in := 10.0;
2 cosine := COS_LREAL(in);
```

(\* ST Equivalence: \*)

cosine := COS\_LREAL (angle);

result := ACOS\_LREAL (cosine); (\* result is equal to angle \*)

### Results

Name	Logical Value	Physical Value	Initial Value	Lock
in	10.0	N/A		<input type="checkbox"/>
Cosine	-0.83907152907645222	N/A		<input type="checkbox"/>

### Division

Divides the first Integer or Real input value by the second Integer or Real input value.

Languages supported: Function Block Diagram, Ladder Diagram, Structured Text.

This instruction applies to the Micro810, Micro820, Micro830, Micro850, Micro870 controllers and Micro800 Simulator.

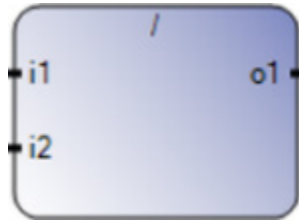

Use this table to help determine the parameter values for this instruction.

Parameter	Parameter Type	Data Type	Description
EN	Input	BOOL	Instruction enable. TRUE - execute current division computation. FALSE - there is no computation. Applies only to Ladder Diagram programs.
i1	Input	SINT USINT BYTE INT UINT WORD DINT UDINT DWORD LINT ULINT LWORD REAL LREAL	Dividend in non-zero Integer or Real data type. All inputs must be the same data type.
i2	Input	SINT USINT BYTE INT UINT WORD DINT UDINT DWORD LINT ULINT LWORD REAL LREAL	Divisor in non-zero Integer or Real data type. All inputs must be the same data type.

o1	Output	SINT USINT BYTE INT UINT WORD DINT UDINT DWORD LINT ULINT LWORD REAL LREAL	Quotient of the inputs in non-zero Integer or Real data type. Input and output must use the same data type.
ENO	Output	BOOL	Enable out. Applies only to Ladder Diagram programs.

### Division Structured Text example

(\* ST Equivalence: \*)

```
ao10 := ai101 / ai102;
ao5 := (ai5 / 2) / ai53;
```

### EXPT (exponent)

Raises the value of IN (base) to the power of EXP (exponent) and outputs the Real result of the operation.

Languages supported: Function Block Diagram, Ladder Diagram, Structured Text.

This instruction applies to the Micro810, Micro820, Micro830, Micro850, Micro870 controllers and Micro800 Simulator.

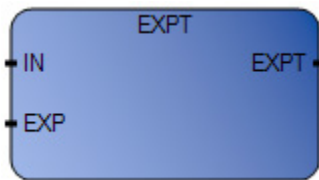

Use this table to help determine the parameter values for this instruction.

Parameter	Parameter Type	Data Type	Description
EN	Input	BOOL	Instruction enable. TRUE - execute current exponent computation. FALSE - there is no computation.
IN	Input	REAL	Any signed Real value.
EXP	Input	DINT	Integer exponent.
EXPT	Output	REAL	The Real value of IN to the power of EXP.
ENO	Output	BOOL	Enable output. Applies to Ladder Diagram programs.



### EXPT Function Block Diagram example

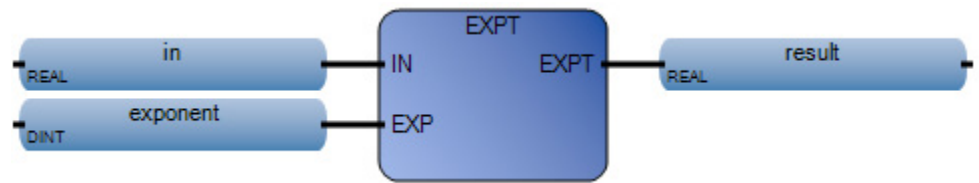

### EXPT Ladder Diagram example

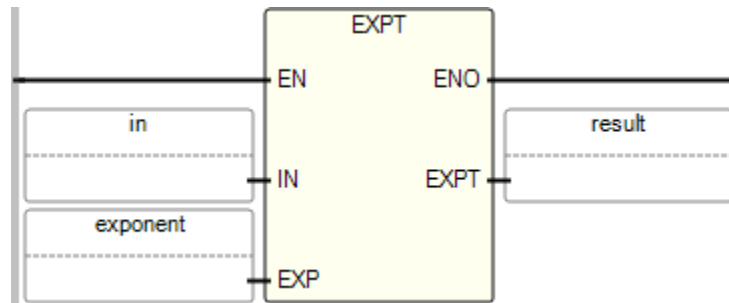

### EXPT Structured Text example

```

1 in := 2.0;
2 exponent := 3;
3 result := EXPT(in, exponent);

```

```

EXPT (
  REAL IN, DINT EXP
  Exponent
)

```

(\* ST Equivalence: \*)

```
tb_size := ANY_TO_DINT (EXPT (2.0, range));
```

### Results

Name	Alias	Logical Value	Physical Value	Initial Value
exponent		3	N/A	
in		2.0	N/A	
result		8.0	N/A	

## LOG (log base 10)

Calculates the logarithm (base 10) of a Real value.

Languages supported: Function Block Diagram, Ladder Diagram, Structured Text.

This instruction applies to the Micro810, Micro820, Micro830, Micro850, Micro870 controllers and Micro800 Simulator.



Use this table to help determine the parameter values for this instruction.

Parameter	Parameter Type	Data Type	Description
EN	Input	BOOL	Instruction enable. TRUE - execute current logarithm computation. FALSE - there is no computation.
IN	Input	REAL	Must be greater than zero.
LOG	Output	REAL	Logarithm (base 10) of the input value. The returned result is -3.4E+38 for a zero IN value and negative IN value.
ENO	Output	BOOL	Enable output. Applies to Ladder Diagram programs.

### LOG Function Block Diagram example

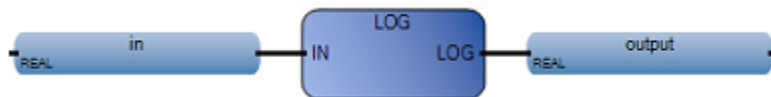

### LOG Ladder Diagram example

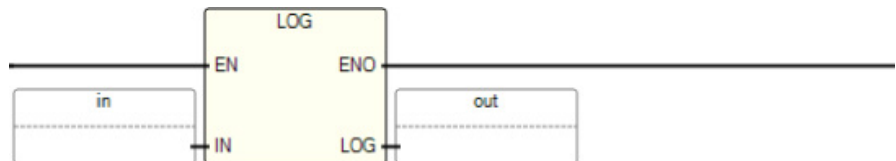

### LOG Structured Text example

```
1 | in := 10.0;
2 | output := LOG(in);
```

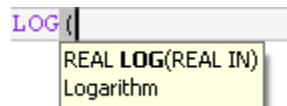

```
(* ST Equivalence: *)
xpos := ABS (xval);
xlog := LOG (xpos);
```

### Results

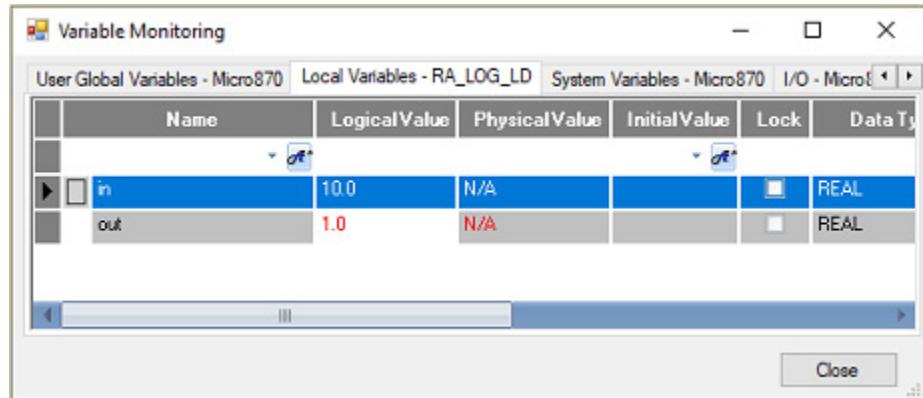

## MOD (modulo)

Divide the IN input by the Base input and place the remainder in the MOD output.

Languages supported: Function Block Diagram, Ladder Diagram, Structured Text.

This instruction applies to the Micro810, Micro820, Micro830, Micro850, Micro870 controllers and Micro800 Simulator.



Use this table to help determine the parameter values for this instruction.

Parameter	Parameter Type	Data Type	Description
EN	Input	BOOL	Instruction enable. TRUE - execute the module computation. FALSE - there is no computation. Applies to Ladder Diagram programs.
IN	Input	DINT	Any signed integer value.
Base	Input	DINT	Must be greater than zero.
MOD	Output	DINT	Modulo calculation (input MOD base) / returns -1 if Base <= 0.
ENO	Output	BOOL	Enable output. Applies to Ladder Diagram programs.

### MOD Function Block Diagram example



### MOD Ladder Diagram example

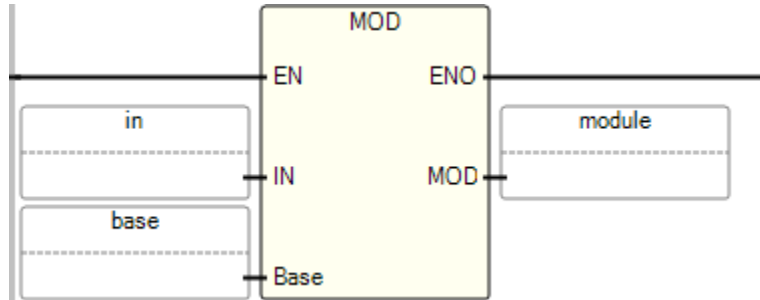

### MOD Structured Text example

```
MOD (
  DINT MOD(DINT IN, DINT Base)
  Modulo
```

```
1 in := 5;
2 base := 3;
3 module := MOD(in, base);
```

(\* ST Equivalence: \*)

division\_result := (value / divider); (\* integer division \*)

rest\_of\_division := MOD (value, divider); (\* rest of the division \*)

## Results

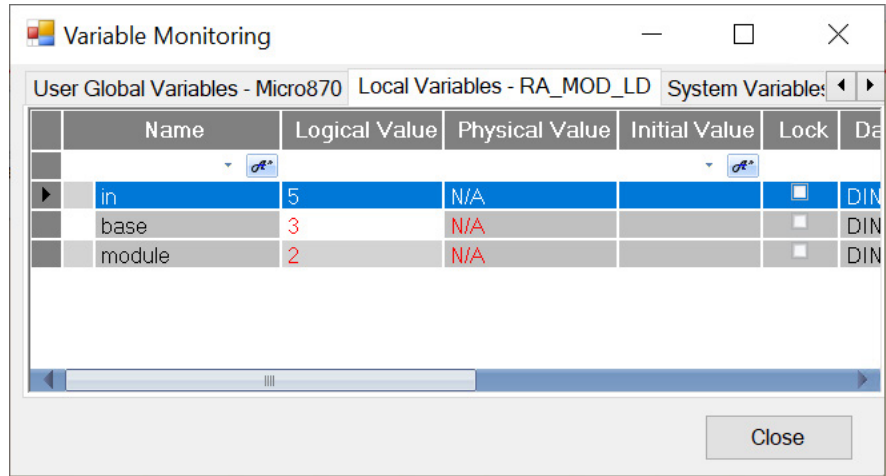

## MOV (move)

Assigns the input (i1) value to the output (o1).

Languages supported: Function Block Diagram, Ladder Diagram, Structured Text.

For Structured Text programs, use the Equal (=) operator instead of MOV.

This instruction applies to the Micro810, Micro820, Micro830, Micro850, Micro870 controllers and Micro800 Simulator.



Use this table to help determine the parameter values for this instruction.

Parameter	Parameter Type	Data Type	Description
EN	Input	BOOL	Instruction enable. TRUE - execute the direct link to an output computation. FALSE - there is no computation. Applies only to Ladder Diagram programs.

i1	Input	BOOL DINT REAL TIME STRING SINT USINT INT UINT UDINT LINT ULINT DATE LREAL BYTE WORD DWORD LWORD	Input and output must use the same data type.
o1	Output	BOOL DINT REAL TIME STRING SINT USINT INT UINT UDINT LINT ULINT DATE LREAL BYTE WORD DWORD LWORD	Input and output must use the same data type.
ENO	Output	BOOL	Enable output. Applies only to Ladder Diagram programs.

### Structured Text example

(\* ST equivalence: \*)

```
ao23 := ai10;
```

## Multiplication

Multiplies two or more Integer or Real values.

Languages supported: Function Block Diagram, Ladder Diagram, Structured Text.

This instruction applies to the Micro810, Micro820, Micro830, Micro850, Micro870 controllers and Micro800 Simulator.

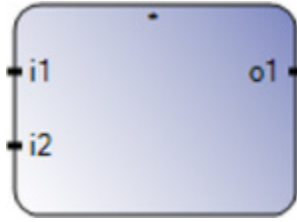

Use this table to help determine the parameter values for this instruction.

Parameter	Parameter Type	Data Type	Description
EN	Input	BOOL	Instruction enable. TRUE - execute current multiplication computation. FALSE - there is no computation. Applies only to Ladder Diagram programs.
i1	Input	SINT USINT BYTE INT UINT WORD DINT UDINT DWORD LINT ULINT LWORD REAL LREAL	Factor in Integer or Real data type. All inputs must be the same data type.
i2	Input	SINT USINT BYTE INT UINT WORD DINT UDINT DWORD LINT LINT LWORD REAL LREAL	Factor in Integer or Real data type. All inputs must be the same data type.

o1	Output	SINT USINT BYTE INT UINT WORD DINT UDINT DWORD LINT ULINT LWORD REAL LREAL	Product of the inputs in Integer or Real data type. Input and output must use the same data type.
ENO	Output	BOOL	Enable out. Applies only to Ladder Diagram programs.

### Multiplication Structured Text example

(\* ST equivalence \*)

```
ao10 := ai101 * ai102;
ao5 := (ai51 * ai52) * ai53;
```

### Neg (negation)

Converts a value to a negated value.

Languages supported: Function Block Diagram, Ladder Diagram, Structured Text.

This instruction applies to the Micro810, Micro820, Micro830, Micro850, Micro870 controllers and Micro800 Simulator.

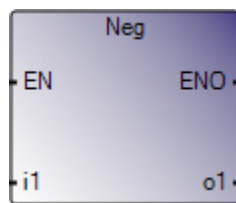

Use this table to help determine the parameter values for this instruction.

Parameter	Parameter Type	Data Type	Description
EN	Input	BOOL	Instruction enable. TRUE - execute current convert to negative computation. FALSE - there is no computation. Applies only to Ladder Diagram programs.
i1	Input	SINT INT DINT LINT REAL LREAL	Input and output must be the same data type.



o1	Output	SINT INT DINT LINT REAL LREAL	Input and output must be the same data type.
ENO	Output	BOOL	Enable output. Applies only to Ladder Diagram programs.

### Neg Structured Text example

(\* ST equivalence: \*)

```
ao23 := - (ai10);
ro100 := - (ri1 + ri2);
```

### POW (raise power)

When the first argument is 'base' and the second argument is 'exponent', calculate the Real result of (base exponent).

Languages supported: Function Block Diagram, Ladder Diagram, Structured Text.

This instruction applies to the Micro810, Micro820, Micro830, Micro850, Micro870 controllers and Micro800 Simulator.



Use this table to help determine the parameter values for this instruction.

Parameter	Parameter Type	Data Type	Description
EN	Input	BOOL	Instruction enable. TRUE - execute current exponent computation. FALSE - there is no computation. Applies to Ladder Diagram programs.
IN	Input	REAL	Real number to be raised.
EXP	Input	REAL	Power (exponent).
POW	Output	REAL	(IN EXP) 1.0 if IN is not 0.0 and EXP is 0.0 0.0 if IN is 0.0 and EXP is negative 0.0 if both IN and EXP are 0.0 0.0 if IN is negative and EXP does not correspond to an integer.
ENO	Output	BOOL	Enable output. Applies to Ladder Diagram programs.

### POW Function Block Diagram example

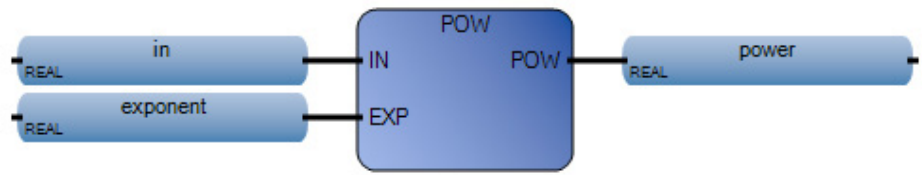

### POW Ladder Diagram example

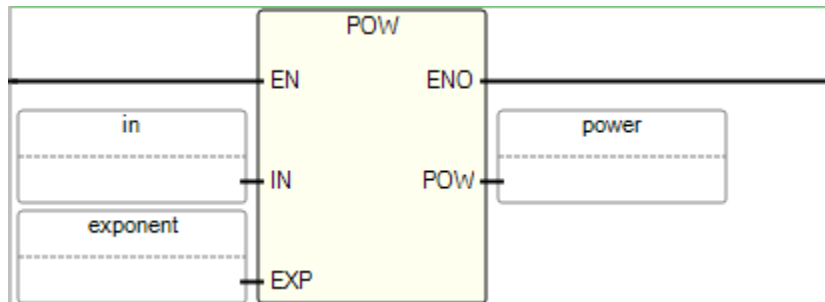

### POW Structured Text example

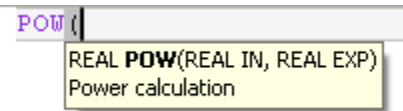

```

1  in := 2.0;
2  exponent := 3.0;
3  power := POW(in, exponent);

```

(\* ST Equivalence: \*)

result := POW (xval, power);

## Results

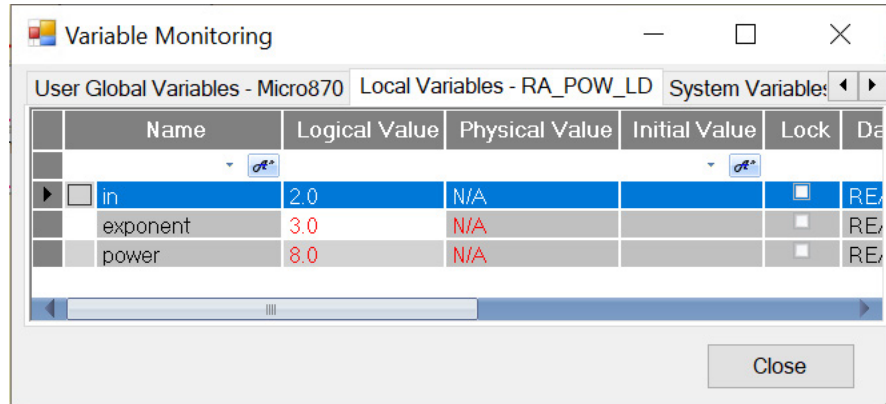

## RAND (random value)

Calculates random integer values from a defined range.

Languages supported: Function Block Diagram, Ladder Diagram, Structured Text.

This instruction applies to the Micro810, Micro820, Micro830, Micro850, Micro870 controllers and Micro800 Simulator.

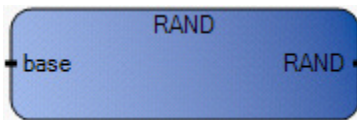

Use this table to help determine the parameter values for this instruction.

Parameter	Parameter Type	Data Type	Description
EN	Input	BOOL	Instruction enable. TRUE - execute the random integer value computation. FALSE - there is no computation. Applies to Ladder Diagram programs.
base	Input	DINT	Defines the supported set of numbers.
RAND	Output	DINT	Random value in set [0..base-1].
ENO	Output	BOOL	Enable output. Applies to Ladder Diagram programs.

## RAND Function Block Diagram example

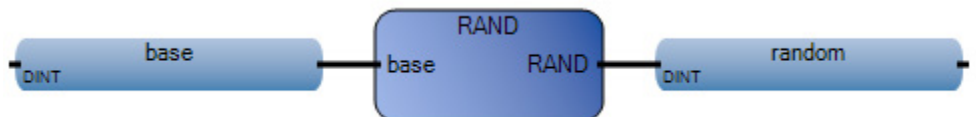

### RAND Ladder Diagram example

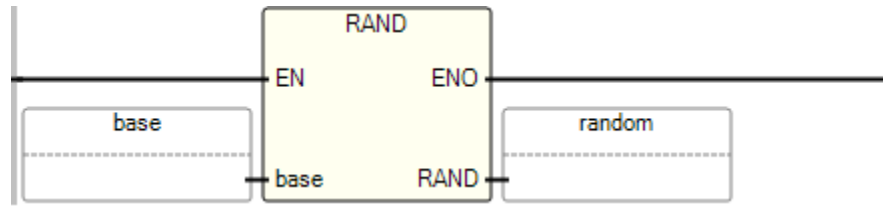

### RAND Structured Text example

```
RAND (
  DINT RAND(DINT base)
  Random value
```

```
1 base := 10;
2 random := RAND (base);
```

(\* ST Equivalence: \*)

selected := MUX4 ( RAND (4), 1, 4, 8, 16 );

(\*

random selection of 1 of 4 pre-defined values

the value issued of RAND call is in set [0..3],

so 'selected' issued from MUX4, will get 'randomly' the value

1 if 0 is issued from RAND,

or 4 if 1 is issued from RAND,

or 8 if 2 is issued from RAND,

or 16 if 3 is issued from RAND,

\*)

## Results

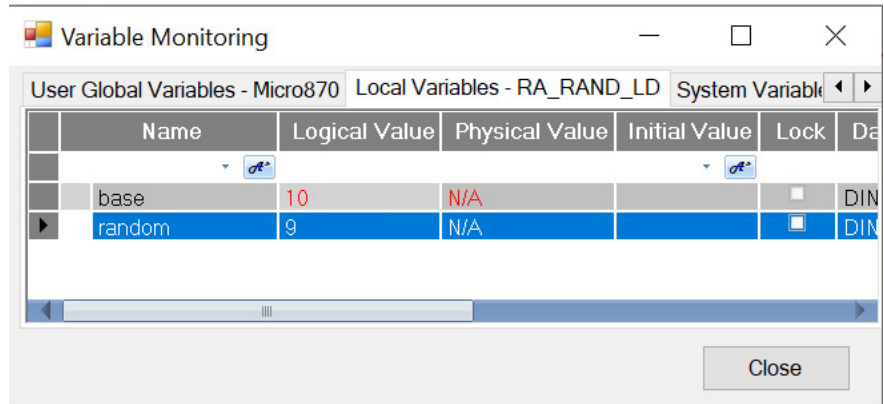

## SIN (sine)

Calculates the sine of a Real value.

Languages supported: Function Block Diagram, Ladder Diagram, Structured Text.

This instruction applies to the Micro810, Micro820, Micro830, Micro850, Micro870 controllers and Micro800 Simulator.

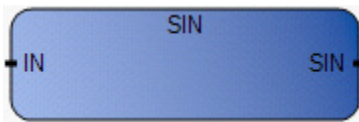

Use this table to help determine the parameter values for this instruction.

Parameter	Parameter Type	Data Type	Description
EN	Input	BOOL	Instruction enable. TRUE - execute current sine computation. FALSE - there is no computation. Applies to Ladder Diagram programs.
IN	Input	REAL	Any Real value.
SIN	Output	REAL	Sine of the input value (in set [-1.0 .. +1.0]).
ENO	Output	BOOL	Enable output. Applies to Ladder Diagram programs.

### SIN Function Block Diagram example



### SIN Ladder Diagram example

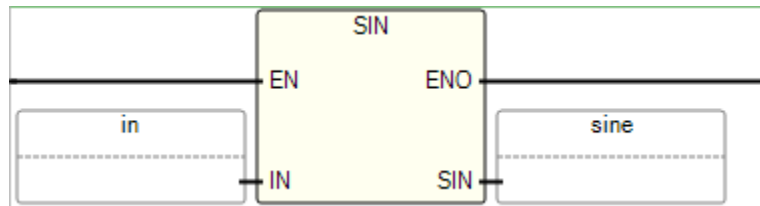

### SIN Structured Text example

```
SIN (
  REAL SIN(REAL IN)
  Sine
```

```
1 in := 0.5;
2 sine := SIN(in);
```

(\* ST Equivalence: \*)

sine := SIN (angle);

result := ASIN (sine); (\* result is equal to angle \*)

### Results

Name	Logical Value	Physical Value	Initial Value	Lo
in	0.5	N/A		
sine	0.4794255	N/A		

### SIN\_LREAL (sine Long Real)

Calculates the sine of a Long Real value.

Languages supported: Function Block Diagram, Ladder Diagram, Structured Text.

This instruction applies to the Micro810, Micro820, Micro830, Micro850, Micro870 controllers and Micro800 Simulator.

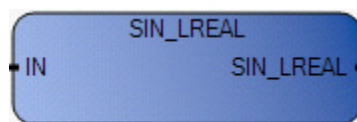

Use this table to help determine the parameter values for this instruction.

Parameter	Parameter Type	Data Type	Description
EN	Input	BOOL	Instruction enable. TRUE - execute current computation. FALSE - there is no computation. Applies to Ladder Diagram programs.
IN	Input	LREAL	Any Long Real value.
SIN_LREAL	Output	LREAL	Sine of the input value (in set [-1.0 .. +1.0]).
ENO	Output	BOOL	Enable output. Applies to Ladder Diagram programs.

### SIN\_LREAL Function Block Diagram example

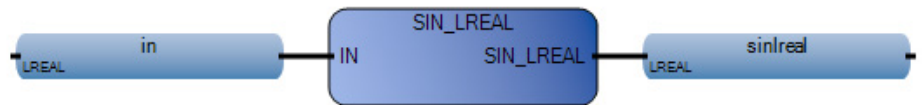

### SIN\_LREAL Ladder Diagram example

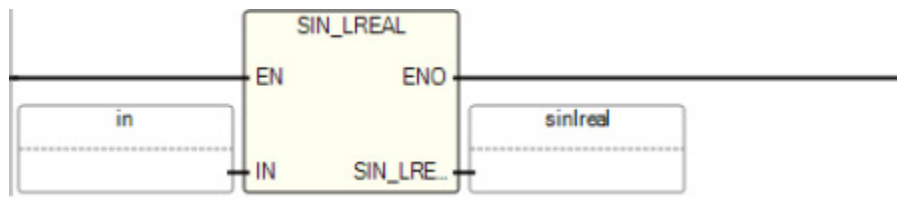

### SIN\_LREAL Structured Text example

```
SIN_LREAL {
  LREAL SIN_LREAL(LREAL IN)
  Perform 64-bit real sine calculation.
```

```
1 | in := 0.5;
2 | sinreal := SIN_LREAL(in);
```

(\* ST Equivalence: \*)

```
TESTOUTPUT1 := SIN_LREAL(TESTINPUT1);
```

## Results

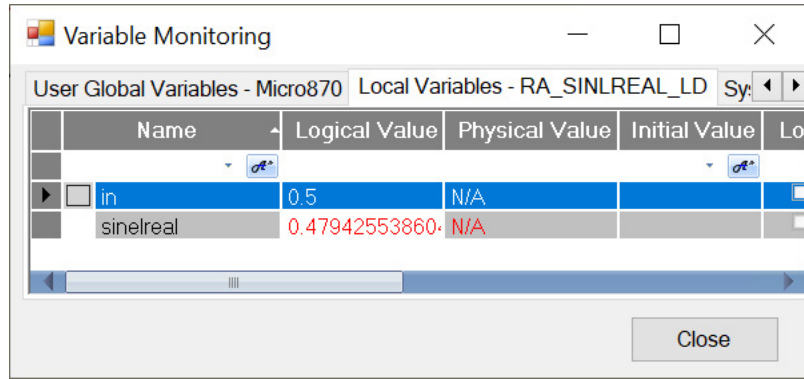

## SQRT (square root)

Calculates the square root of a Real value.

Languages supported: Function Block Diagram, Ladder Diagram, Structured Text.

This instruction applies to the Micro810, Micro820, Micro830, Micro850, Micro870 controllers and Micro800 Simulator.



Use this table to help determine the parameter values for this instruction.

Parameter	Parameter Type	Data Type	Description
EN	Input	BOOL	Instruction enable. TRUE - execute current square root computation. FALSE - there is no computation. Applies to Ladder Diagram programs.
IN	Input	REAL	Must be greater than or equal to zero.
SQRT	Output	REAL	Square root of the input value. The returned result is 0 for a negative IN value.
ENO	Output	BOOL	Enable output. Applies to Ladder Diagram programs.

## SQRT Function Block Diagram example

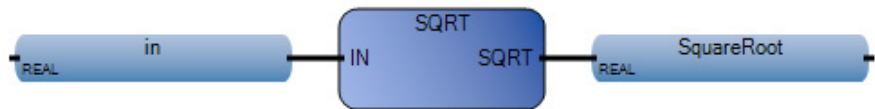



### SQRT Ladder diagram example

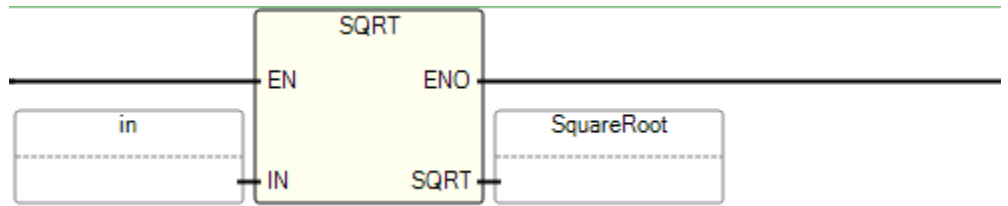

### SQRT Structured Text example

```

1 | in := 16.0;
2 | SquareRoot := SQRT(in);

```

SQRT (

REAL SQRT (REAL IN)  
Square root

(\* ST Equivalence: \*)

xpos := ABS (xval);

xroot := SQRT (xpos);

### Results

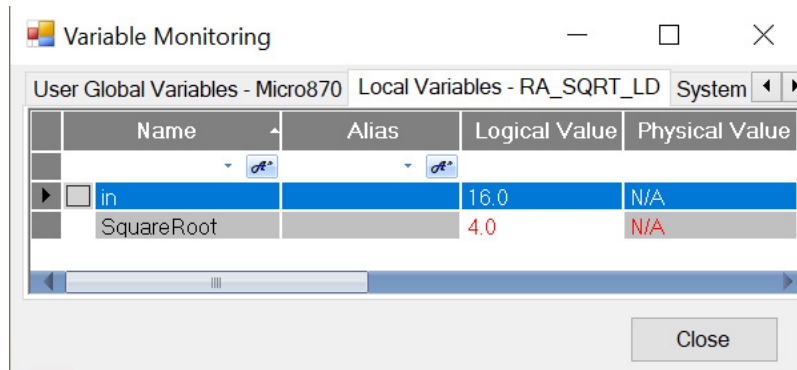

## Subtraction

Subtracts one Integer, Real, or Time value from another Integer, Real or Time value.

Languages supported: Function Block Diagram, Ladder Diagram, Structured Text.

This instruction applies to the Micro810, Micro820, Micro830, Micro850, Micro870 controllers and Micro800 Simulator.

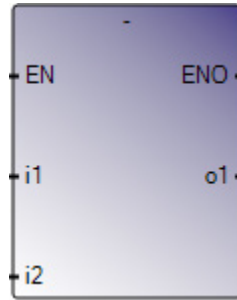

Use this table to help determine the parameter values for this instruction.

Parameter	Parameter Type	Data Type	Description
EN	Input	BOOL	Instruction enable. TRUE - execute current addition computation. FALSE - there is no computation. Applies only to Ladder Diagram programs.
i1	Input	SINT USINT BYTE INT UINT WORD DINT UDINT DWORD LINT ULINT LWORD REAL LREAL TIME	Minuend in any Integer, Real or Time data type. All inputs must be the same data type.
i2	Input	SINT USINT BYTE INT UINT WORD DINT UDINT DWORD LINT ULINT LWORD REAL LREAL TIME	Subtrahend in any Integer, Real or Time data type. All inputs must be the same data type.

o1	Output	SINT USINT BYTE INT UINT WORD DINT UDINT DWORD LINT ULINT LWORD REAL LREAL TIME	Difference of the minuend and the subtrahend in any Integer, Real or Time data type. Output must be the same data type as inputs.
ENO	Output	BOOL	Enable output. Applies only to Ladder Diagram programs.

### Subtraction Structured Text example

(\* ST equivalence: \*)

```
ao10 := ai101 - ai102;
ao5 := (ai51 - 1) - ai53;
```

## TAN (tangent)

Calculates the tangent of a Real value.

Languages supported: Function Block Diagram, Ladder Diagram, Structured Text.

This instruction applies to the Micro810, Micro820, Micro830, Micro850, Micro870 controllers and Micro800 Simulator.

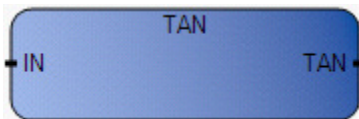

Use this table to help determine the parameter values for this instruction.

Parameter	Parameter Type	Data Type	Description
EN	Input	BOOL	Instruction enable. TRUE - perform current tangent computation. FALSE - there is no computation. Applies to Ladder Diagram programs.
IN	Input	REAL	Cannot be equal to PI/2 modulo PI.
TAN	Output	REAL	Tangent of the input value = 1E+38 for invalid input.
ENO	Output	BOOL	Enable output. Applies to Ladder Diagram programs.

### TAN Function Block Diagram example



### TAN Ladder Diagram example

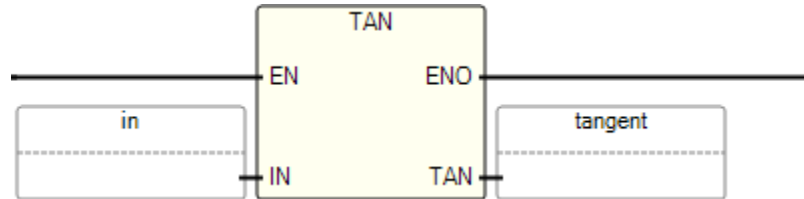

### TAN Structured Text example

```
TAN (
REAL TAN(REAL IN)
Tangent
```

```
1 in := 0.5;
2 tangent := TAN(in);
```

(\* ST Equivalence: \*)

tangent := TAN (angle);

result := ATAN (tangent); (\* result is equal to angle\*)

### Results

Name	Logical Value	Physical Value	Initial Value	Lo
in	0.5	N/A		
tangent	0.5463025	N/A		

### TAN\_LREAL (tangent Long Real)

Calculates the tangent of a Long Real value.

Languages supported: Function Block Diagram, Ladder Diagram, Structured Text.

This instruction applies to the Micro810, Micro820, Micro830, Micro850, Micro870 controllers and Micro800 Simulator.

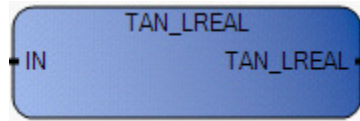

Use this table to help determine the parameter values for this instruction.

Parameter	Parameter Type	Data Type	Description
EN	Input	BOOL	Instruction enable. TRUE - perform current computation. FALSE - there is no computation. Applies to Ladder Diagram programs.
IN	Input	LREAL	Cannot be equal to PI/2 modulo PI.
TAN_LREAL	Output	LREAL	Tangent of the input value = 1E+38 for invalid input.
ENO	Output	BOOL	Enable output. Applies to Ladder Diagram programs.

### TAN\_LREAL Function Block Diagram example

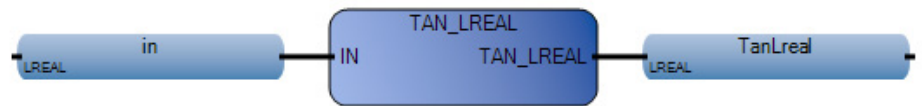

### TAN\_LREAL Ladder Diagram example

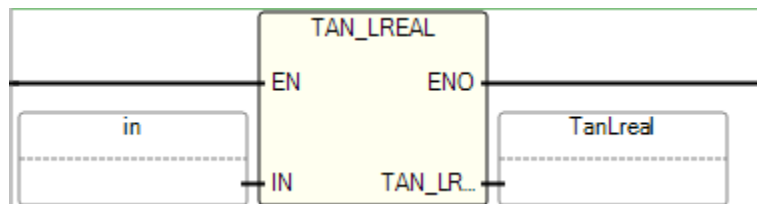

### TAN\_LREAL Structured Text example

```
TAN_LREAL (
  LREAL TAN_LREAL(LREAL IN)
  Perform 64-bit real tangent calculation.
```

```
1 in := 0.5;
2 TanLreal := TAN_LREAL(in);
```

(\* ST Equivalence: \*)

tangent := TAN\_LREAL (angle);

result := ATAN\_LREAL (tangent); (\* result is equal to angle\*)

## Results

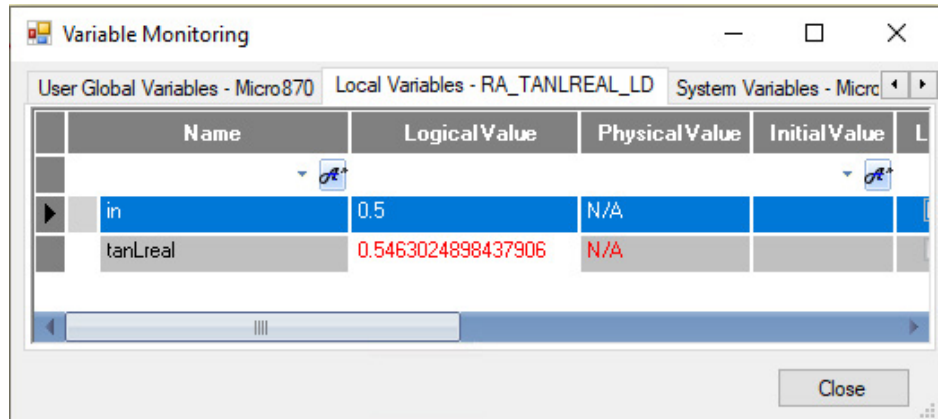

## TRUNC (truncate)

Truncates Real values, leaving just the Integer.

Languages supported: Function Block Diagram, Ladder Diagram, Structured Text.

This instruction applies to the Micro810, Micro820, Micro830, Micro850, Micro870 controllers and Micro800 Simulator.



Use this table to help determine the parameter values for this instruction.

Parameter	Parameter Type	Data Type	Description
EN	Input	BOOL	Instruction enable. TRUE - perform the truncation of Real value computation. FALSE - there is no computation. Applies to Ladder Diagram programs.
IN	Input	REAL	Any Real value.
TRUNC	Output	REAL	If IN>0, biggest integer less or equal to the input. If IN<0, least integer greater or equal to the input.
ENO	Output	BOOL	Enable output. Applies to Ladder Diagram programs.

### TRUNC Function Block Diagram example

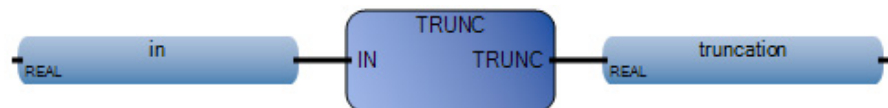

### TRUNC Ladder Diagram example

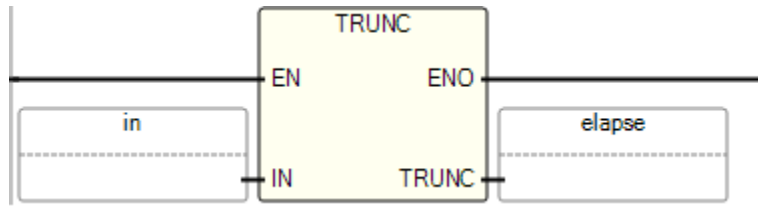

### TRUNC Structured Text example

```
TRUNC (
  REAL TRUNC(REAL IN)
  Truncate decimal part
```

```
1 in := 1.7;
2 truncation := TRUNC(in);
```

(\* ST Equivalence: \*)

result := TRUNC (+2.67) + TRUNC (-2.0891);

(\* means: result := 2.0 + (-2.0) := 0.0; \*)

### Results

Name	Logical Value	Physical Value	Initial Value	Lock
in	1.7	N/A		<input type="checkbox"/>
elapsed	1.0	N/A		<input type="checkbox"/>





## ASCII serial port instructions

Use the ASCII serial port instructions to use or alter the communication channel for receiving or transmitting data.

Function block	Description
<a href="#">ABL</a> on <a href="#">page 105</a>	Counts the number of characters in the buffer up to and including end of line character.
<a href="#">ACB</a> on <a href="#">page 111</a>	Counts the total number of characters in the buffer.
<a href="#">ACL</a> on <a href="#">page 107</a>	Clears the receive and transmit buffers.
<a href="#">AHL</a> on <a href="#">page 109</a>	Sets or resets modem handshake lines.
<a href="#">ARD</a> on <a href="#">page 113</a>	Reads characters from the input buffer and places them into a string.
<a href="#">ARL</a> on <a href="#">page 115</a>	Reads one line of characters from the input buffer and places them into a string.
<a href="#">AWA</a> on <a href="#">page 117</a>	Writes a string with two appended (user-configured) characters to an external device.
<a href="#">AWT</a> on <a href="#">page 119</a>	Writes characters from a source string to an external device.

### ABL (ASCII test for buffer line)

Counts the number of ASCII characters in the input buffer up to and including the end-of-line termination character.

Languages supported: Function Block Diagram, Ladder Diagram, Structured Text.

This instruction applies to the Micro820, Micro830, Micro850, and Micro870 controllers.

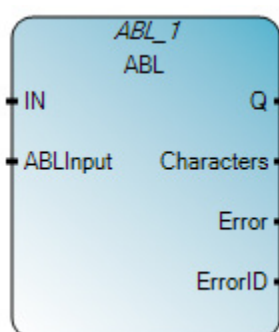

Use this table to help determine the parameter values for this instruction.

Parameter	Parameter Type	Data Type	Description
IN	Input	BOOL	Rung input state. TRUE - When Rising Edge is detected, start the function block with the precondition that the last operation is complete. FALSE - The instruction block is idle.

ABLInput	Input	ABLACB	The channel to be operated. Use the <a href="#">ABLACB data type</a> on <a href="#">page 122</a> to define the Channel, TriggerType, and Cancel parameters for ABLInput.
Q	Output	BOOL	Indicates when the character count is ongoing or complete. The outputs update asynchronously from the program scan. Output Q cannot be used to re-trigger the instruction since IN is edge triggered. TRUE - The function block is complete. FALSE - The function block is not complete.
Characters	Output	UINT	The number of characters in the buffer. The buffer limit is 82 characters.
Error	Output	BOOL	Indicates the existence of an error condition. TRUE - An error is detected. FALSE - No error.
ErrorID	Output	UINT	A unique numeric that identifies the error. The errors for this instruction are defined in ABL error codes.

### ABL error codes

Use this table to determine the ABL error codes and descriptions.

Error code	Error description
03	Transmission cannot be completed because the Clear-to-Send signal was lost.
06	Illegal parameter was detected.
07	Cannot complete ASCII send or receive because channel configuration has been shut down using the channel configuration dialog box.
08	Cannot complete ASCII Write due to an ASCII transmission already in progress.
09	ASCII communication requested is not supported by current channel configuration.
10	The Cancel was set, stopping instruction execution. No action required.
11	The requested length for the string is either invalid, a negative number, greater than 82, or 0. Applies to ARD and ARL function blocks.
13	The requested (.LEN) in the control block is a negative number or a value greater than the string size stored with the source string. Applies to AWA and AWT function blocks.
14	The ACL function block was cancelled.
16	Serial port is not supporting RTS or CTS control lines.

### ABL Function Block Diagram example

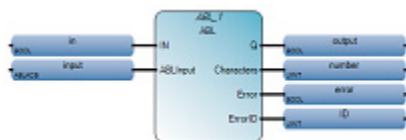

### ABL Ladder Diagram example

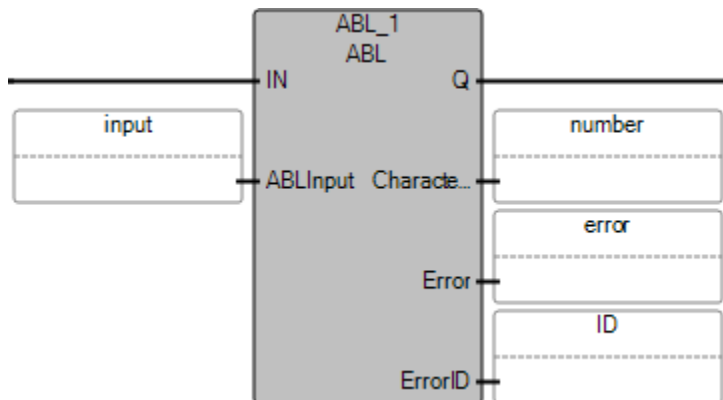

### ABL Structured Text example

```

ABL_1(
void ABL_1(BOOL IN, ABLACB ABLInput)
Type : ABL, Specify number of characters in buffer (including end of line).

1 | ABL_1(in, input);
2 | output := ABL_1.Q;
3 | number := ABL_1.Characters;
4 | error := ABL_1.Error;
5 | ID := ABL_1.ErrorID;

```

### ACL (ASCII clear buffer)

Clears the receive and transmit buffers, and removes instructions from the ASCII queue.

Languages supported: Function Block Diagram, Ladder Diagram, Structured Text.

This instruction applies to the Micro820, Micro830, Micro850, and Micro870 controllers.

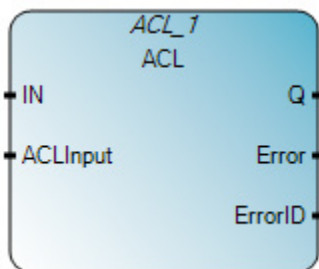

Use this table to help determine the parameter values for this instruction.

Parameter	Parameter Type	Data Type	Description
IN	Input	BOOL	Rung input state. TRUE - When Rising Edge is detected, start the function block with the precondition that the last operation is complete. FALSE - The instruction block is idle.

ACLInput	Input	ACLI	The channel to be operated, and the state of the transmit and receive buffers. For RXBuffer, clears the receive buffer and removes the receive ASCII function blocks (ARL and ARD) from the ASCII queue. For TXBuffer, clears the transmit buffer and removes the transmit ASCII function blocks (AWA and AWT) from the ASCII queue. Use the <a href="#">ACLI data type</a> on <a href="#">page 122</a> to define the Channel, RXBuffer, and TXBuffer parameters for ACLInput.
Q	Output	BOOL	Indicates when the ASCII queue clearing process is ongoing or complete. TRUE - The function block is complete. FALSE - The function block is not complete.
Error	Output	BOOL	Indicates the existence of an error condition. TRUE - An error is detected. FALSE - No error.
ErrorID	Output	UINT	A unique numeric that identifies the error. The errors for this instruction are defined in ABL error codes.

### ABL error codes

Use this table to determine the ABL error codes and descriptions.

Error code	Error description
03	Transmission cannot be completed because the Clear-to-Send signal was lost.
06	Illegal parameter was detected.
07	Cannot complete ASCII send or receive because channel configuration has been shut down using the channel configuration dialog box.
08	Cannot complete ASCII Write due to an ASCII transmission already in progress.
09	ASCII communication requested is not supported by current channel configuration.
10	The Cancel was set, stopping instruction execution. No action required.
11	The requested length for the string is either invalid, a negative number, greater than 82, or 0. Applies to ARD and ARL function blocks.
13	The requested (.LEN) in the control block is a negative number or a value greater than the string size stored with the source string. Applies to AWA and AWT function blocks.
14	The ACL function block was cancelled.
16	Serial port is not supporting RTS or CTS control lines.

### ACL Function Block Diagram example



### ACL Ladder Diagram example

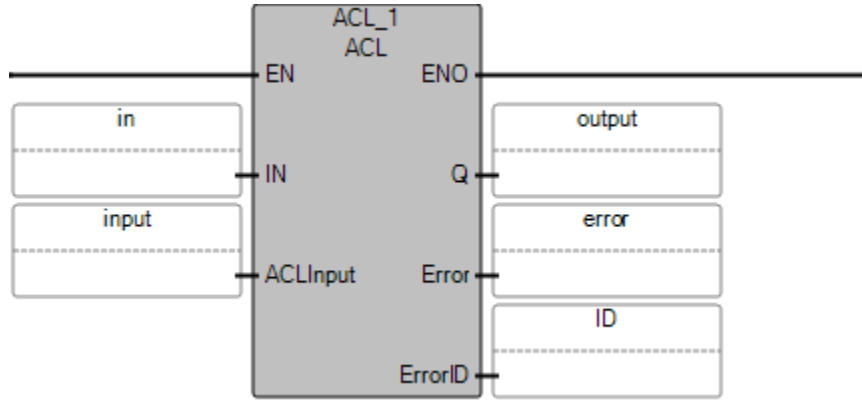

### ACL Structured Text example

```

ACL_1 (
void ACL_1(BOOL IN, ACLI ACLInput)
Type : ACL, Clear the receive and/or transmit buffers.

1  ACL_1(in, input);
2  output := ACL_1.Q;
3  error := ACL_1.Error;
4  ID := ACL_1.ErrorID;

```

**AHL (ASCII handshake lines)** Sets or resets the RS-232 Request to Send (RTS) handshake control lines for a modem.

Languages supported: Function Block Diagram, Ladder Diagram, Structured Text.

This instruction applies to the Micro820, Micro830, Micro850, and Micro870 controllers.

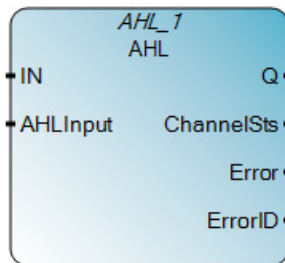

Use this table to help determine the parameter values for this instruction.

Parameter	Parameter Type	Data Type	Description
IN	Input	BOOL	Rung input state. TRUE - When Rising Edge is detected, start the instruction block with the precondition that the last operation is complete. FALSE - The instruction block is idle.
AHLInput	Input	AHLI	The channel to be operated, and the set or reset of the RTS control line for the modem. Use the <a href="#">AHLI data type</a> on <a href="#">page 123</a> to define the Channel, SetRts, ClrRts, and Cancel parameters for AHLInput.

Q	Output	BOOL	Indicates when the set or reset is complete. Outputs of this instruction are updated asynchronously from the program scan. Output Q cannot be used to re-trigger the instruction since IN is edge triggered. TRUE - The function block is complete. FALSE - The function block is not complete.
ChannelSts	Output	WORD	Displays the current status (0000 to 001F) of the handshake lines for the specified channel.
Error	Output	BOOL	Indicates the existence of an error condition. TRUE - An error is detected. FALSE - No error.
ErrorID	Output	UINT	A unique numeric that identifies the error. The errors for this instruction are defined in ABL error codes.

### ABL error codes

Use this table to determine the ABL error codes and descriptions.

Error code	Error description
03	Transmission cannot be completed because the Clear-to-Send signal was lost.
06	Illegal parameter was detected.
07	Cannot complete ASCII send or receive because channel configuration has been shut down using the channel configuration dialog box.
08	Cannot complete ASCII Write due to an ASCII transmission already in progress.
09	ASCII communication requested is not supported by current channel configuration.
10	The Cancel was set, stopping instruction execution. No action required.
11	The requested length for the string is either invalid, a negative number, greater than 82, or 0. Applies to ARD and ARL function blocks.
13	The requested (.LEN) in the control block is a negative number or a value greater than the string size stored with the source string. Applies to AWA and AWT function blocks.
14	The ACL function block was cancelled.
16	Serial port is not supporting RTS or CTS control lines.

### AHL Function Block Diagram example

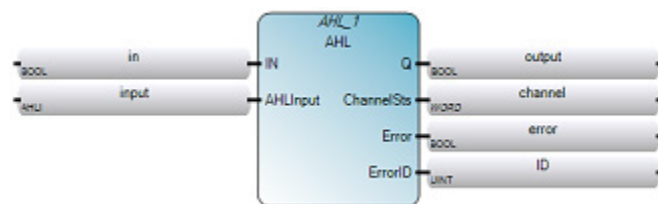

### AHL Ladder Diagram example

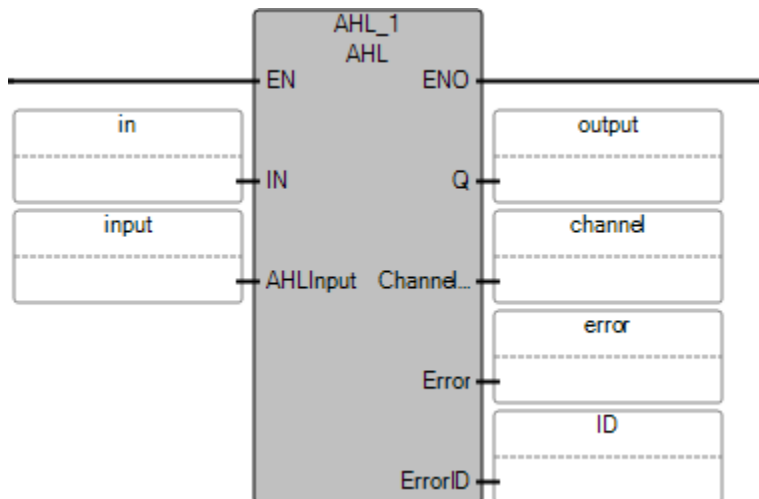

### AHL Structured Text example

```

AHL_1(
void AHL_1(BOOL IN, AHLI AHLInput)
Type : AHL, Set or reset modem handshake lines.

1 | AHL_1(in, input);
2 | output := AHL_1.Q;
3 | channel := AHL_1.ChannelSts;
4 | error := AHL_1.Error;
5 | ID := AHL_1.ErrorID;

```

### ACB (ASCII characters in buffer)

Counts the total number of ASCII characters in the buffer including end of line.

Languages supported: Function Block Diagram, Ladder Diagram, Structured Text.

This instruction applies to the Micro820, Micro830, Micro850, and Micro870 controllers.

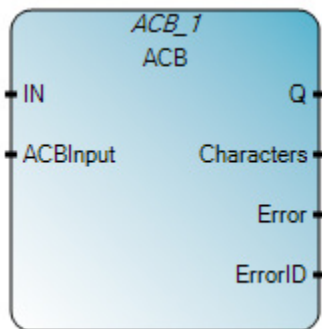

Use this table to help determine the parameter values for this instruction.

Parameter	Parameter Type	Data Type	Description
-----------	----------------	-----------	-------------

IN	Input	BOOL	Rung input state. TRUE - When Rising Edge is detected, start the instruction block with the precondition that the last operation is complete. FALSE - The instruction block is idle.
ACBInput	Input	<a href="#">ABLACB</a> on <a href="#">page 122</a>	The channel to be operated. Use the ABLACB data type to define the Channel, TriggerType, and Cancel parameters for ACBInput.
Q	Output	BOOL	Indicates whether the character count is ongoing or complete. Outputs of this function block are updated asynchronously from the program scan. Output Q cannot be used to re-trigger the instruction since IN is edge triggered. TRUE - The counting is complete. FALSE - The counting is ongoing.
Characters	Output	UINT	The number of characters in the buffer.
Error	Output	BOOL	Indicates the existence of an error condition. FALSE - No error. TRUE - An error is detected.
ErrorID	Output	UINT	A unique numeric that identifies the error. The errors for this instruction are defined in ABL error codes.

### ACB error codes

Use this table to determine the ABL error codes and descriptions.

Error code	Error description
03	Transmission cannot be completed because the Clear-to-Send signal was lost.
06	Illegal parameter was detected.
07	Cannot complete ASCII send or receive because channel configuration has been shut down using the channel configuration dialog box.
08	Cannot complete ASCII Write due to an ASCII transmission already in progress.
09	ASCII communication requested is not supported by current channel configuration.
10	The Cancel was set, stopping instruction execution. No action required.
11	The requested length for the string is either invalid, a negative number, greater than 82, or 0. Applies to ARD and ARL function blocks.
13	The requested (.LEN) in the control block is a negative number or a value greater than the string size stored with the source string. Applies to AWA and AWT function blocks.
14	The ACL function block was cancelled.
16	Serial port is not supporting RTS or CTS control lines.

### ACB Function Block Diagram example





## ACB Ladder Diagram example

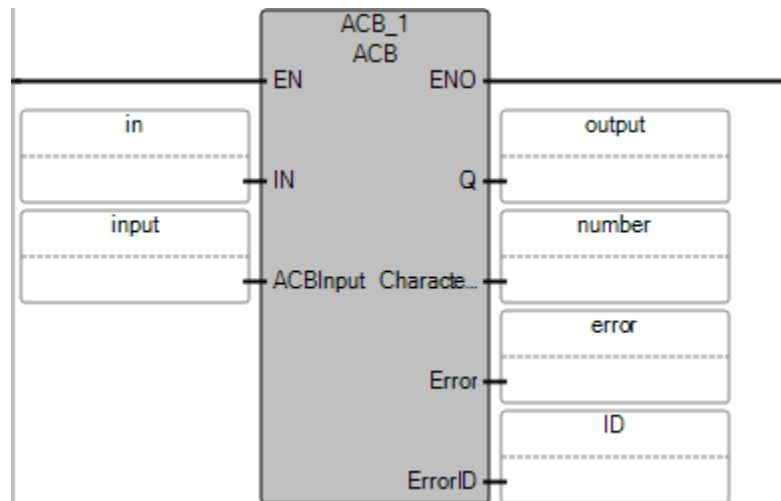

## ACB Structured Text example

```
ACB_1 (
void ACB_1(BOOL IN, ABLACB ACBInput)
Type : ACB, Determine total number of characters in buffer.
```

```
1 ACB_1(in, input);
2 output := ACB_1.Q;
3 number := ACB_1.Characters;
4 error := ACB_1.Error;
5 ID := ACB_1.ErrorID;
```

## ARD (ASCII read)

Reads ASCII characters from the input buffer and stores them into a string.

Operation details:

- The ARD instruction runs until all of the characters in the ASCII buffer are received. If another [ASCII instruction](#) on [page 105](#) is executed, it is queued until ARD is finished.
- To cancel the ARD instruction, execute an ACL instruction.
- To prevent the ARD instruction delaying the ASCII queue while it waits for the required number of characters, use the results of an ACB instruction to trigger the ARD instruction.
- Status of the instruction can be extracted from the control bit of the instruction instance (for example, ARD\_1.controlbit). This shows if the instruction is blocking the ASCII instruction queue waiting for more characters:
  - 7th bit = Instruction is enabled.
  - 6th bit = Instruction is in the queue.
  - 5th bit = Instruction is done.
  - 3rd bit = Instruction has an error.

Languages supported: Function Block Diagram, Ladder Diagram, Structured Text.

This instruction applies to the Micro820, Micro830, Micro850, and Micro870 controllers.

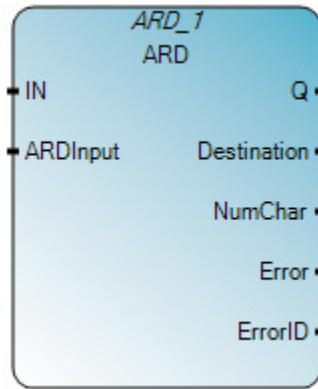

Use this table to help determine the parameter values for this instruction.

Parameter	Parameter Type	Data Type	Description
IN	Input	BOOL	Rung input state. TRUE - When Rising Edge is detected, start the instruction block with the precondition that the last operation is complete. FALSE - The instruction block is idle.
ARDInput	Input	<a href="#">ARDARL</a> on <a href="#">page 123</a>	Read characters from the buffer. The maximum is 82. Use the ARDARL data type to define the Channel, Length, and Cancel parameters for the ARDInput.
Q	Output	BOOL	Indicates when the buffer read is ongoing or complete. Outputs of this instruction are updated asynchronously from the program scan. Output Q cannot be used to re-trigger the instruction since IN is edge triggered. TRUE - The function block is complete. FALSE - The function block is not complete.
Destination	Output	ASCIILOCADDR	The string element where the characters are stored.
NumChar	Output	UINT	The number of characters.
Error	Output	BOOL	Indicates the existence of an error condition. TRUE - An error is detected. FALSE - No error.
ErrorID	Output	UINT	A unique numeric that identifies the error. The errors for this instruction are defined in ABL error codes.

### ABL error codes

Use this table to determine the ABL error codes and descriptions.

Error code	Error description
03	Transmission cannot be completed because the Clear-to-Send signal was lost.
06	Illegal parameter was detected.
07	Cannot complete ASCII send or receive because channel configuration has been shut down using the channel configuration dialog box.
08	Cannot complete ASCII Write due to an ASCII transmission already in progress.
09	ASCII communication requested is not supported by current channel configuration.
10	The Cancel was set, stopping instruction execution. No action required.
11	The requested length for the string is either invalid, a negative number, greater than 82, or 0. Applies to ARD and ARL function blocks.
13	The requested (.LEN) in the control block is a negative number or a value greater than the string size stored with the source string. Applies to AWA and AWT function blocks.

14	The ACL function block was cancelled.
16	Serial port is not supporting RTS or CTS control lines.

### ARD Function Block Diagram example

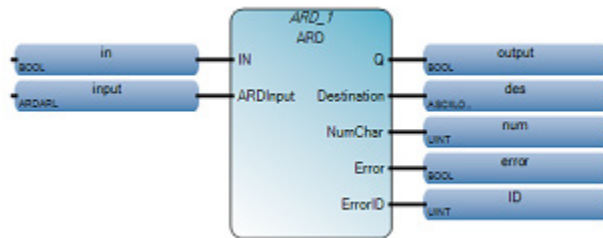

### ARD Ladder Diagram example

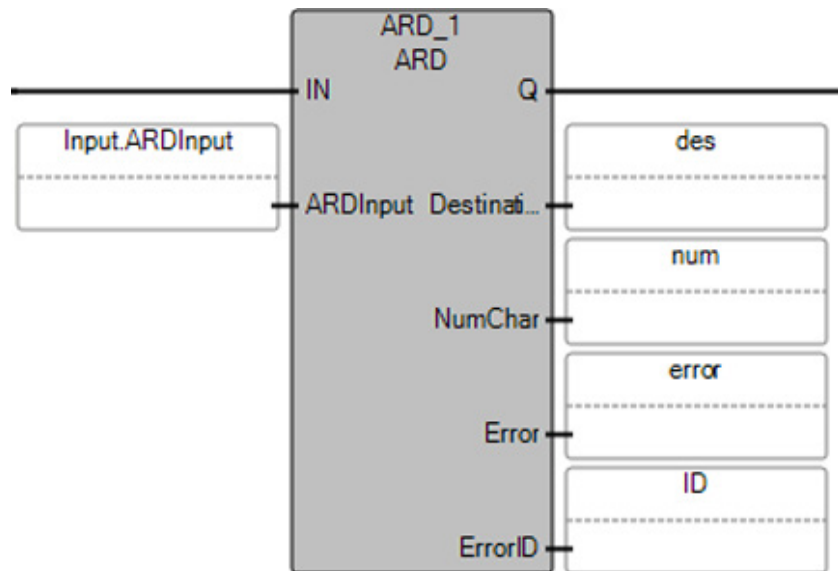

### ARD Structured Text example

```
ARD_1 {
    void ARD_1(BOOL IN, ARDARL ARDInput)
    Type : ARD, Read characters from the input buffer and place them into a string.
```

```
1 ARD_1(in, input);
2 output := ARD_1.Q;
3 des := ARD_1.Destination;
4 num := ARD_1.NumChar;
5 error := ARD_1.Error;
6 ID := ARD_1.ErrorID;
```

### ARL (ASCII read line)

Reads a line of [ASCII](#) on [page 105](#) characters from the buffer, up to and including the termination characters, and stores them in a string.

Languages supported: Function Block Diagram, Ladder Diagram, Structured Text.

This instruction applies to the Micro820, Micro830, Micro850, and Micro870 controllers.

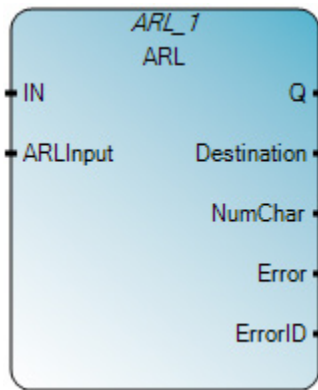

Use this table to help determine the parameter values for this instruction.

Parameter	Parameter Type	Data Type	Description
IN	Input	BOOL	Rung input state. TRUE - When Rising Edge is detected, start the instruction block with the precondition that the last operation is complete. FALSE - The instruction block is idle.
ARLInput	Input	<a href="#">ARDARL</a> on <a href="#">page 123</a>	Read a line of ASCII characters from the buffer. The maximum is 82. Use the ARDARL data type to define the Channel, Length, and Cancel parameters for the ARDLInput.
Q	Output	BOOL	Indicates when the read line from the input buffer is ongoing or complete. Outputs of this instruction are updated asynchronously from the program scan. Output Q cannot be used to re-trigger the instruction since IN is edge triggered. TRUE - The function block is complete. FALSE - The function block is not complete.
Destination	Output	ASCIILOCADDR	The string element where the characters are stored.
NumChar	Output	UINT	The number of characters in the line, including the termination character.
Error	Output	BOOL	Indicates the existence of an error condition. TRUE - An error is detected. FALSE - No error.
ErrorID	Output	UINT	A unique numeric that identifies the error. The errors for this instruction are defined in ABL error codes.

### ABL error codes

Use this table to determine the ABL error codes and descriptions.

Error code	Error description
03	Transmission cannot be completed because the Clear-to-Send signal was lost.
06	Illegal parameter was detected.
07	Cannot complete ASCII send or receive because channel configuration has been shut down using the channel configuration dialog box.
08	Cannot complete ASCII Write due to an ASCII transmission already in progress.
09	ASCII communication requested is not supported by current channel configuration.
10	The Cancel was set, stopping instruction execution. No action required.

11	The requested length for the string is either invalid, a negative number, greater than 82, or 0. Applies to ARD and ARL function blocks.
13	The requested (.LEN) in the control block is a negative number or a value greater than the string size stored with the source string. Applies to AWA and AWT function blocks.
14	The ACL function block was cancelled.
16	Serial port is not supporting RTS or CTS control lines.

### ARL Function Block Diagram example

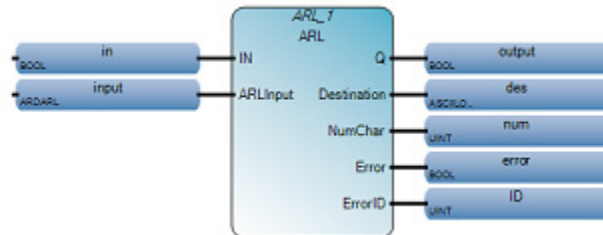

### ARL Ladder Diagram example

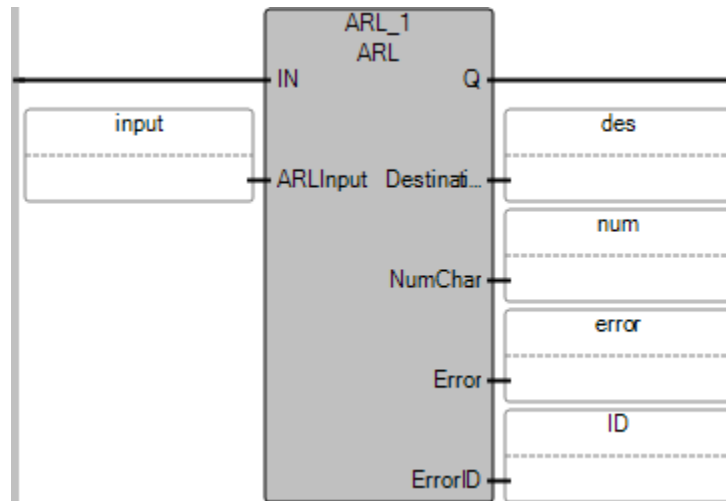

### ARL Structured Text example

```
ARL_1(
void ARL_1(BOOL IN, ARDARL ARLInput)
Type : ARL, Read line from the input buffer and place characters in a string.
```

```
1 ARL_1(in, input);
2 output := ARL_1.Q;
3 des := ARL_1.Destination;
4 num := ARL_1.NumChar;
5 error := ARL_1.Error;
6 ID := ARL_1.ErrorID;
```

### AWA (ASCII write append)

Writes a string with two appended (user-configured) characters to an external device.

Languages supported: Function Block Diagram, Ladder Diagram, Structured Text.

This instruction applies to the Micro820, Micro830, Micro850, and Micro870 controllers.

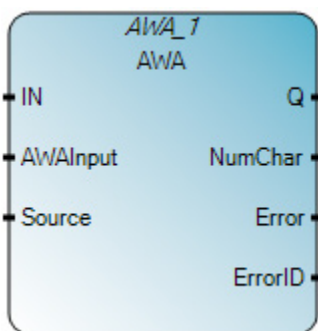

Use this table to help determine the parameter values for this instruction.

Parameter	Parameter Type	Data Type	Description
IN	Input	BOOL	Rung input state. TRUE - Rising Edge is detected, start the instruction block with the precondition that the last operation is complete. FALSE - The instruction block is idle.
AWAInput	Input	AWAAWT	The channel and number (Length) of the characters to write to the buffer. Maximum is 82. Use the <a href="#">AWAAWT data type</a> on <a href="#">page 123</a> to define Channel, Length, and Cancel parameters for AWAInput.
Source	Input	ASCIILOCADDR	The source string that was output as a character array by either the ARD or ARL instruction.
Q	Output	BOOL	Indicates when the write is ongoing or complete. Outputs of this instruction are updated asynchronously from the program scan. Output Q cannot be used to re-trigger the instruction since IN is edge triggered. TRUE - The function block is complete. FALSE - The function block is not complete.
NumChar	Output	UINT	The number of characters. NumChar may be less than the Length requested to be transmitted if the length of the Source String is shorter than the requested Length. Updates when the transmission is complete and Q is TRUE.
Error	Output	BOOL	Indicates the existence of an error condition. TRUE - An error is detected. FALSE - No error.
ErrorID	Output	UINT	A unique numeric that identifies the error. The errors for this instruction are defined in ABL error codes.

### ABL error codes

Use this table to determine the ABL error codes and descriptions.

Error code	Error description
03	Transmission cannot be completed because the Clear-to-Send signal was lost.
06	Illegal parameter was detected.
07	Cannot complete ASCII send or receive because channel configuration has been shut down using the channel configuration dialog box.
08	Cannot complete ASCII Write due to an ASCII transmission already in progress.
09	ASCII communication requested is not supported by current channel configuration.
10	The Cancel was set, stopping instruction execution. No action required.

11	The requested length for the string is either invalid, a negative number, greater than 82, or 0. Applies to ARD and ARL function blocks.
13	The requested (.LEN) in the control block is a negative number or a value greater than the string size stored with the source string. Applies to AWA and AWT function blocks.
14	The ACL function block was cancelled.
16	Serial port is not supporting RTS or CTS control lines.

### AWA Function Block Diagram example

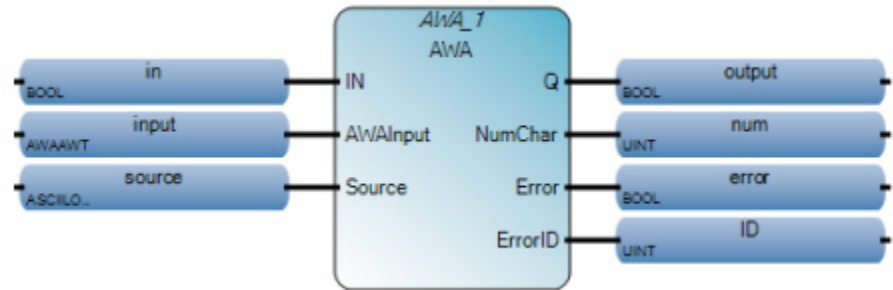

### AWA Ladder Diagram example

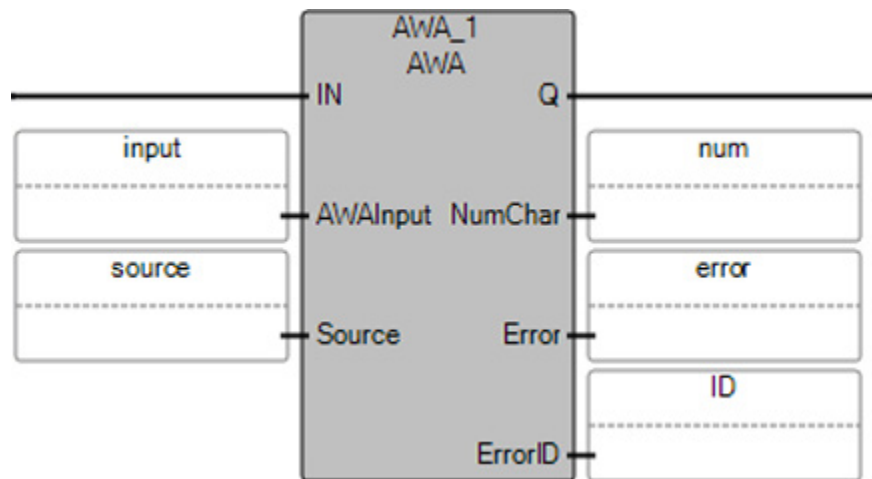

### AWA Structured Text example

```
AWA_1 (
void AWA_1(BOOL IN, AWAAWT AWAInput, ASCIILOCADDR Source)
Type : AWA, Write a string with characters appended to an external device.
```

```
1 AWA_1(in, input, source);
2 output := AWA_1.Q;
3 num := AWA_1.NumChar;
4 error := AWA_1.Error;
5 ID := AWA_1.ErrorID;
```

### AWT (ASCII write)

Writes ASCII characters from a source string to an external device.

Languages supported: Function Block Diagram, Ladder Diagram, Structured

Text.

This instruction applies to the Micro820, Micro830, Micro850, and Micro870 controllers.

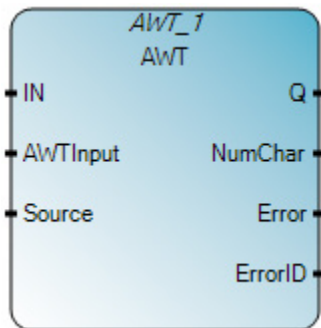

Use this table to help determine the parameter values for this instruction.

Parameter	Parameter Type	Data Type	Description
IN	Input	BOOL	Rung input state. TRUE - When Rising Edge is detected, start the instruction block with the precondition that the last operation is complete. FALSE - The instruction block is idle.
AWTInput	Input	AWAAWT	The channel and number (Length) of the characters to write to the buffer. Maximum is 82. Use the <a href="#">AWAAWT data type</a> on <a href="#">page 123</a> to define Channel, Length, and Cancel parameters for AWTInput.
Source	Input	ASCIILOCADDR	The source string that was output as a character array by either the ARD or ARL instruction.
Q	Output	BOOL	Indicates when the write is ongoing or complete. Outputs of this instruction are updated asynchronously from the program scan. Output Q cannot be used to re-trigger the instruction since IN is edge triggered. TRUE - The function block is complete. FALSE - The function block is not complete.
NumChar	Output	UINT	The number of characters. NumChar may be less than the Length requested to be transmitted if the length of the Source String is shorter than the requested Length. Updates when the transmission is complete and Q is TRUE.
Error	Output	BOOL	Indicates the existence of an error condition. TRUE - An error is detected. FALSE - No error.
ErrorID	Output	UINT	A unique numeric that identifies the error. The errors for this instruction are defined in ABL error codes.

### ABL error codes

Use this table to determine the ABL error codes and descriptions.

Error code	Error description
03	Transmission cannot be completed because the Clear-to-Send signal was lost.
06	Illegal parameter was detected.
07	Cannot complete ASCII send or receive because channel configuration has been shut down using the channel configuration dialog box.
08	Cannot complete ASCII Write due to an ASCII transmission already in progress.
09	ASCII communication requested is not supported by current channel configuration.
10	The Cancel was set, stopping instruction execution. No action required.
11	The requested length for the string is either invalid, a negative number, greater than 82, or 0. Applies to ARD and ARL function blocks.



13	The requested (.LEN) in the control block is a negative number or a value greater than the string size stored with the source string. Applies to AWA and AWT function blocks.
14	The ACL function block was cancelled.
16	Serial port is not supporting RTS or CTS control lines.

### AWT Function Block Diagram example

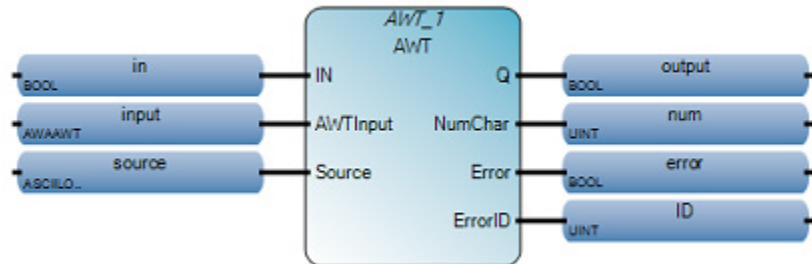

### AWT Ladder Diagram example

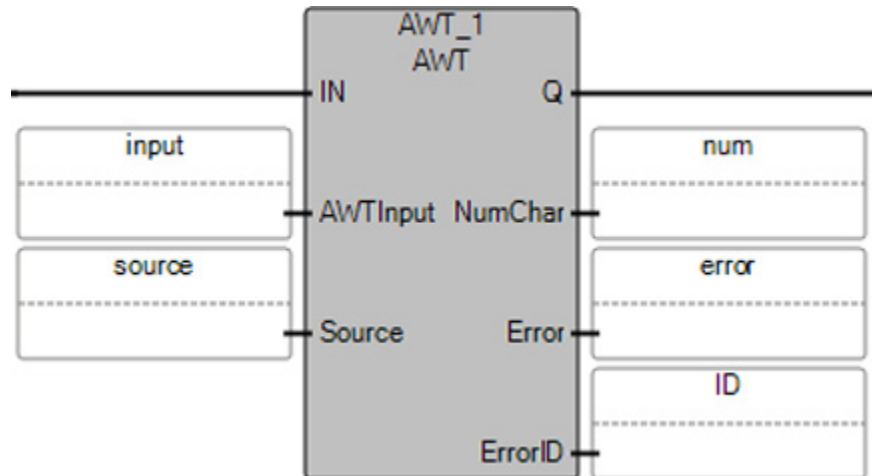

### AWT Structured Text example

```
AWT_1(
void AWT_1(BOOL IN, AWA/AWT AWTInput, ASCIILOCADDR Source)
Type : AWT, Write characters from a source string to an external device.
```

```
1 AWT_1(in, input, source);
2 output := AWT_1.Q;
3 num := AWT_1.NumChar;
4 error := AWT_1.Error;
5 ID := AWT_1.ErrorID;
```

### ASCII parameter details

The following topics provide additional details for ASCII parameters and structured data types.

- ABLACB data type
- ACL data type

- AHL ChannelSts data type
- AHLI data type
- ARDARL data type
- AWAAWT data type

## ABLACB data type

Use this table to help determine the parameter values for the ABLACB data type.

Parameter	Data type	Description
Channel	UINT	Serial port number: <ul style="list-style-type: none"> <li>• 2 for the embedded serial port, or</li> <li>• 5-9 for serial port plug-ins installed in slots 1 through 5:                             <ul style="list-style-type: none"> <li>• 5 for slot 1</li> <li>• 6 for slot 2</li> <li>• 7 for slot 3</li> <li>• 8 for slot 4</li> <li>• 9 for slot 5</li> </ul> </li> </ul>
TriggerType	USINT	Represents one of the following: <ul style="list-style-type: none"> <li>• 0: Msg Triggered Once (when IN goes from False to True)</li> <li>• 1: Msg triggered continuously when IN is True</li> <li>• Other value: Reserved</li> </ul>
Cancel	BOOL	When this input is set to TRUE, this function block does not execute.

## ACL data type

Use this table to help determine the parameter values for the ABL data type.

Parameter	Data type	Description
Channel	UINT	Serial port number: <ul style="list-style-type: none"> <li>• 2 for the embedded serial port, or</li> <li>• 5-9 for serial port plug-ins installed in slots 1 through 5:                             <ul style="list-style-type: none"> <li>• 5 for slot 1</li> <li>• 6 for slot 2</li> <li>• 7 for slot 3</li> <li>• 8 for slot 4</li> <li>• 9 for slot 5</li> </ul> </li> </ul>
RXBuffer	BOOL	When TRUE, clears the receive buffer and removes the receive ASCII function blocks (ARL and ARD) from the ASCII queue.
TXBuffer	BOOL	When TRUE, clears the transmit buffer and removes the transmit ASCII function blocks (AWA and AWT) from the ASCII queue.

## AHL ChannelSts data type

Use this table to help determine the parameter values for the AHL ChannelSts data type.

Parameter	Data type	Description
DTRstatus	UINT	Used for the DTR signal (reserved)
DCDstatus	UINT	Used for the DCD signal (bit 3 of word) 1 indicates active
DSRstatus	UINT	Used for the DSR signal (reserved)
RTSstatus	UINT	Used for the RTS signal (bit 1 of word) 1 indicates active

Parameter	Data type	Description
CTSstatus	UINT	Used for the CTS signal (bit 0 of word) 1 indicates active

## AHLI data type

Use this table to help determine the parameter values for the AHLI data type.

Parameter	Data type	Description
Channel	UINT	Serial port number: <ul style="list-style-type: none"> <li>• 2 for the embedded serial port, or</li> <li>• 5-9 for serial port plug-ins installed in slots 1 through 5: <ul style="list-style-type: none"> <li>• 5 for slot 1</li> <li>• 6 for slot 2</li> <li>• 7 for slot 3</li> <li>• 8 for slot 4</li> <li>• 9 for slot 5</li> </ul> </li> </ul>
ClrRts	BOOL	Used to reset the RTS control line.
SetRts	BOOL	Used to set the RTS control line.
Cancel	BOOL	When this input is set to TRUE, this function block does not execute.

## ARDARL data type

Use this table to help determine the parameter values for the ARDARL data type.

Parameter	Data type	Description
Channel	UINT	Serial port number: <ul style="list-style-type: none"> <li>• 2 for the embedded serial port, or</li> <li>• 5-9 for serial port plug-ins installed in slots 1 through 5: <ul style="list-style-type: none"> <li>• 5 for slot 1</li> <li>• 6 for slot 2</li> <li>• 7 for slot 3</li> <li>• 8 for slot 4</li> <li>• 9 for slot 5</li> </ul> </li> </ul>
Length	UINT	The number of characters that you want to read from the buffer (maximum is 82).
Cancel	BOOL	When this input is set to TRUE, this function block does not execute. If already executing, operation ceases.

## AWAAWT data type

Use this table to help determine the parameter values for the AWAAWT data type.

Parameter	Data type	Description
Channel	UINT	Serial port number: <ul style="list-style-type: none"> <li>• 2 for the embedded serial port, or</li> <li>• 5-9 for serial port plug-ins installed in slots 1 through 5: <ul style="list-style-type: none"> <li>• 5 for slot 1</li> <li>• 6 for slot 2</li> <li>• 7 for slot 3</li> <li>• 8 for slot 4</li> <li>• 9 for slot 5</li> </ul> </li> </ul>

**Chapter 6 ASCII serial port instructions**

<b>Parameter</b>	<b>Data type</b>	<b>Description</b>
Length	UINT	Defines the number of characters to write to the buffer (maximum is 82). When Length is set to 0, AWA sends 0 bytes of user data and 2 bytes of appended characters to the buffer.
Cancel	BOOL	When TRUE, this function block does not execute. If already executing, operation ceases.

## Binary instructions

Use Binary instructions to perform mathematical operations.

Operator	Description
<a href="#">AND_MASK</a> on <a href="#">page 125</a>	Performs a bit-to-bit AND between two Integer values.
<a href="#">NOT_MASK</a> on <a href="#">page 133</a>	Integer bit-to-bit negation mask, inverts a parameter value.
<a href="#">BSL</a> on <a href="#">page 126</a>	Shifts a bit in an array element to the left.
<a href="#">BSR</a> on <a href="#">page 130</a>	Shifts a bit in an array element to the right.
<a href="#">OR_MASK</a> on <a href="#">page 134</a>	Integer OR bit-to-bit mask, turns bits on.
<a href="#">ROL</a> on <a href="#">page 136</a>	For 32-bit integers, rotates integer bits to the left.
<a href="#">ROR</a> on <a href="#">page 137</a>	For 32-bit integers, rotates integer bits to the left.
<a href="#">SHL</a> on <a href="#">page 139</a>	For 32-bit integers, moves integers to the left and places 0 in the least significant bit.
<a href="#">SHR</a> on <a href="#">page 141</a>	For 32-bit integers, moves integers to the right and places 0 in the most significant bit.
<a href="#">XOR_MASK</a> on <a href="#">page 143</a>	Integer exclusive OR bit-to-bit mask, returns inverted bit values.

### AND\_MASK (AND mask)

Performs a bit to bit AND between two integer values.

Languages supported: Function Block Diagram, Ladder Diagram, Structured Text.

This instruction applies to the Micro810, Micro820, Micro830, Micro850, Micro870 controllers and Micro800 Simulator.

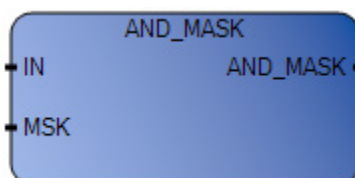

Use this table to help determine the parameter values for this instruction.

Parameter	Parameter Type	Data Type	Description
EN	Input	BOOL	Instruction enable. TRUE - execute the Integer AND bit-to-bit mask computation. FALSE - there is no computation. Applies to Ladder Diagram programs.
IN	Input	DINT	Must have integer format.
MSK	Input	DINT	Must have integer format.
AND_MASK	Output	DINT	Bit-to-bit logical AND between IN and MSK.
ENO	Output	BOOL	Enable output. Applies to Ladder Diagram programs.

### AND\_MASK Function Block Diagram example

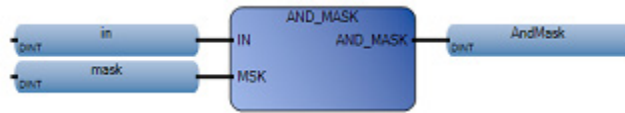

### AND\_MASK Ladder Diagram example

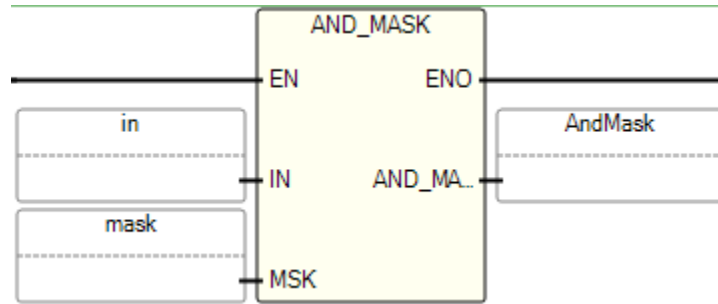

### AND\_MASK Structured Text example

```
AND_MASK(
DINT AND_MASK(DINT IN, DINT MSK)
Analog bit to bit AND mask
```

```
1 in := 5;
2 mask := 6;
3 AndMask := AND_MASK(in, mask);
```

(\* ST Equivalence: \*)

parity := AND\_MASK (xvalue, 1); (\* 1 if xvalue is odd \*)

result := AND\_MASK (16#abc, 16#fof); (\* equals 16#aoc \*)

### Results

Name	Logical Value	Physical Value	Initial Value	Lock	Data Type
mask	6	N/A		<input type="checkbox"/>	DINT
in	5	N/A		<input type="checkbox"/>	DINT
AndMask	4	N/A		<input checked="" type="checkbox"/>	DINT

### BSL (bit shift left)

Shifts a bit in an array element to the left.

Languages supported: Function Block Diagram, Ladder Diagram, Structured Text.

This instruction applies to the Micro820, Micro830, Micro850, Micro870 controllers and Micro800 Simulator.

Operation details:

The BSL instruction is an immediate process on false-to-true rung transition and updates output synchronously. When Execute is TRUE, the leftmost bit (Src + SrcOffset and Length) is copied into the Unload bit and all bits in the array or non-array are shifted left by one bit. Length and 16 bit boundary are considered except for BOOL data types. The external bit is then moved to bit 0 (Src + SrcOffset) of the first element.

For wraparound operations, set the position of the BitAddr to the last bit position or to the Unload bit. Possible usage of the BSL instruction, track bottles through a bottling line where each bit represents a bottle.

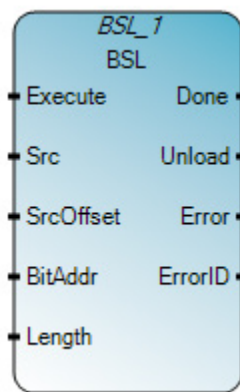

Use this table to help determine the parameter values for this instruction.

Parameter	Parameter Type	Data Type	Description
Execute	Input	BOOL	Instruction enable. TRUE - Rising Edge detected, shifts bit to the left one position. <ul style="list-style-type: none"> <li>Verify fault conditions first.</li> <li>If Length = 0, the external bit is moved into the Unload bit. No bit shift is done on Src. Error and ErrorID bits are reset. Done bit is set.</li> <li>If Length &gt; 0 and Length ≤ 2048, the Error and ErrorID bits are reset. After the bit shift completes, the Done bit is set.</li> <li>If Length &gt; 0 and Length ≤ 2048, the leftmost bit (addressed by Src + SrcOffset and Length) is copied into the Unload bit and all bits that are part of the array or non-array are shifted left by one bit (up to the bit Length and 16-bit boundary except for BOOL). External bit is moved to bit 0 (Src + SrcOffset) of the first element.</li> </ul> FALSE - Rising Edge not detected, do not enable BSL operation.
Src	Input	ANY_ELEMENTARY	The address of the Src (bit) to be shifted. Supported data types: BOOL, DWORD, INT, UINT, WORD, DINT and UDINT. <ul style="list-style-type: none"> <li>Arrays: Set Src to a variable based address such as: Source1, Source1[0], or Source1[1].</li> <li>Non-arrays: Set Src to a variable address such as Source1.</li> </ul>
SrcOffset	Input	UINT	If SrcOffset is 0, start from the first element. <ul style="list-style-type: none"> <li>Arrays: Set SrcOffset to 0. If set to Source1[0] or Source1[1] an error occurs: 'Source offset exceeds the size of the array.'</li> <li>Non-arrays: Set SrcOffset to 0 or an error occurs: 'Source offset exceeds the size of the array.'</li> </ul>
BitAddr	Input	BOOL	Location of the bit shifted into Src.

Length	Input	UINT	Length contains the number of bits in the Src to be shifted. Supports shifting across array elements. <ul style="list-style-type: none"> <li>• For BOOL data type, number of Booleans in the array to be shifted.</li> <li>• For 16- and 32-bit data types, bits are shifted in multiples of 16 (such as 16, 32, and 64). If Length is not an even multiple of 16, the number of shifted bits is sent to the next 16-bit boundary.</li> <li>• Length is based on the size of the data type. If Length exceeds the range, an error occurs, 'Source offset exceeds the size of the array.' Length values: <ul style="list-style-type: none"> <li>• BOOL: 1</li> <li>• 16-bit word: 1-16</li> <li>• 32-bit word: 1-32</li> <li>• 64-bit word: 1-64</li> </ul> </li> </ul>
Done	Output	BOOL	When TRUE, operation completed successfully. When FALSE, operation encountered an error condition.
Unload	Output	BOOL	Bit shifted out from Src address.
Error	Output	BOOL	When a fault occurs, Error is set to true.
ErrorID	Output	USINT	When a fault occurs, ErrorID contains the error code.

**BSL error codes**

Error code	Error description
01	Not supported dimension.
02	Data type not supported.
03	Length of bits exceeds 2048.
04	Source offset exceeds the size of the array.
05	Length of bits exceeds the size of the array.
07	Invalid parameters.

**BSL Function Block Diagram example**

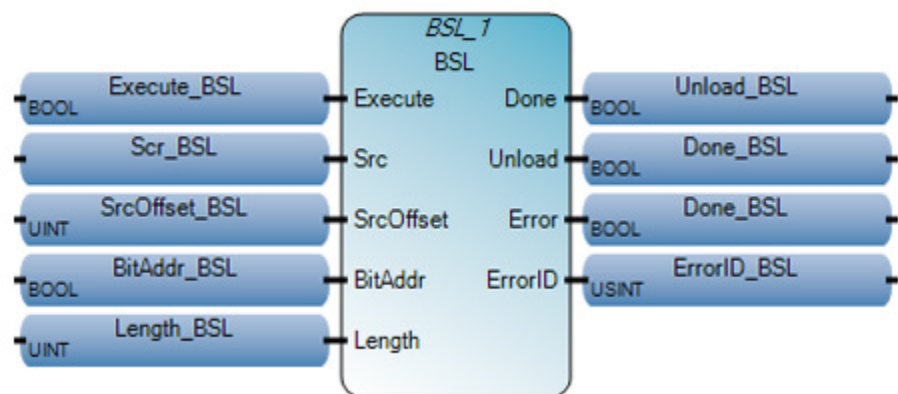



## BSL Ladder Diagram example

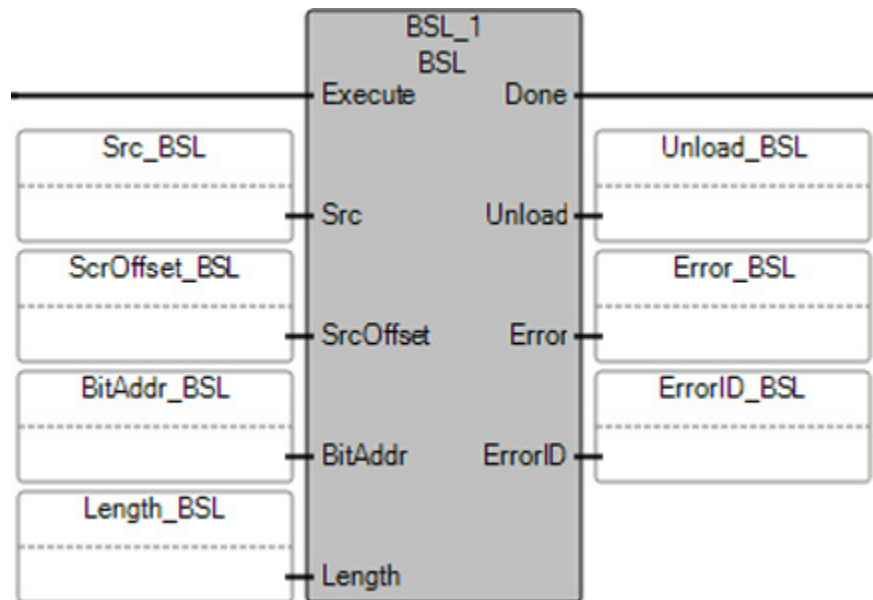

## BSL Structured Text example

```
BSL_1(
void BSL_1(BOOL Execute, ANY_ELEMENTARY[1..1] Src, UINT SrcOffset, BOOL BitAddr, UINT Length)
Type : BSL, Performs bit shift left operation.
```

```
1 BSL_1(Execute,Src,SrcOffset,BitAddr,Length);
2 Done_BSL := BSL_1.Done;
3 Unload_BSL := BSL_1.Unload;
4 Error_BSL := BSL_1.Error;
5 ErrorID_BSL := BSL_1.ErrorID;
```

## Results

Name	Alias	Logical Val	Physical Val	Initial Valu	Lock	Data Type	Dimension
+ BSL_1		...	...	...	<input type="checkbox"/>	BSL	
Execute		<input type="checkbox"/>	N/A		<input type="checkbox"/>	BOOL	
+ Src		...	...	...	<input type="checkbox"/>	DINT	[1..4]
SrcOffset		0	N/A		<input type="checkbox"/>	UINT	
BitAddr		<input type="checkbox"/>	N/A		<input type="checkbox"/>	BOOL	
Length		0	N/A		<input type="checkbox"/>	UINT	
Done_BSL		<input type="checkbox"/>	N/A		<input type="checkbox"/>	BOOL	
Unload_BSL		<input type="checkbox"/>	N/A		<input type="checkbox"/>	BOOL	
Error_BSL		<input type="checkbox"/>	N/A		<input type="checkbox"/>	BOOL	
ErrorID_BSL		0	N/A		<input type="checkbox"/>	USINT	

## BSR (bit shift right)

Shifts a bit in an array element to the right.

Languages supported: Function Block Diagram, Ladder Diagram, Structured Text.

This instruction applies to the Micro820, Micro830, Micro850, Micro870 controllers and Micro800 Simulator.

Operation details:

The BSR instruction is an immediate process on false-to-true rung transition and updates output synchronously. When Execute is TRUE, the right most bit (bit 0 of the element addressed by Src + SrcOffset) is copied into the Unload bit and all bits in the array or non-array are shifted right by one bit. Length and 16 bit boundary are considered except for BOOL data types. The external bit is then moved to bit 0 (Src + SrcOffset) of the first element.

For wraparound operations, set the position of the BitAddr to the last bit position or to the Unload bit. Possible usage of the BSL instruction, track bottles through a bottling line where each bit represents a bottle.

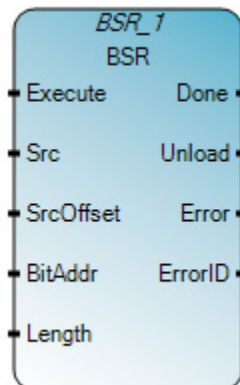

Use this table to help determine the parameter values for this instruction.

Parameter	Parameter Type	Data Type	Description
-----------	----------------	-----------	-------------

Execute	Input	BOOL	Instruction enable. TRUE - Rising Edge detected, shifts bit to the right one position. FALSE - Rising Edge not detected, do not enable BSR operation.
Scr	Input	ANY_ELEMENTARY	The address of the Src (bit) to be shifted. Supported data types: BOOL, DWORD, INT, UINT, WORD, DINT and UDINT. <ul style="list-style-type: none"> <li>• Arrays: Set Scr to a variable based address such as: Source1, Source1[0], or Source1[1].</li> <li>• Non-arrays: Set Scr to a variable address such as Source1.</li> </ul>
SrcOffset	Input	UINT	If SrcOffset is 0, start from the first element. <ul style="list-style-type: none"> <li>• Arrays: Set SrcOffset to 0. If set to Source1[0] or Source1[1] an error occurs: 'Source offset exceeds the size of the array.'</li> <li>• Non-arrays: Set SrcOffset to 0 or an error occurs: 'Source offset exceeds the size of the array.'</li> </ul>
BitAddr	Input	BOOL	Location of the bit shifted into Src.
Length	Input	UINT	Length contains the number of bits in the Src to be shifted. Supports shifting across array elements. <ul style="list-style-type: none"> <li>• For BOOL data type, number of Booleans in the array to be shifted.</li> <li>• For 16- and 32-bit data types, bits are shifted in multiples of 16 (such as 16, 32, and 64). If Length is not an even multiple of 16, the number of shifted bits is to the next 16-bit boundary.</li> <li>• Length is based on the size of the data type. If Length exceeds the range, an error occurs, 'Source offset exceeds the size of the array.' Length values: <ul style="list-style-type: none"> <li>• BOOL: 1</li> <li>• 16-bit word: 1-16</li> <li>• 32-bit word: 1-32</li> <li>• 64-bit word: 1-64</li> </ul> </li> </ul>
Done	Output	BOOL	When TRUE, operation completed successfully. When FALSE, operation encountered an error condition.
Unload	Output	BOOL	Bit shifted out from Src address.
Error	Output	BOOL	When a fault occurs, Error is set to true.
ErrorID	Output	USINT	When a fault occurs, ErrorID contains error code.

### BSR error codes

Error code	Error description
01	Not supported dimension.
02	Data type not supported.
03	Length of bits exceeds 2048.
04	Source offset exceeds the size of the array.
05	Length of bits exceeds the size of the array.
07	Invalid parameters.

### BSR Function Block Diagram example

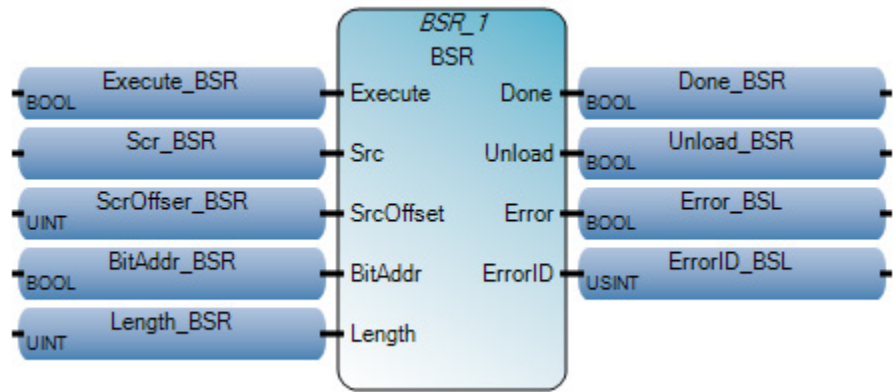

### BSR Ladder Diagram example

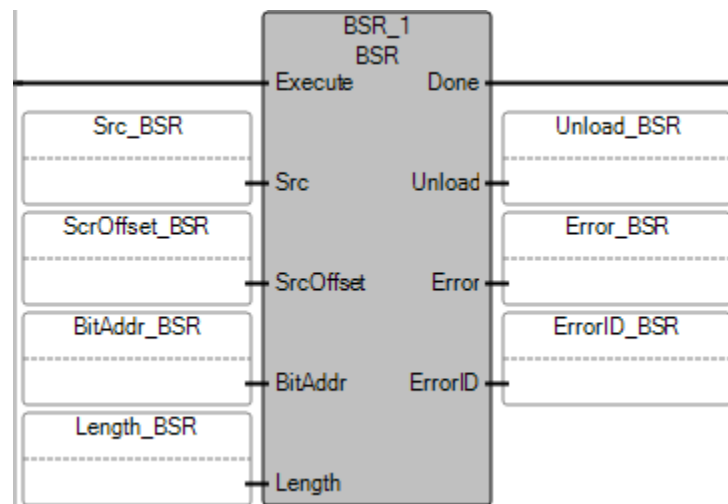

### BSR Structured Text example

```

1 BSR_1(
    void BSR_1(BOOL Execute, ANY_ELEMENTARY[1..1] Src, UINT SrcOffset, BOOL BitAddr, UINT Length)
    Type : BSR, Performs bit shift right operation

1 BSR_1(Execute, Src, SrcOffset, BitAddr, Length) ;
2 Done_BSR := BSR_1.Done;
3 Unload_BSR := BSR_1.Unload;
4 Error_BSR := BSR_1.Error;
5 ErrorID_BSR := BSR_1.ErrorID;
    
```

### Results

Name	Alias	Logical Val	Physical Val	Initial Val	Lock	Data Type	Dimension
+ BSR_1		...	...	...	<input type="checkbox"/>	BSR	
Execute		<input type="checkbox"/>	N/A		<input type="checkbox"/>	BOOL	
+ Scr		...	...	...	<input type="checkbox"/>	DINT	[1..4]
SrcOffset		0	N/A		<input type="checkbox"/>	UINT	
BitAddr		<input type="checkbox"/>	N/A		<input type="checkbox"/>	BOOL	
Length		0	N/A		<input type="checkbox"/>	UINT	
Done_BSR		<input type="checkbox"/>	N/A		<input type="checkbox"/>	BOOL	
Unload_BSR		<input type="checkbox"/>	N/A		<input type="checkbox"/>	BOOL	
Error_BSR		<input type="checkbox"/>	N/A		<input type="checkbox"/>	BOOL	
ErrorID_BSR		0	N/A		<input type="checkbox"/>	USINT	

### NOT\_MASK (bit to bit NOT mask)

Integer bit-to-bit negation mask, inverts a parameter value.

Languages supported: Function Block Diagram, Ladder Diagram, Structured Text.

This instruction applies to the Micro810, Micro820, Micro830, Micro850, Micro870 controllers and Micro800 Simulator.

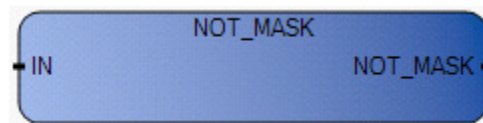

Use this table to help determine the parameter values for this instruction.

Parameter	Parameter Type	Data Type	Description
EN	Input	BOOL	Instruction enable. TRUE - execute the bit-to-bit negation mask computation. FALSE - there is no computation. Applies to Ladder Diagram programs.
IN	Input	DINT	Must have integer format.
NOT_MASK	Output	DINT	Bit-to-bit negation on 32 bits of IN.
ENO	Output	BOOL	Enable output. Applies to Ladder Diagram programs.

### NOT\_MASK Function Block Diagram example

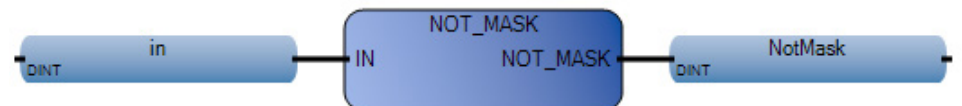

### NOT\_MASK Ladder Diagram example

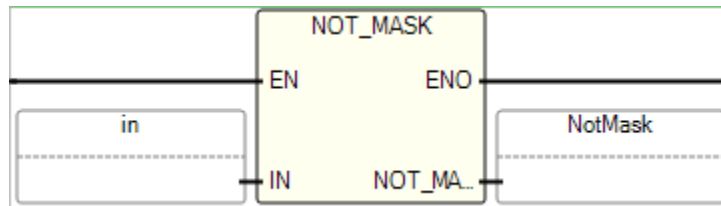

### NOT\_MASK Structured Text example

```
NOT_MASK(
  DINT NOT_MASK(DINT IN)
  bit to bit negation
```

```
1 in := 6;
2 NotMask := NOT_MASK(in);
```

(\*ST equivalence: \*)

result := NOT\_MASK (16#1234);

(\* result is 16#FFFF\_EDCB \*)

### Results

Name	Alias	Logical Value	Physical Value	Initial Value	Lock	Data
in		6	N/A		<input type="checkbox"/>	DINT
NotMask		-7	N/A		<input checked="" type="checkbox"/>	DINT

### OR\_MASK (bit to bit OR mask)

Integer OR bit-to-bit mask, turns bits on.

Languages supported: Function Block Diagram, Ladder Diagram, Structured Text.

This instruction applies to the Micro810, Micro820, Micro830, Micro850, Micro870 controllers and Micro800 Simulator.

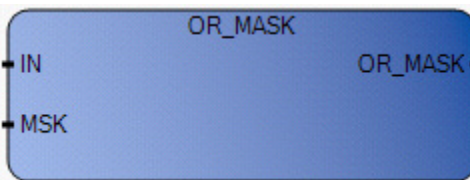

Use this table to help determine the parameter values for this instruction.

Parameter	Parameter Type	Data Type	Description
-----------	----------------	-----------	-------------

EN	Input	BOOL	Instruction enable. TRUE - execute the Integer OR bit-to-bit mask computation. FALSE - there is no computation. Applies to Ladder Diagram programs.
IN	Input	DINT	Must have integer format.
MSK	Input	DINT	Must have integer format.
OR_MASK	Output	DINT	Bit-to-bit logical OR between IN and MSK.
ENO	Output	BOOL	Enable output. Applies to Ladder Diagram programs.

### OR\_MASK Function Block Diagram example

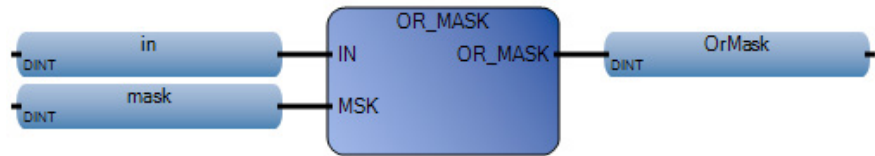

### OR\_MASK Ladder Diagram example

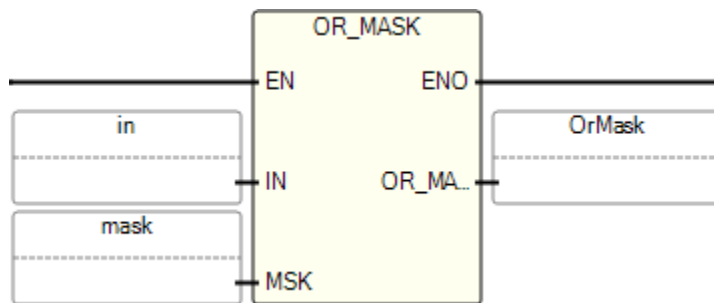

### OR\_MASK Structured Text examples

```
OR_MASK {
  DINT OR_MASK(DINT IN, DINT MSK)
  Analog bit to bit OR mask
```

```
1 in := 3;
2 mask := 6;
3 OrMask := OR_MASK(in, mask);
```

(\* ST Equivalence: \*)

parity := OR\_MASK (xvalue, 1); (\* makes value always odd \*)

result := OR\_MASK (16#abc, 16#f0f); (\* equals 16#fbf \*)

## Results

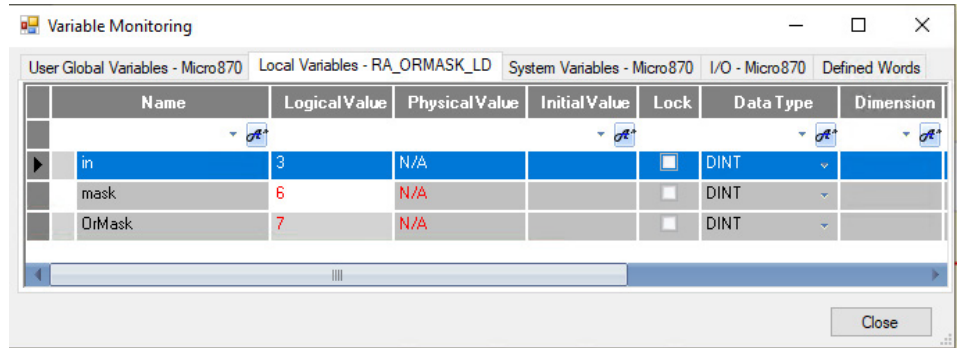

## ROL (rotate left)

Rotates the DINT type input by NbR bits to the left in a circular form and fills the bits on the right with the bits that are rotated.

Languages supported: Function Block Diagram, Ladder Diagram, Structured Text.

This instruction applies to the Micro810, Micro820, Micro830, Micro850, Micro870 controllers and Micro800 Simulator.

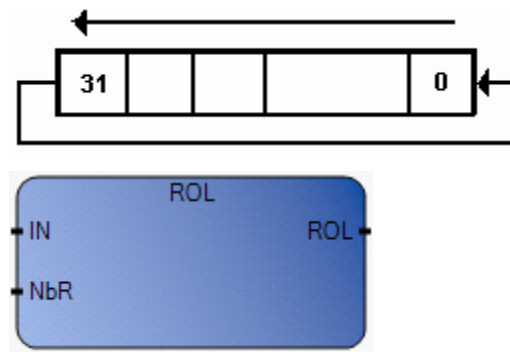

Use this table to help determine the parameter values for this instruction.

Parameter	Parameter Type	Data Type	Description
EN	Input	BOOL	Instruction enable. TRUE - execute the rotate bits left integer value computation. FALSE - there is no computation. Applies to Ladder Diagram programs.
IN	Input	DINT	Integer value.
NbR	Input	DINT	Number of 1-bit rotations (in set [1..31]).
ROL	Output	DINT	Left rotated value. When NbR <= 0, no change occurs.
ENO	Output	BOOL	Enable output. Applies to Ladder Diagram programs.

## ROL Function Block Diagram example

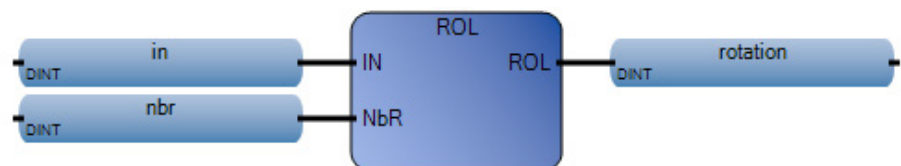



## ROL Ladder Diagram example

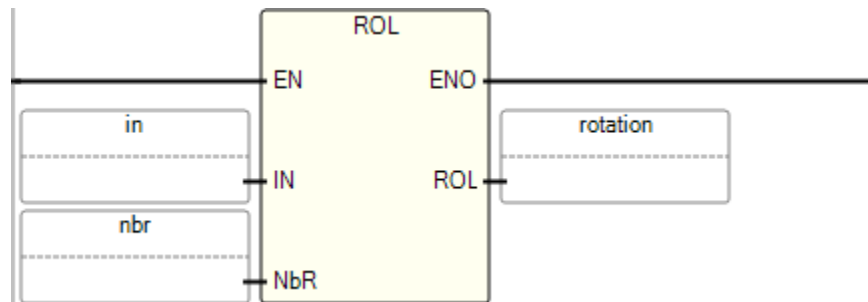

## ROL Structured Text example

```

ROL (
  DINT ROL(DINT IN, DINT NbR)
  Rotate Left

1  in := 123;
2  nbr := 2;
3  rotation := ROL(in, nbr);

```

(\* ST Equivalence: \*)

result := ROL (register, 1);

(\* register = 2#0100\_1101\_0011\_0101\*)

(\* result = 2#1001\_1010\_0110\_1010\*)

## Results

Name	Logical Value	Physical Value	Initial Value	Lock	Data Type	Dimension
rotation	492	N/A		<input type="checkbox"/>	DINT	
nbr	2	N/A		<input type="checkbox"/>	DINT	
in	123	N/A		<input checked="" type="checkbox"/>	DINT	

## ROR (rotate right)

Rotate the DINT type input by NbR bits to right in a circular form and fills the bits on the left with the bits that are rotated.

Languages supported: Function Block Diagram, Ladder Diagram, Structured Text.

This instruction applies to the Micro810, Micro820, Micro830, Micro850, Micro870 controllers and Micro800 Simulator.

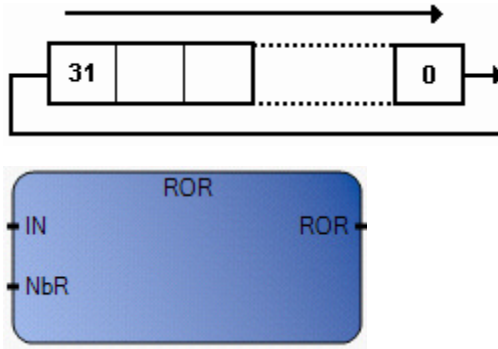

Use this table to help determine the parameter values for this instruction.

Parameter	Parameter Type	Data Type	Description
EN	Input	BOOL	Instruction enable. TRUE - execute the rotate bits right integer value computation. FALSE - there is no computation. Applies to Ladder Diagram programs.
IN	Input	DINT	Any integer value.
NbR	Input	DINT	Number of 1-bit rotations (in set [1..31]).
ROR	Output	DINT	Right rotated value. There is no effect if NbR <= 0.
ENO	Output	BOOL	Enable output. Applies to Ladder Diagram programs.

### ROR Function Block Diagram example

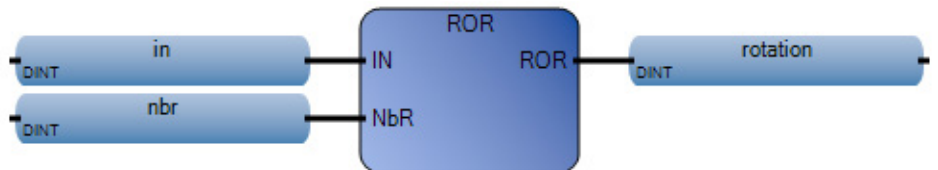

### ROR Ladder Diagram example

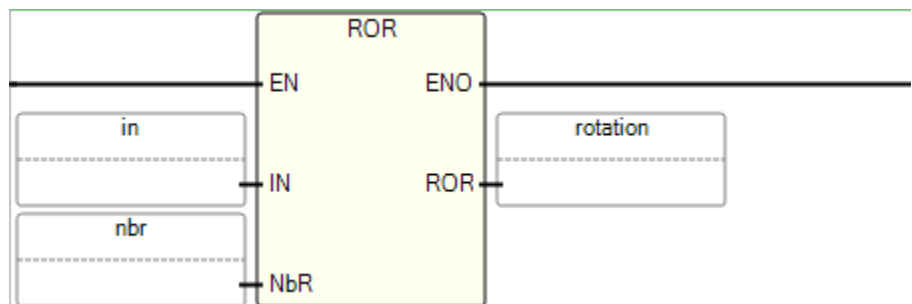

### ROR Structured Text example

```
ROR (
  DINT ROR(DINT IN, DINT Nbr)
  Rotate Right
```

```
1 in := 123;
2 nbr := 2;
3 rotation := ROR(in, nbr);
```

(\* ST Equivalence: \*)

result := ROR (register, 1);

(\* register = 2#0100\_1101\_0011\_0101 \*)

(\* result = 2#1010\_0110\_1001\_1010 \*)

### Results

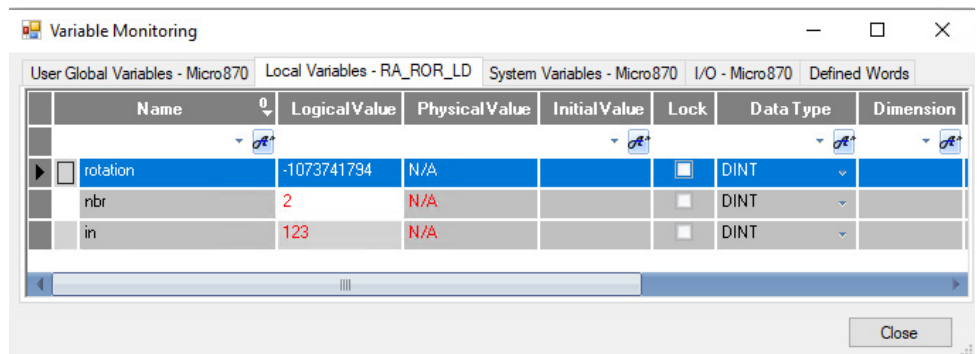

### SHL (shift left)

For 32-bit integers, moves integers to the left and places 0 in the least significant bit.

Languages supported: Function Block Diagram, Ladder Diagram, Structured Text.

This instruction applies to the Micro810, Micro820, Micro830, Micro850, Micro870 controllers and Micro800 Simulator.



Use this table to help determine the parameter values for this instruction.

Parameter	Parameter Type	Data Type	Description
-----------	----------------	-----------	-------------

EN	Input	BOOL	Instruction enable. TRUE - move integers to the left. FALSE - there is no integer movement. Applies to Ladder Diagram programs.
IN	Input	DINT	Any integer value.
NbS	Input	DINT	Number of 1 bit shifts (in set [1..31]).
SHL	Output	DINT	Left shifted value. There is no effect if NbS <= 0. If a value of 0, replaces the least significant bit.
ENO	Output	BOOL	Enable output. Applies to Ladder Diagram programs.

### SHL Function Block Diagram example

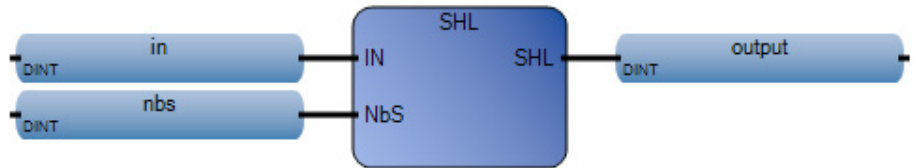

### SHL Ladder Diagram example

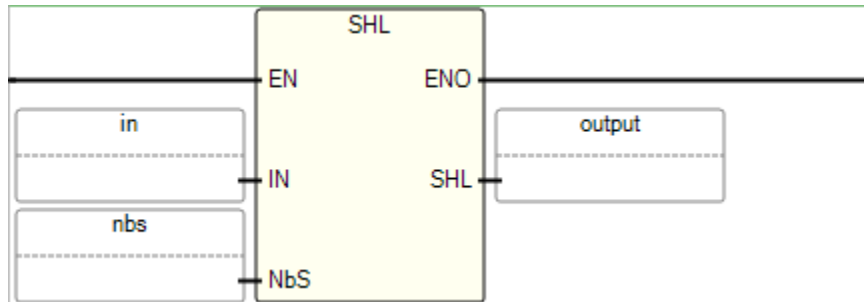

### SHL Structured Text example

```
SHL (
  DINT SHL(DINT IN, DINT NbS)
  Shift Left
```

```
1 in := 123;
2 nbs := 2;
3 output := SHL(in, nbs);
```

(\* ST Equivalence: \*)

result := SHL (register,1);

(\* register = 2#0100\_1101\_0011\_0101 \*)

(\* result = 2#1001\_1010\_0110\_1010 \*)

## Results

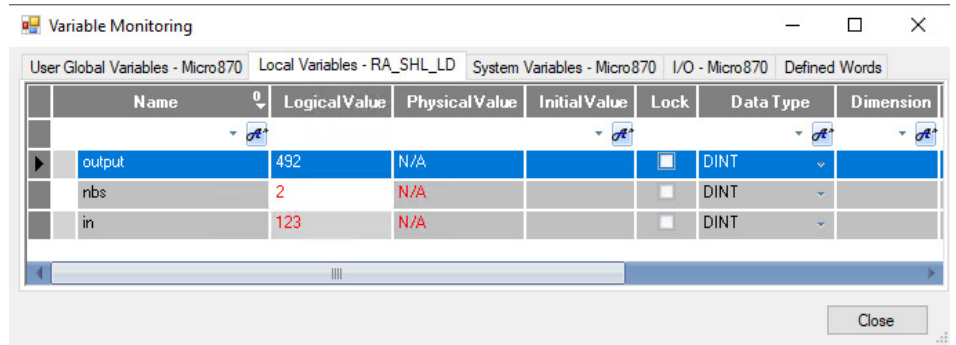

## SHR (shift right)

Shifts the 32 bits of an integer to the right and replicates the leftmost bit (significant bit) to fill the vacant bits.

Languages supported: Function Block Diagram, Ladder Diagram, Structured Text.

This instruction applies to the Micro810, Micro820, Micro830, Micro850, Micro870 controllers and Micro800 Simulator.

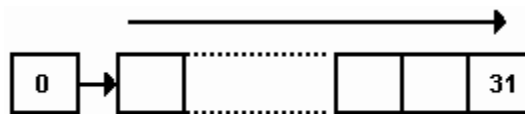

Use this table to help determine the parameter values for this instruction.

Parameter	Parameter Type	Data Type	Description
EN	Input	BOOL	Instruction enable. TRUE - move integers to the right. FALSE - there is no integer movement. Applies to Ladder Diagram programs.
IN	Input	DINT	Any integer value.
NbS	Input	DINT	Number of 1 bit shifts (in set [1..31]).
SHR	Output	DINT	Right shifted value. There is no effect if NbS <= 0. If a value of 0, replaces the most significant bit.
ENO	Output	BOOL	Enable output. Applies to Ladder Diagram programs.

### SHR Function Block Diagram example

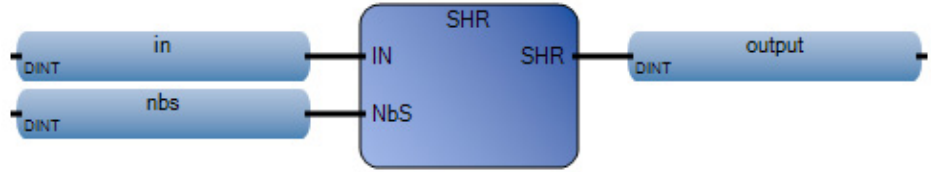

### SHR Ladder Diagram example

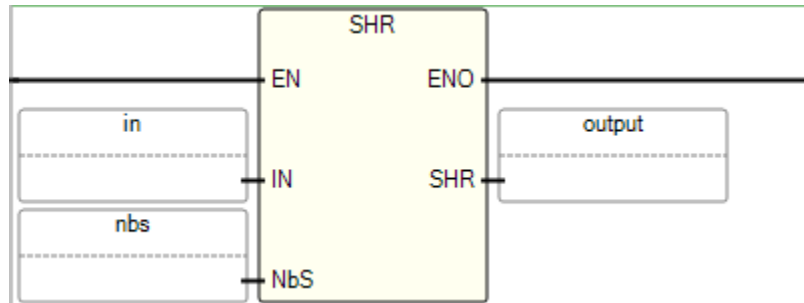

### SHR Structured Text example

```
SHR (
  DINT SHR(DINT IN, DINT NbS)
  Shift Right
```

```
1 in := 123;
2 nbs := 2;
3 output := SHR(in, nbs);
```

(\* ST Equivalence: \*)

result := SHR (register,1);

(\* register = 2#1100\_1101\_0011\_0101 \*)

(\* result = 2#0110\_0110\_1001\_1010 \*)

### Results

The Variable Monitoring window displays the following data:

Name	Logical Value	Physical Value	Initial Value	Lock	Data Type	Dimension
output	30	N/A		<input type="checkbox"/>	DINT	
nbs	2	N/A		<input type="checkbox"/>	DINT	
in	123	N/A		<input type="checkbox"/>	DINT	

## XOR\_MASK (exclusive OR mask)

Integer exclusive OR bit-to-bit mask, returns inverted bit values.

Languages supported: Function Block Diagram, Ladder Diagram, Structured Text.

This instruction applies to the Micro810, Micro820, Micro830, Micro850, Micro870 controllers and Micro800 Simulator.

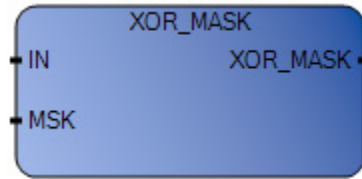

Use this table to help determine the parameter values for this instruction.

Parameter	Parameter Type	Data Type	Description
EN	Input	BOOL	Instruction enable. TRUE - perform the exclusive OR bit-to-bit mask computation. FALSE - there is no computation. Applies to Ladder Diagram programs.
IN	Input	DINT	Must have integer format.
MSK	Input	DINT	Must have integer format.
XOR_MASK	Output	DINT	Bit-to-bit logical Exclusive OR between IN and MSK.
ENO	Output	BOOL	Enable output. Applies to Ladder Diagram programs.

### XOR\_MASK Function Block Diagram example

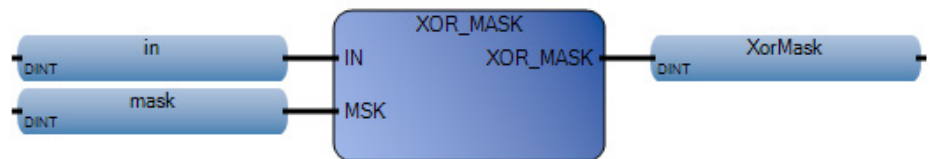

### XOR\_MASK Ladder Diagram example

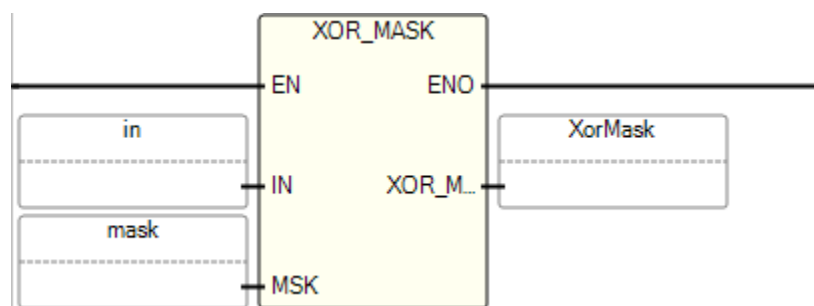

## XOR\_MASK Structured Text example

```
XOR_MASK(
  DINT XOR_MASK(DINT IN, DINT MSK)
  Analog bit to bit Exclusive OR mask
```

```
1 in := 5;
2 mask := 6;
3 XorMask := XOR_MASK(in, mask);
```

(\* ST Equivalence: \*)

crc32 := XOR\_MASK (prevcrc, nextc);

result := XOR\_MASK (16#012, 16#011); (\* equals 16#003 \*)

## Results

Name	Logical Value	Physical Value	Initial Value	Lock	Data Type	Dimension
XorMask	3	N/A		<input type="checkbox"/>	DINT	
mask	6	N/A		<input type="checkbox"/>	DINT	
in	5	N/A		<input type="checkbox"/>	DINT	



## Boolean instructions

Use Boolean instructions to determine an output value based on a logical calculation from inputs. The module outputs can be directly controlled from the program or independently controlled by the module using the Boolean instructions.

Function	Description
<a href="#">MUX4B</a> on <a href="#">page 160</a>	Multiplexer between four BOOL inputs, outputs a BOOL value.
<a href="#">MUX8B</a> on <a href="#">page 156</a>	Multiplexer between eight BOOL inputs, outputs a BOOL value.
<a href="#">ITABLE</a> on <a href="#">page 153</a>	Provides the value of the output based on the combination of inputs.
Function block	Description
<a href="#">F_TRIG</a> on <a href="#">page 145</a>	Detects a falling edge of a Boolean variable.
<a href="#">RS</a> on <a href="#">page 148</a>	Reset dominant (highest priority when determining instruction behavior) bistable.
<a href="#">R_TRIG</a> on <a href="#">page 147</a>	Detects a rising edge of a Boolean variable.
<a href="#">SR</a> on <a href="#">page 152</a>	Set dominant bistable.
Operator	Description
<a href="#">AND</a> on <a href="#">page 150</a>	Performs a boolean AND operation between two or more values.
<a href="#">NOT</a> on <a href="#">page 151</a>	Converts Boolean values to negated values.
<a href="#">XOR</a> on <a href="#">page 151</a>	Boolean exclusive OR of two values.
<a href="#">OR</a> on <a href="#">page 149</a>	Boolean OR of two or more values.

### F\_TRIG (falling edge detection)

Detects a falling edge of a Boolean variable. The F\_TRIG block sets output Q for one cycle when input CLK toggles from set to cleared (i.e., a falling edge is detected at input CLK).

Languages supported: Function Block Diagram, Ladder Diagram, Structured Text.

This instruction applies to the Micro810, Micro820, Micro830, Micro850, Micro870 controllers and Micro800 Simulator.

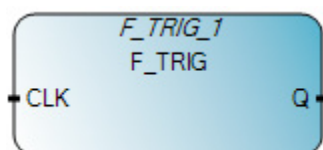

Use this table to help determine the parameter values for this instruction.

Parameter	Parameter Type	Data Type	Description

CLK	Input	BOOL	Checks the input for a falling edge. Any Boolean variable. TRUE = No falling edge detected. FALSE = Falling edge detected on input CLK, set output Q to TRUE.
Q	Output	BOOL	Indicates status for Q output. TRUE = Falling edge detected, sets output Q for one more cycle. FALSE = No change to output Q.

### F\_TRIG Function Block Diagram example

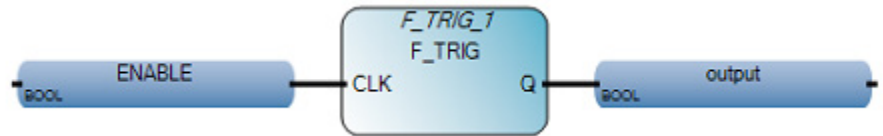

### F\_TRIG Ladder Diagram example

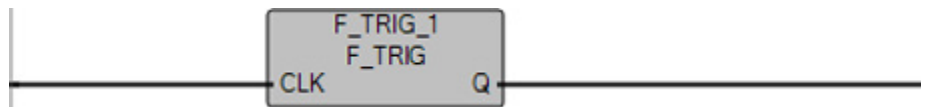

### F\_TRIG Structured Text example

```
F_TRIG_1(
void F_TRIG_1(BOOL CLK)
Type : F_TRIG, Falling edge detection
```

```
1 F_TRIG_1(ENABLE);
2 IF F_TRIG_1.Q THEN
3     output := TRUE;
4 END_IF;
```

(\* ST Equivalence: F\_TRIG1 is an instance of a F\_TRIG block \*)

```
F_TRIG1 (cmd);
nb_edge := ANY_TO_DINT(F_TRIG1.Q) + nb_edge;
```

## Results

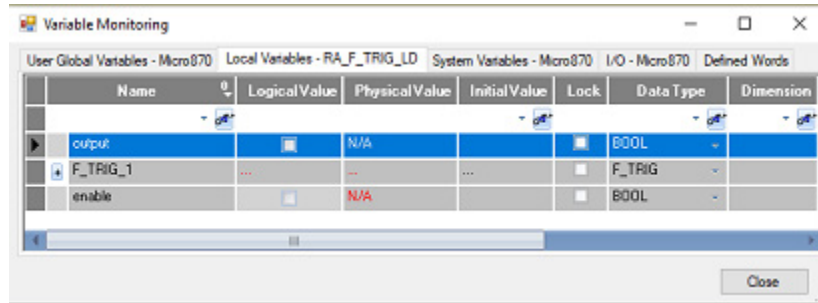

## R\_TRIG (rising edge detector)

Detects a rising edge of a Boolean variable. The R\_TRIG block sets output Q for one cycle when input CLK toggles from cleared to set (i.e., a rising edge is detected at input CLK).

Languages supported: Function Block Diagram, Ladder Diagram, Structured Text.

This instruction applies to the Micro810, Micro820, Micro830, Micro850, Micro870 controllers and Micro800 Simulator.

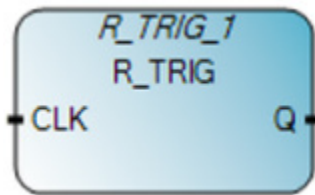

Use this table to help determine the parameter values for this instruction.

Parameter	Parameter Type	Data Type	Description
CLK	Input	BOOL	Any Boolean variable. TRUE - Rising Edge detected, set Q to TRUE. FALSE - no Rising Edge detected, set Q to FALSE.
Q	Output	BOOL	TRUE - when CLK is TRUE. FALSE - in all other cases.

### R\_TRIG Function Block Diagram example

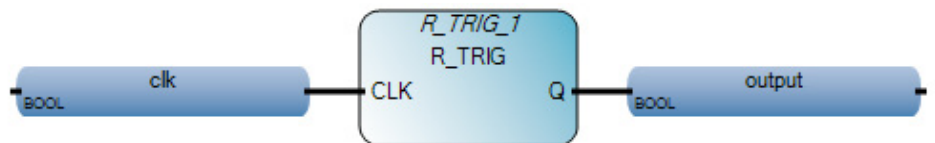

### R\_TRIG Ladder Diagram example

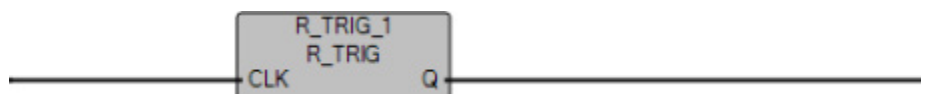

## R\_TRIG Structured Text example

```
R_TRIG_1(
void R_TRIG_1(BOOL CLK)
Type : R_TRIG, Rising edge detection
```

(\* ST Equivalence: R\_TRIG1 is an instance of a R\_TRIG block \*)

```
R_TRIG1 (cmd) ;
nb_edge := ANY_TO_DINT(R_TRIG1.Q) + nb_edge;
```

## Results

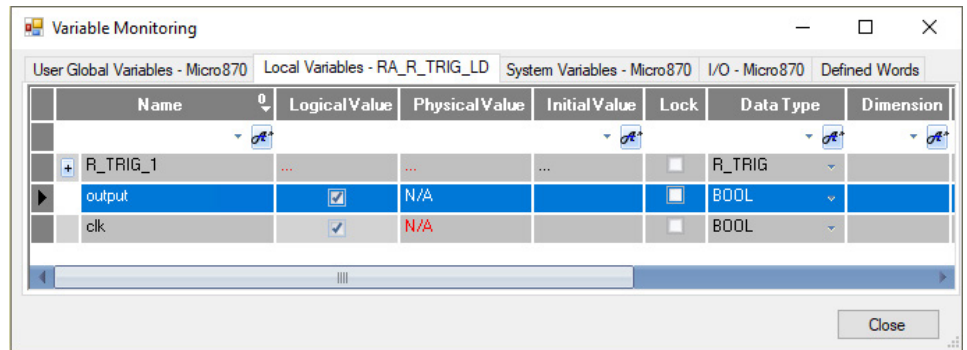

## RS (reset/set)

Resets or sets the dominant (highest priority when determining instruction behavior) bistable.

Languages supported: Function Block Diagram, Ladder Diagram, Structured Text.

This instruction applies to the Micro810, Micro820, Micro830, Micro850, Micro870 controllers and Micro800 Simulator.



Use this table to help determine the parameter values for this instruction.

Parameter	Parameter Type	Data Type	Description
SET	Input	BOOL	TRUE - sets Q1 to TRUE.
RESET1	Input	BOOL	TRUE - resets Q1 to FALSE (dominant).
Q1	Output	BOOL	Boolean memory state.

## RS Function Block Diagram example

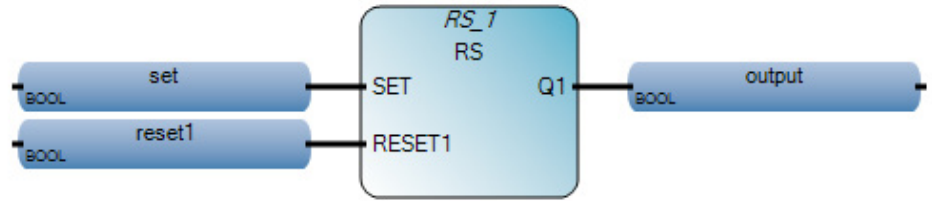

## RS Ladder Diagram example

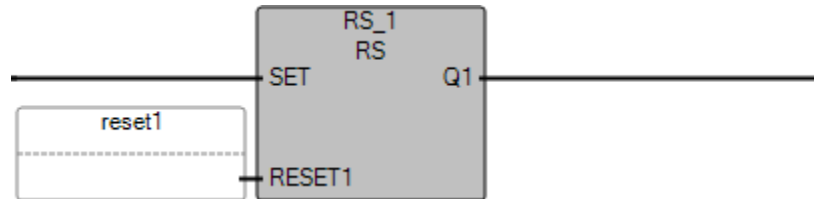

## RS Structured Text example

```
RS_1 (
  void RS_1(BOOL SET, BOOL RESET1)
  Type : RS, Reset dominant bistable
```

```
1 set := TRUE;
2 reset1 := FALSE;
3 RS_1(set, reset1);
4 output := RS_1.Q1;
```

(\* ST Equivalence: RS1 is an instance of a RS block \*)

```
RS1(start_cmd, (stop_cmd OR alarm));
command := RS1.Q1;
```

## Results

Variable Monitoring window showing the state of variables:

Name	Alias	Logical Value	Physical Value	Initial Value	Lock	Data
set		<input checked="" type="checkbox"/>	N/A		<input type="checkbox"/>	BOOL
RS_1		...	...	...	<input type="checkbox"/>	RS
reset1		<input type="checkbox"/>	N/A		<input type="checkbox"/>	BOOL
output		<input checked="" type="checkbox"/>	N/A		<input type="checkbox"/>	BOOL

**OR**

Performs a logical OR operation of two or more Boolean values and returns the Boolean value true if either input is true, otherwise returns false.

Languages supported: Function Block Diagram, Ladder Diagram, Structured Text.

This instruction applies to the Micro810, Micro820, Micro830, Micro850, Micro870 controllers and Micro800 Simulator.

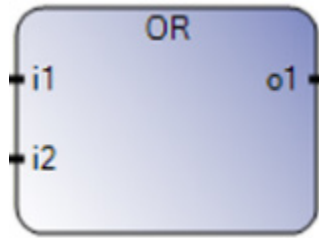

Use this table to help determine the parameter values for this instruction.

Parameter	Parameter Type	Data Type	Description
i1	Input	BOOL	
i2	Input	BOOL	
o1	Output	BOOL	Boolean OR of the input terms. TRUE - When one or more of the inputs are TRUE. FALSE - When inputs are FALSE.

### OR Structured Text example

(\* ST equivalence: \*)

```
bo10 := bi101 OR NOT (bi102);
bo5 := (bi51 OR bi52) OR bi53;
```

## AND

Performs a boolean AND operation between two or more values.

Languages supported: Function Block Diagram, Ladder Diagram, Structured Text.

This instruction applies to the Micro810, Micro820, Micro830, Micro850, Micro870 controllers and Micro800 Simulator.

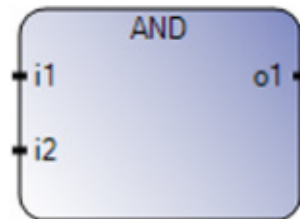

Use this table to help determine the parameter values for this instruction.

Parameter	Parameter Type	Data Type	Description
i1	Input	BOOL	Value in Boolean data type.
i2	Input	BOOL	Value in Boolean data type.
o1	Output	BOOL	Result of the Boolean AND operation of the input values.

## AND Structured Text example

(\* ST equivalence: \*)

```
bo10 := bi101 AND NOT (bi102);
bo5 := (bi51 AND bi52) AND bi53;
```

## XOR (exclusive OR)

Performs an exclusive OR operation of two Boolean values.

Languages supported: Function Block Diagram, Ladder Diagram, Structured Text.

This instruction applies to the Micro810, Micro820, Micro830, Micro850, Micro870 controllers and Micro800 Simulator.

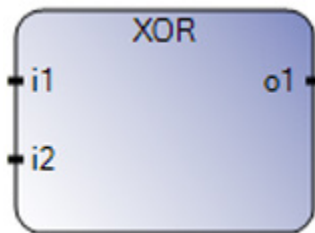

Use this table to help determine the parameter values for this instruction.

Parameter	Parameter Type	Data Type	Description
i1	Input	BOOL	
i2	Input	BOOL	
o1	Output	BOOL	Boolean exclusive OR of the two input terms. TRUE - When either input is TRUE. FALSE - When both inputs are FALSE or both inputs are TRUE.

## XOR Structured Text example

(\* ST equivalence: \*)

```
bo10 := bi101 XOR NOT (bi102);
bo5 := (bi51 XOR bi52) XOR bi53;
```

## NOT

Converts Boolean values to negated values.

Languages supported: Function Block Diagram, Ladder Diagram, Structured Text.

This instruction applies to the Micro810, Micro820, Micro830, Micro850, Micro870 controllers and Micro800 Simulator.



Use this table to help determine the parameter values for this instruction.

Parameter	Parameter Type	Data Type	Description
-----------	----------------	-----------	-------------

i1	Input	BOOL	Any Boolean value or complex expression.
o1	Output	BOOL	TRUE when IN is FALSE. FALSE when IN is TRUE.

### NOT Structured Text example

(\* ST equivalence: \*)

```
bo10 := NOT (bi101);
```

Set a dominant bistable.

Languages supported: Function Block Diagram, Ladder Diagram, Structured Text.

This instruction applies to the Micro810, Micro820, Micro830, Micro850, Micro870 controllers and Micro800 Simulator.

### SR (set/reset)

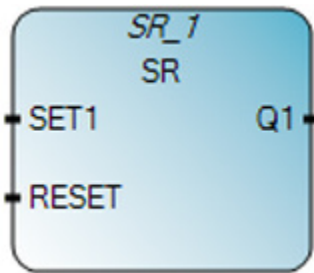

Use this table to help determine the parameter values for this instruction.

Parameter	Parameter Type	Data Type	Description
SET1	Input	BOOL	TRUE - sets Q1 to TRUE (dominant: highest priority when determining instruction behavior).
RESET	Input	BOOL	TRUE - resets Q1 to FALSE.
Q1	Output	BOOL	Boolean memory state. TRUE - when SET1 is TRUE. FALSE - when RESET is TRUE.

### Dominant bistable example

Set1	Reset	Q1	Result Q1
0	0	0	0
0	0	1	1
0	1	0	0
0	1	1	0
1	0	0	1
1	0	1	1
1	1	0	1
1	1	1	1



## SR Function Block Diagram example

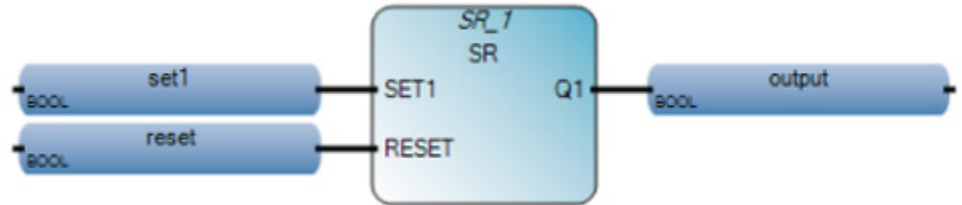

## SR Ladder Diagram example

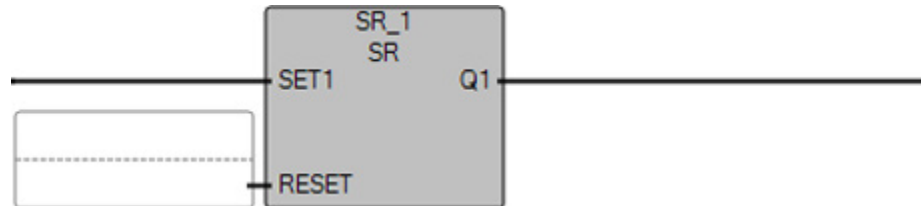

## SR Structured Text example

```
SR_1 {
  void SR_1(BOOL SET1, BOOL RESET)
  Type : SR, Set dominant bistable

1  set1 := TRUE;
2  reset := FALSE;
3  SR_1(set1, reset);
4  output := SR_1.Q1;
```

(\* ST Equivalence: SR1 is an instance of a SR block \*)

```
SR1((auto_mode & start_cmd), stop_cmd);
command := SR1.Q1;
```

## Results

Variable Monitoring window showing the state of variables for the SR\_1 block. The window displays the following table:

Name	Logical Value	Physical Value	Initial Value	Lock	Data Type
SR_1	...	...	...	<input type="checkbox"/>	SR
set1	<input checked="" type="checkbox"/>	N/A		<input type="checkbox"/>	BOOL
reset	<input type="checkbox"/>	N/A		<input type="checkbox"/>	BOOL
output	<input checked="" type="checkbox"/>	N/A		<input type="checkbox"/>	BOOL

## TTABLE (truth table)

Provides the value of the output based on the combination of inputs.

If the value is 0xABCD and In3 through In0 corresponds to the number 7,

then TTABLE is the value of bit 7 in the table (which is 1). The least significant bit in the table is bit 0.

Languages supported: Function Block Diagram, Ladder Diagram, Structured Text.

This instruction applies to the Micro810, Micro820, Micro830, Micro850, Micro870 controllers and Micro800 Simulator.

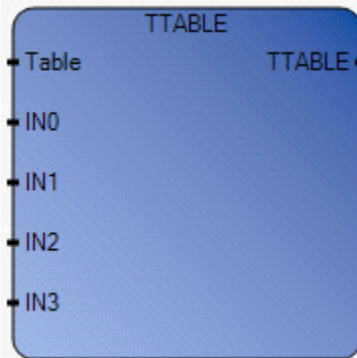

Use this table to help determine the parameter values for this instruction.

Parameter	Parameter Type	Data Type	Description
Table	Input	UINT	Truth table of BOOLEAN function.
IN0	Input	BOOL	Any BOOL input value.
IN1	Input	BOOL	Any BOOL input value.
IN2	Input	BOOL	Any BOOL input value.
IN3	Input	BOOL	Any BOOL input value.
TTABLE	Output	BOOL	The value of the output according to the combination of inputs.

### TTABLE input combinations

The TTABLE instruction has four inputs, and therefore 16 combinations. These combinations are found in a truth table; for each combination, the output value can be adjusted. The number of configurable combinations depends on the number of inputs connected to the function.

Truth Table combination example.

Number	In3	In2	In1	In0
1	0	0	0	0
2	0	0	0	1
3	0	0	1	0
4	0	1	1	1
5	0	1	0	1
6	0	1	1	0
7	0	1	1	1
8	1	0	0	0
9	1	0	0	1
10	1	0	1	0
11	1	0	1	1

12	1	1	0	0
13	1	1	0	1
14	1	1	1	0
15	1	1	1	1

### TTABLE Function Block Diagram diagram

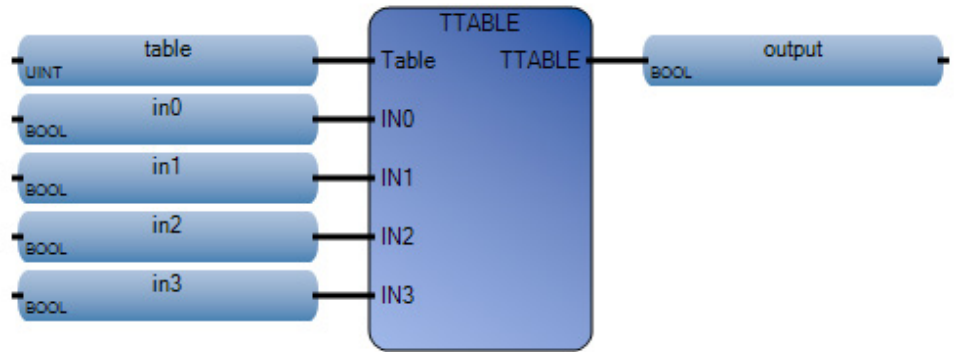

### TTABLE Ladder Diagram example

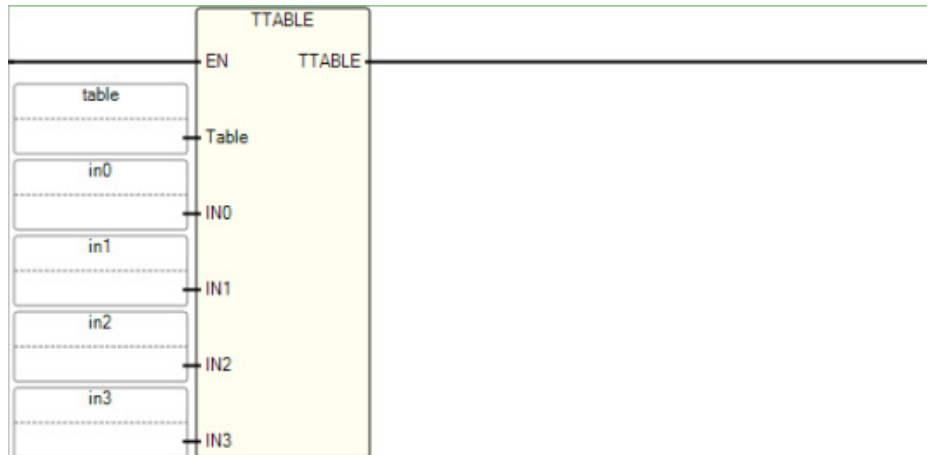

## TTABLE Structured Text example

**TTABLE** (  
 BOOL **TTABLE**(UINT Table, BOOL IN0, BOOL IN1, BOOL IN2, BOOL IN3)  
 Provide the value output based on the combination of inputs.

```

1  table := 217;
2  in0 := TRUE;
3  in1 := TRUE;
4  in2 := TRUE;
5  in3 := FALSE;
6  output := TTABLE(table, in0, in1, in2, in3);
    
```

### Results

Name	Logical Value	Physical Value	Initial Value	Lock	Data Type	Dimension
in0	<input checked="" type="checkbox"/>	N/A		<input type="checkbox"/>	BOOL	
table	217	N/A		<input type="checkbox"/>	UINT	
in1	<input checked="" type="checkbox"/>	N/A		<input type="checkbox"/>	BOOL	
in2	<input checked="" type="checkbox"/>	N/A		<input type="checkbox"/>	BOOL	
in3	<input type="checkbox"/>	N/A		<input type="checkbox"/>	BOOL	
output	<input checked="" type="checkbox"/>	N/A		<input type="checkbox"/>	BOOL	

## MUX8B (multiplexer of 8 BOOL inputs)

Multiplexer between eight BOOL inputs, outputs a BOOL value.

Languages supported: Function Block Diagram, Ladder Diagram, Structured Text.

This instruction applies to the Micro810, Micro820, Micro830, Micro850, Micro870 controllers and Micro800 Simulator.

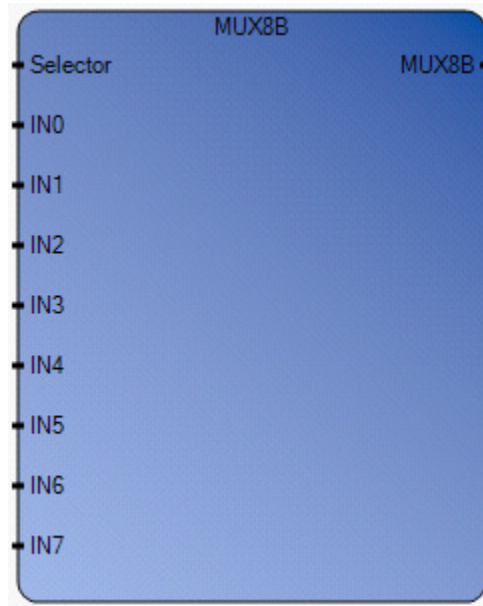

Use this table to help determine the parameter values for this instruction.

Parameter	Parameter Type	Data Type	Description
Selector	Input	USINT	Selector integer value, must be in set [0...7].
IN0	Input	BOOL	Any BOOL input value. TRUE - when Selector is 0. FALSE - when Selector is not 0.
IN1	Input	BOOL	Any BOOL input value. TRUE - when Selector is 1. FALSE - when Selector is not 1.
IN2	Input	BOOL	Any BOOL input value. TRUE - when Selector is 2. FALSE - when Selector is not 2.
IN3	Input	BOOL	Any BOOL input value. TRUE - when Selector is 3. FALSE - when Selector is not 3.
IN4	Input	BOOL	Any BOOL input value. TRUE - when Selector is 4. FALSE - when Selector is not 4.
IN5	Input	BOOL	Any BOOL input value. TRUE - when Selector is 5. FALSE - when Selector is not 5.
IN6	Input	BOOL	Any BOOL input value. TRUE - when Selector is 6. FALSE - when Selector is not 6.
IN7	Input	BOOL	Any BOOL input value. TRUE - when Selector is 7. FALSE - when Selector is not 7.

MUX8B	Output	BOOL	<p>TRUE - when:</p> <ul style="list-style-type: none"> <li>• In0 if Selector = 0</li> <li>• In1 if Selector = 1</li> <li>• In2 if Selector = 2</li> <li>• In3 if Selector = 3</li> <li>• In4 if Selector = 4</li> <li>• In5 if Selector = 5</li> <li>• In6 if Selector = 6</li> <li>• In7 if Selector = 7</li> </ul> <p>FALSE - for all other values of the Selector.</p>
-------	--------	------	---

**MUX8B Function Block Diagram example**

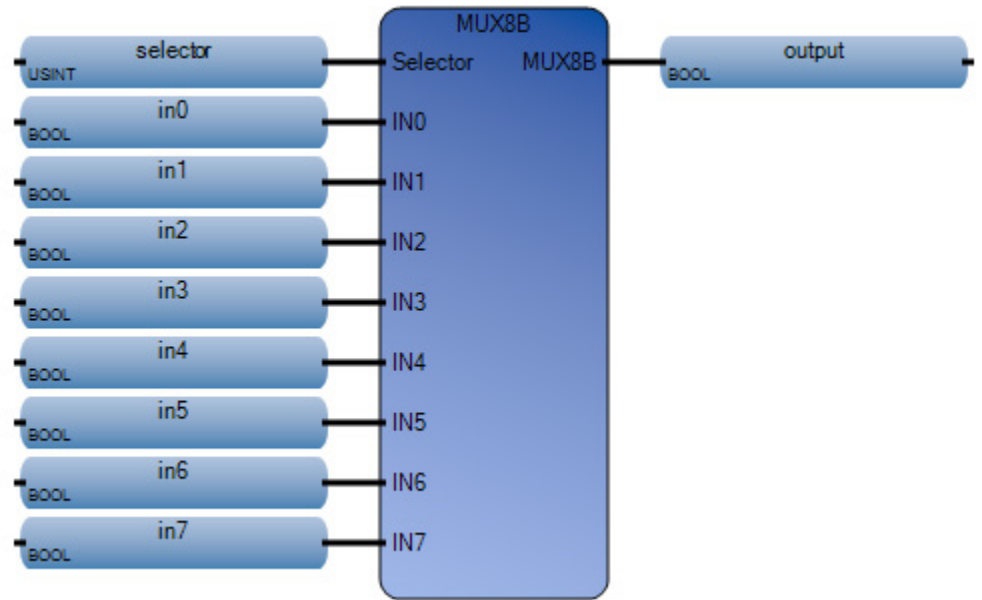

## MUX8B Ladder Diagram example

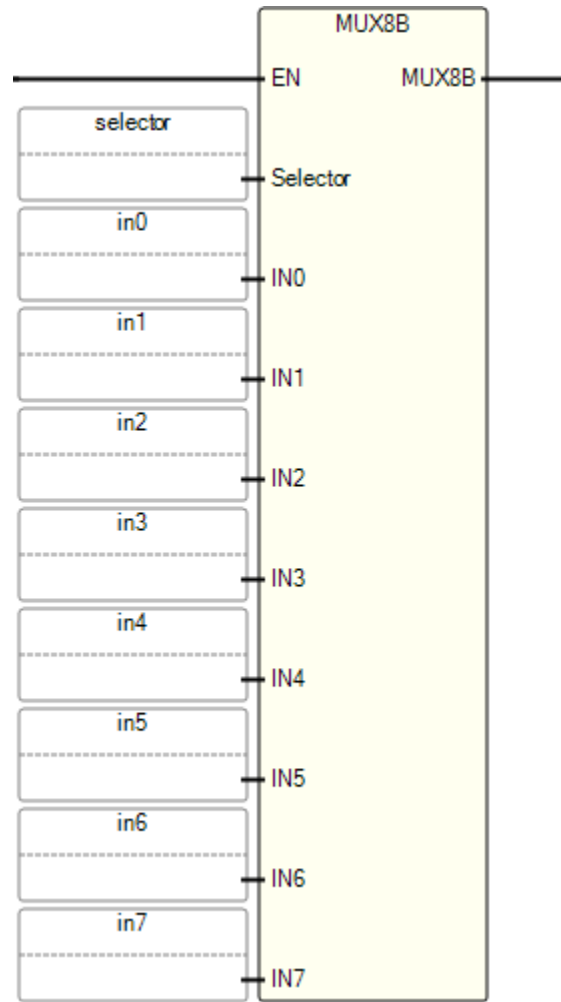

## MUX8B Structured Text example

**MUX8B**

BOOL **MUX8B**(USINT Selector, BOOL IN0, BOOL IN1, BOOL IN2, BOOL IN3, BOOL IN4, BOOL IN5, BOOL IN6, BOOL IN7)  
Multiplexer(8 entries) - accepts BOOL inputs and output value.

```

1 | selector := 7;
2 | in0 := FALSE;
3 | in1 := FALSE;
4 | in2 := FALSE;
5 | in3 := FALSE;
6 | in4 := FALSE;
7 | in5 := FALSE;
8 | in6 := FALSE;
9 | in7 := TRUE;
10| output := MUX8B(selector, in0, in1, in2, in3, in4, in5, in6, in7);

```

(\* ST Equivalence: \*)

range := MUX8 (choice, 1, 5, 10, 50, 100, 500, 1000, 5000);

(\* select from 8 predefined ranges, for example, if choice is 3, range will be 50 \*)

### Results

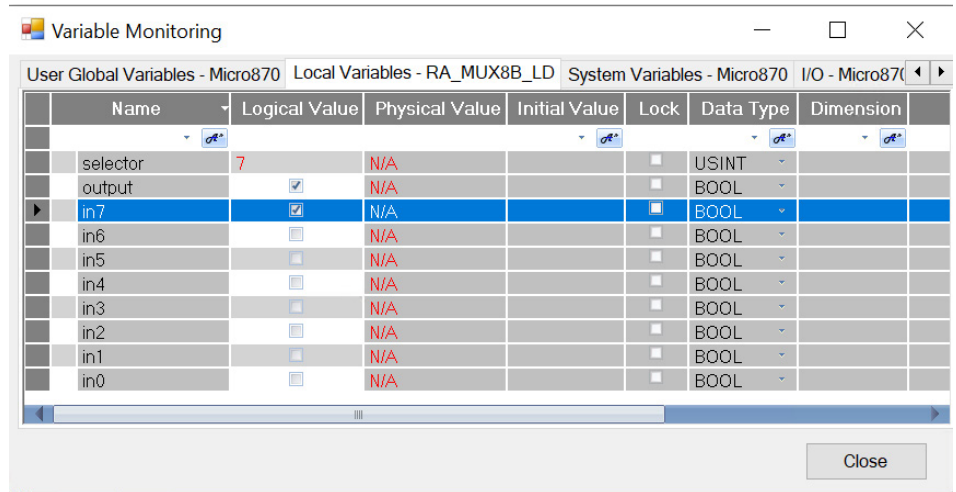

### MUX4B (multiplexer of 4 BOOL inputs)

Multiplexer between four BOOL inputs, outputs a BOOL value.

Languages supported: Function Block Diagram, Ladder Diagram, Structured Text.

This instruction applies to the Micro810, Micro820, Micro830, Micro850, Micro870 controllers and Micro800 Simulator.



Use this table to help determine the parameter values for this instruction.

Parameter	Parameter Type	Data Type	Description
Selector	Input	USINT	Selector integer value, must be in set [0...3].
IN0	Input	BOOL	Any BOOL input value. TRUE - when Selector is 0. FALSE - when Selector is not 0.
IN1	Input	BOOL	Any BOOL input value. TRUE - when Selector is 1. FALSE - when Selector is not 1.



IN2	Input	BOOL	Any BOOL input value. TRUE - when Selector is 2. FALSE - when Selector is not 2.
IN3	Input	BOOL	Any BOOL input value. TRUE - when Selector is 3. FALSE - when Selector is not 3.
MUX4B	Output	BOOL	TRUE - when: <ul style="list-style-type: none"> <li>• In0 if Selector = 0</li> <li>• In1 if Selector = 1</li> <li>• In2 if Selector = 2</li> <li>• In3 if Selector = 3</li> </ul> FALSE - for all other values of the Selector.

### MUX4B Function Block Diagram example

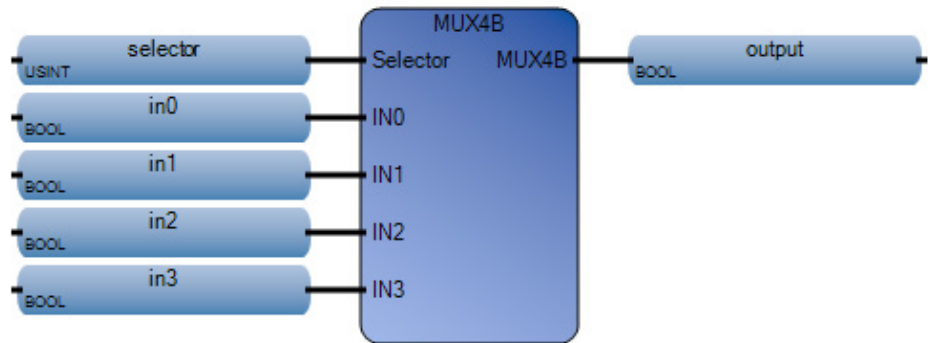

### MUX4B Ladder Diagram example

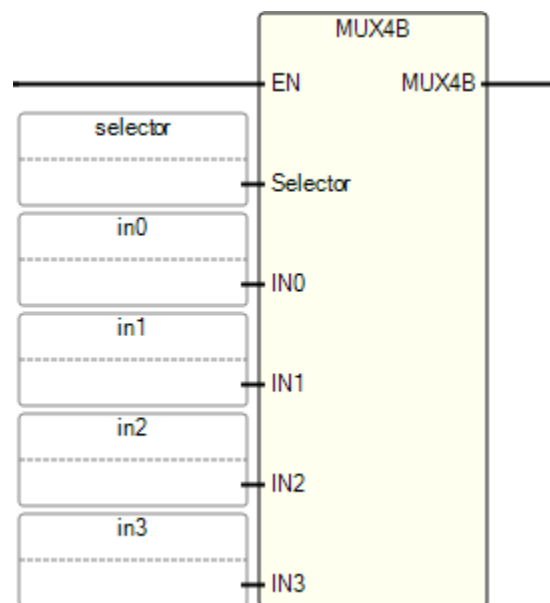

## MUX4B Structured Text example

```
MUX4B (
  BOOL MUX4B(USINT Selector, BOOL IN0, BOOL IN1, BOOL IN2, BOOL IN3)
  Multiplexer(4 entries) - accepts BOOL inputs and output value.
```

```
1 selector := 1;
2 in0 := FALSE;
3 in1 := TRUE;
4 in2 := FALSE;
5 in3 := FALSE;
6 output := MUX4B(selector, in0, in1, in2, in3);
```

(\* ST Equivalence: \*)

range := MUX4(choice, 1, 10, 100, 1000);

(\* select from 4 predefined ranges, for example, if choice is 1, range will be 10 \*)

## Results

The Variable Monitoring window displays the following data:

Name	Logical Value	Physical Value	Initial Value	Lock	Data Type	Dimension
selector	1	N/A		<input type="checkbox"/>	USINT	
output	<input checked="" type="checkbox"/>	N/A		<input type="checkbox"/>	BOOL	
in3	<input type="checkbox"/>	N/A		<input type="checkbox"/>	BOOL	
in2	<input type="checkbox"/>	N/A		<input type="checkbox"/>	BOOL	
in1	<input checked="" type="checkbox"/>	N/A		<input type="checkbox"/>	BOOL	
in0	<input type="checkbox"/>	N/A		<input type="checkbox"/>	BOOL	

## Communication instructions

Use Communication instructions to read, write, compare, and convert communication strings.

Function block	Description
<a href="#">COM_IO_WDOG</a> on <a href="#">page 163</a>	Monitors communications to the controller.
<a href="#">MSG_CIPGENERIC</a> on <a href="#">page 165</a>	Sends a CIP generic explicit message.
<a href="#">MSG_CIPSYMBOLIC</a> on <a href="#">page 173</a>	Sends a CIP symbolic explicit message.
<a href="#">MSG_MODBUS</a> on <a href="#">page 177</a>	Sends a Modbus message.
<a href="#">MSG_MODBUS2</a> on <a href="#">page 182</a>	Sends a MODBUS/TCP message over an Ethernet Channel.
<a href="#">MSG_PCCC</a> on <a href="#">page 188</a>	Sends a PCCC message over an Ethernet channel or a serial port.

### COM\_IO\_WDOG

Monitors external messaging to controller inputs and outputs. For example, if CIP write command to variable `_IO_EM_DO_oo` is not received over EtherNet/IP within the configured timeout, the watch dog timer will expire and all controller outputs are reset.

EtherNet/IP, Modbus TCP, and Modbus RTU protocols are supported.

Languages supported: Function Block Diagram, Ladder Diagram, Structured Text.

This instruction applies to the Micro820, Micro830, Micro850, Micro870 controllers and Micro800 Simulator. It is only supported with firmware version 12.00 and later.



Note:

- Although multiple instances of this instruction can exist, only one instance can be enabled. Otherwise, an error will occur with ErrorID set to 2.
- Only controller embedded, plug-in, and expansion digital I/O are supported.

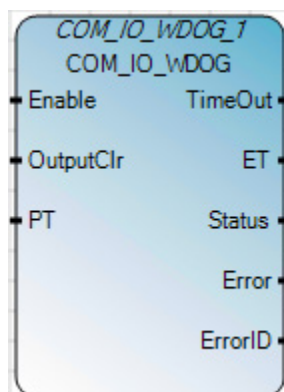

Use this table to help determine the parameter values for this instruction.

<b>Parameter</b>	<b>Parameter Type</b>	<b>Data Type</b>	<b>Description</b>
Enable	Input	BOOL	<p>TRUE - These are the three cases of the TRUE condition.</p> <ol style="list-style-type: none"> <li>On rising edge of TRUE, the function block starts to execute. Status bit is set to 0 and the rest of the bits are cleared. Then verify the below error conditions. If no errors occur, proceeds to the next step. <ul style="list-style-type: none"> <li>If PresetValue is less than one second, Error is set to TRUE and ErrorID is set to 1, Status bit 4 is set, TimeOut and ElapsedTime are cleared.</li> <li>If the timer is already acquired by the other instance, Error is set to TRUE and ErrorID is set to 2, Status bit 4 is set, TimeOut and ElapsedTime are cleared.</li> </ul> </li> <li>PresetTime &gt; ElapseTime. When Enable is set to TRUE and the function block starts to execute. Check if any commands are received. If any commands are received, reset the timer immediately. Set ElapsedTime to 0 and set Status bit 2. The rest of the bits are cleared. If no commands are received, set Status bit 1 and the rest of the bits are cleared.</li> <li>PresetTime = ElapsedTime. When Enable is set to TRUE and the function block starts to execute. Check if any commands are received. If received, reset the timer immediately. Set ElapsedTime to 0 and set the Status bit 2. The rest of the bits are cleared. Else set the TimeOut bit, set the Status bit 3 and the rest of the bits are cleared. Set the internal variable to clear the digital outputs at the end of the scan if the configured action is to clear all the digital outputs at the end of the scan.</li> </ol> <p>FALSE - the instruction does not execute and function block outputs are cleared.</p>
OutputClr	Input	BOOL	<p>0 - Do nothing if timeout occurs.</p> <p>1 - Clear all the digital outputs at the end of the scan (Embedded, EXIO and UPM) if timeout occurs.</p>
PT	Input	TIME	<p>Duration to wait before timeout.</p> <p>The value for a timeout cannot be less than one second, or an error occurs. The maximum value for PresetTime can be the maximum value within TIME data type.</p>
TimeOut	Output	BOOL	<p>TRUE - ElapsedTime equals to PresetTime.</p> <p>FALSE - Enable is set to FALSE; the timer is not elapsed or an error occurred.</p>
ET	Output	TIME	<p>The current elapsed time.</p> <p>The possible values range is from 0 ms to 1193h2m47s294ms.</p>
Status	Output	USINT	<p>Status of the function block.</p> <p>Bit 0 - Enable</p> <p>Bit 1 - Timer is running, no output or input has been received.</p> <p>Bit 2 - The output or input command has been received.</p> <p>Bit 3 - Timeout occurred. No output or input command has been received.</p> <p>Bit 4 - Error occurred.</p> <p>Other bits are reserved.</p>
Error	Output	BOOL	Indicates an error occurred.
ErrorID	Output	USINT	When an error occurs, ErrorID contains the error code.

### **COM\_IO\_WDOG error code**

<b>ErrorID Code</b>	<b>Error description</b>
1	The PresetTime is less than one second.
2	Another COM_IO_WDOG function block instance is already executing.

### COM\_IO\_WDOG Function Block Diagram example

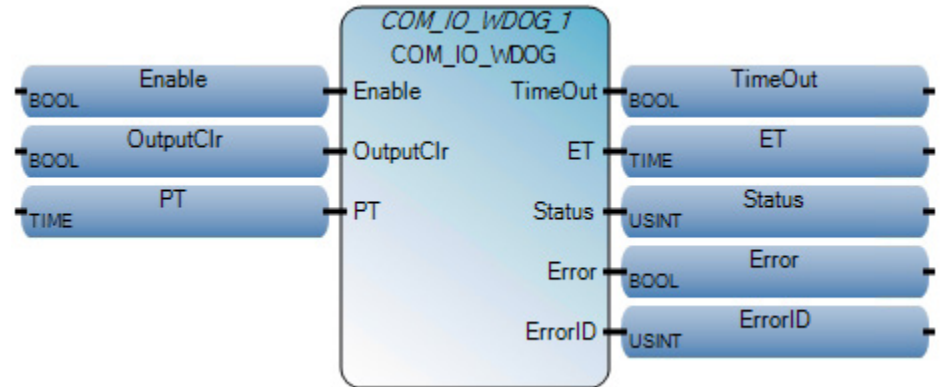

### COM\_IO\_WDOG Ladder Diagram example

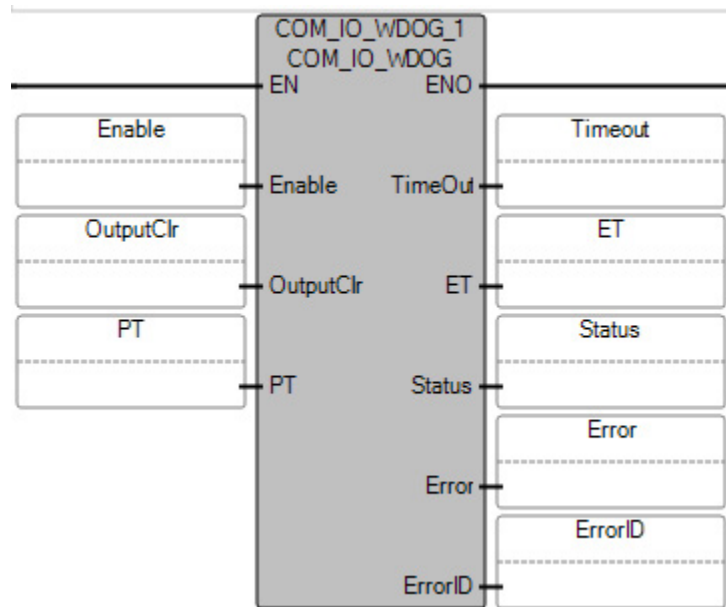

### COM\_IO\_WDOG Structured Text example

```

COM_IO_WDOG_1 void COM_IO_WDOG_1(BOOL Enable, BOOL OutputClr, TIME PT)
Type: COM_IO_WDOG, COM_IO_WDOG allows user to monitor communications to the controller

1 COM_IO_WDOG_1(Enable, OutputClr, PT);
2 Timeout :=COM_IO_WDOG_1.Timeout;
3 ET :=COM_IO_WDOG_1.ET;
4 Status :=COM_IO_WDOG_1.Status;
5 Error :=COM_IO_WDOG_1.Error;
6 ErrorID :=COM_IO_WDOG_1.ErrorID;
    
```

### MSG\_CIPGENERIC (common industrial protocol generic message)

Sends a common industrial protocol (CIP) explicit message over an Ethernet channel or a serial port.

A maximum of four message requests per channel can be processed in one scan. For Ladder Diagram programs, message requests are executed at the

end of a ladder scan.

Languages supported: Function Block Diagram, Ladder Diagram, Structured Text.

This instruction applies to the Micro820, Micro830, Micro850, Micro870 controllers and Micro800 Simulator.

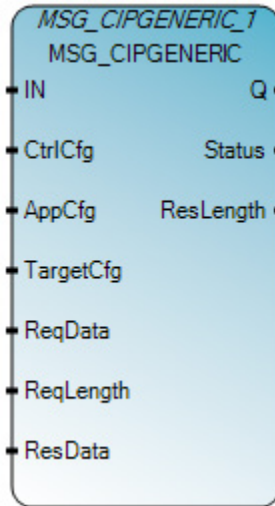

Use this table to help determine the parameter values for this instruction.

Parameter	Parameter Type	Data Type	Description
IN	Input	BOOL	Rung input state. TRUE - Rising Edge detected, start the instruction block with the precondition that the last operation has been completed. FALSE - Rising Edge not detected, idle.
CtrlCfg	Input	CIPCONTROLCFG	The instruction block execution control configuration. Use the <a href="#">CIPCONTROLCFG data type</a> on <a href="#">page 168</a> parameters to define CtrlCfg.
AppCfg	Input	CIPAPPCFG	CIP service and application path (EPATH) configuration. Use the <a href="#">CIPAPPCFG data type</a> on <a href="#">page 167</a> parameters to define AppCfg.
TargetCfg	Input	CIPTARGETCFG	Target device configuration. Use the <a href="#">CIPTARGETCFG data type</a> on <a href="#">page 171</a> parameters to define TargetCfg.
ReqData	Input	USINT[1..1]	CIP message request data. The array size should be greater than the ReqLength size.
ReqLength	Input	UINT	CIP message request data length: • 0 - 490
ResData	Input	USINT[1..1]	CIP message response data. The array size should be greater than the ReqLength size. When a MSG is triggered or re-triggered, data in the ResData array is cleared.
Q	Output	BOOL	Outputs of this instruction are updated asynchronously from the program scan. Output Q cannot be used to re-trigger the instruction since IN is edge triggered. TRUE - MSG instruction finished successfully. FALSE - MSG instruction is not finished.
Status	Output	CIPSTATUS	The instruction block status. When a MSG is triggered, or re-triggered, all elements inside Status are reset. The Status output is defined in <a href="#">CIPSTATUS data type</a> on <a href="#">page 169</a> .
ResLength	Output	UINT	CIP message response data length: • 0 - 490 When a MSG is triggered, or re-triggered, ResLength is reset to 0.

### MSG\_CIPGENERIC Function Block Diagram example

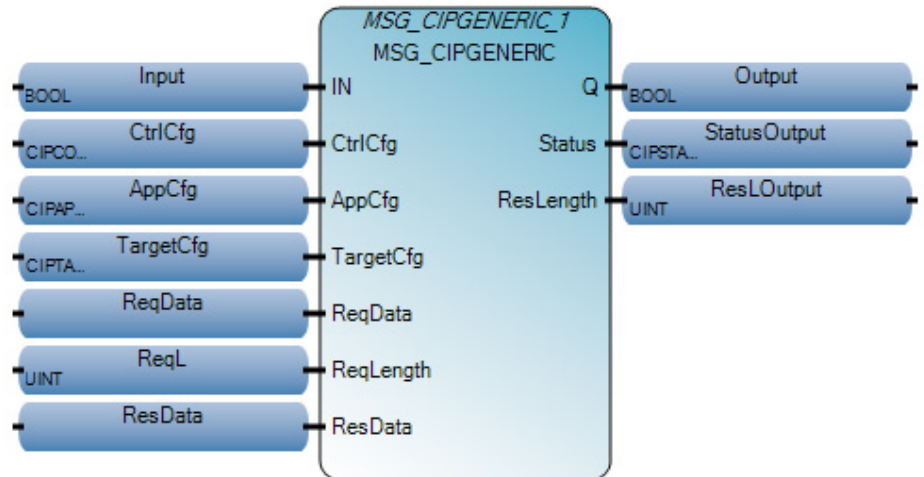

### MSG\_CIPGENERIC Ladder Diagram example

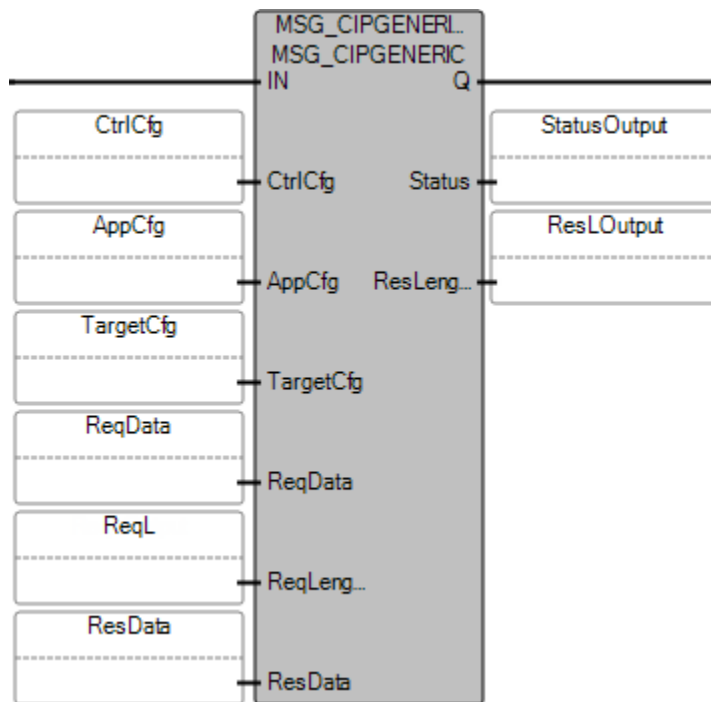

### MSG\_CIPGENERIC Structured Text example

```

1 MSG_CIPGENERIC_1(in1, CtrlCf, app1, target1, request1, length1, data1);
2 out1 := MSG_CIPGENERIC_1.Q;
3 status1 := MSG_CIPGENERIC_1.Status;
4 resLength1 := MSG_CIPGENERIC_1.ResLength;
5
6 MSG_CIPGENERIC_2 |
void MSG_CIPGENERIC_2(BOOL IN, CIPCONTROLCFG CtrlCfg, CIPAPPCFG AppCfg, CIPTARGETCFG TargetCfg, USINT[1..1] ReqData, USINT ReqLength, USINT[1..1] ResData)
Type: MSG_CIPGENERIC, Send a CIP explicit message.

```

### CIPAPPCFG data type

Use this table to help define the parameters for the CIPAPPCFG data type.

Parameter	Data type	Description
-----------	-----------	-------------

Parameter	Data type	Description
Service	USINT	Service code: 1 - 127
Class	UINT	Logical segment's Class ID value: 1 - 65535
Instance	UDINT	Logical segment's Instance ID value: 0 - 4294967295
Attribute	UINT	Logical segment's Attribute ID value: 1 - 65535, 0 - No Attribute ID used
MemberCnt	USINT	Members ID count. Maximum Member ID values used: 1 - 3, 0 - No Member ID used
MemberId	UINT[3]	Member ID values: 0 - 65535

### CIPCONTROLCFG data type

Use this table to help determine the parameter values for the CIPCONTROLCFG data type.

Parameter	Data Type	Description
Cancel	BOOL	TRUE - Cancel the execution of the function block. Bit is cleared when the message is enabled. If the Cancel parameter is set, and the message is enabled (EN bit is set) and not done (DN bit is not set), then the message execution is cancelled and the ER bit is set.
TriggerType	USINT	Represents one of the following: <ul style="list-style-type: none"> <li>• 0: Msg Triggered Once (when IN goes from False to True)</li> <li>• 1 to 65535: Cyclic trigger value in milliseconds. Msg is triggered periodically when IN is True. Set the value to 1 to trigger the MSG as quickly as possible.</li> </ul>
StrMode	USINT	Reserved for future use.

### CIP message triggering

A CIP message can be triggered periodically by setting a non-zero value to the TriggerType parameter.

Use this table to help define the actions for the TriggerType parameter.

Action	Results
Message is enabled	Trigger timer starts
Trigger timer expires before the message completes	Message is immediately triggered in the next ladder scan cycle.
Message completes before the trigger time expires	Message is triggered when the trigger time expires.



### Example: message triggering

In the following example, the TriggerType value is set to 100.

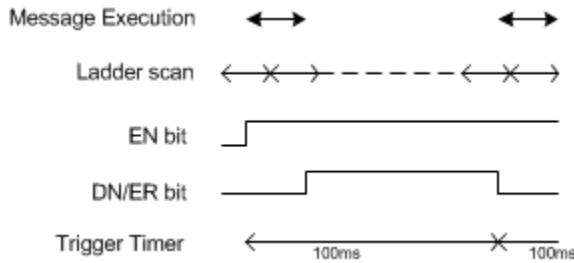

### CIPSTATUS data type

Use this table to help determine the parameter values for the CIPSTATUS data type.

Parameter	Data type	Description
Error	BOOL	This bit is set to TRUE when the function block execution encounters an error condition.
ErrorID	UINT	Error code value. ErrorIDs are defined in <a href="#">CIPSTATUS error codes</a> on <a href="#">page 170</a> .
SubErrorID	UINT	Sub Error code value. SubErrorIDs defined in CIPSTATUS error codes.
ExtErrorID	UINT	CIP extended status error code value.
StatusBits	UINT	This parameter can be used to verify control bits: <ul style="list-style-type: none"> <li>• Bit 0: EN – Enable</li> <li>• Bit 1: EW – Enable Wait</li> <li>• Bit 2: ST – Start</li> <li>• Bit 3: ER – Error</li> <li>• Bit 4: DN – Done</li> <li>• Bit 5: CIPCONN – CIP Connection Closure</li> <li>• Bit 6: EIPSESS – EIP Session Closure</li> <li>• Other bits are reserved</li> </ul> StatusBits are defined for <a href="#">CIPSTATUS status bits</a> on <a href="#">page 169</a> .

### CIPSTATUS status bits

The CIPSTATUS status bits are set based on the status of the message execution, the communication buffers, and the rung conditions.

-	-	-	-	-	-	-	-	-	-	-	4	3	2	1	0
---	---	---	---	---	---	---	---	---	---	---	---	---	---	---	---

Bit	Name	Description	Behavior
0	EN	Enable	Set when the rung goes true and remains set until either the DN bit or the ER bit is set and the rung goes false.
1	EW	Enable Waiting	Set when the communication buffer is allocated for the message request. Cleared when the ST bit is set.
2	ST	Start	Set when the message has been transmitted and is waiting for a reply. Cleared when the DN bit is set.
3	ER	Error	Set when message transmission fails. An error code is written to ErrorID. The ER bit and error code values are cleared the next time the rung goes from false to true.
4	DN	Done	Set when the message is transmitted successfully. The DN bit is cleared the next time the rung goes from false to true. When the Done bit is set, all other bits are cleared to indicate the MSG completed successfully. When an error is detected and the Error bit is set, the other status bits (EN/EW/ST) are not cleared.

Bit	Name	Description	Behavior
5	CIPCONN	Done	Set when the CIP Connection for the Communication is closed. The CIPCONN bit is applicable when ConnClose is True, for other cases the CIPCONN bit is False. The CIPCONN bit is also used for Serial, Ethernet and USB.
6	EIPSESS	Done	Set when the Encapsulation CIP Session for the Communication is closed. The EIPSESS bit is applicable when ConnClose is True, for other cases the EIPSESS bit is False. This bit is used for Ethernet only.

## CIPSTATUS error codes

Use this table to help determine the parameter values for the ErrorID and SubErrorID fields of the CIPSTATUS parameter when the ER bit is set.

ErrorID code	SubErrorID	Error code description
33		Parameter configuration related errors
	32	Bad Channel number.
	36	Unsupported CIP connection type.
	40	Unsupported CIP symbolic data type.
	41	Invalid CIP symbol name.
	43	Unsupported CIP Class value or MemberID count.
	48	The instruction block's input data array size is not sufficient.
	49	Invalid target path.
	50	Bad service code.
	51	The instruction block's transmit data array size is too big for CIP communication. The maximum length for the user data to be transmitted varies for different message configurations. If the total CIP message payload (including user data and CIP message overhead) is beyond 504 bytes, an error 0x21 (subError 0x33) is reported.
	52	Bad Segment type value.
	53	Bad UCCM timeout value. If the encapsulation timeout value is less than the UCCM timeout or the difference between encapsulation timeout and UCCM time out is less than or equal to one second, an error 0x21 (subError 0x35) is reported.
	54	Bad connected timeout value. If the encapsulation timeout value is less than the CONNECTED message timeout or the difference between the encapsulation timeout and the CONNECTED message time out is less than or equal to one second, an error 0x21 (subError 0x36) is reported.
55		Timeout related errors
	112	Message timed out while waiting in the message wait queue.
	113	Message timed out while waiting for the connection to the link layer to be established.
	114	Message timed out while waiting to transmit to the link layer.
	115	Message timed out while waiting for a response from the link layer.
69		Server response format related error codes
	65	Message reply does not match request.
	68	Message reply data type not valid/supported. (MSG_CIPSYMBOLIC).
208		No IP address configured for the network.
209		Maximum number of connections used - no connections available.
210		Invalid internet address or node address.
217		Message execution was canceled by user. (Cancel parameter was set to TRUE).
218		No network buffer space available.
222		Reserved.
223		The Link address is not available. A TCP/IP or Ethernet configuration change is in progress.

ErrorID code	SubErrorID	Error code description
224		CIP response error code. SubErrorID specifies the CIP status and ExtErrorID specifies the CIP extended status value. Refer to the CIP specification for possible error code values.
255		Channel is shutdown or reconfiguration is in progress. Error code occurs immediately after power on until a connection is established, and is normal behavior. It may also occur in one of the following situations: <ul style="list-style-type: none"> <li>• An Ethernet cable is disconnected</li> <li>• An IP address cannot be detected</li> <li>• A serial port plug-in is present but not configured</li> </ul>

### CIPTARGETCFG data type

Use this table to help determine the parameter values for the CIPTARGETCFG data type.

Parameter	Data type	Description
Path	STRING[80]	Path for the target. A maximum of two hops can be specified. The path syntax is: <ul style="list-style-type: none"> <li>• {"&lt;port&gt;,&lt;node/slot address&gt;"}2</li> </ul>
CipConnMode	USINT	CIP Connection type. <ul style="list-style-type: none"> <li>• 0 - Unconnected (default)</li> <li>• 1 - Class3 connection</li> </ul>
UcmmTimeout	UDINT	Unconnected message timeout (in milliseconds). The amount of time to wait for a reply for unconnected messages, including connection establishment for connected message. <ul style="list-style-type: none"> <li>• Valid values: 250-10,000 ms.</li> <li>• Set to 0 to use the default value of 3000 ms (3 seconds).</li> <li>• A value set to less than 250 ms will be set to 250 ms (minimum).</li> <li>• A value set to greater than 10,000 ms will be set to 10,000 ms (maximum).</li> </ul>
ConnMsgTimeout	UDINT	Class3 Connection timeout (in milliseconds). The amount of time to wait for a reply for connected messages. The connection closes when the timeout expires. <ul style="list-style-type: none"> <li>• Valid values: 800-10,000 ms.</li> <li>• Set to 0 to use the default value of 10,000 ms (10 seconds).</li> <li>• A value set to less than 800 will be set to 800 ms (minimum).</li> <li>• A value set to greater than 10,000 ms will be set to 10,000 ms (maximum).</li> </ul>
ConnClose	BOOL	Connection closing behavior: <ul style="list-style-type: none"> <li>• TRUE - Close the connection when the message completes.</li> <li>• FALSE - Do not close the connection when the message completed (default).</li> </ul>

### Target path for CIP messaging

The target path for CIP messaging contains parameters which determine the path and destination of the of the CIP message.

The target path string parameter uses the following syntax:

- "<local port>, <1st target's address>, [<1st target's local port>, <2nd target's address>"]

The 1st hop must be present; the 2nd hop is optional.

String element	Description
----------------	-------------

Local port	Local port used to send out the message. The port should be an active EtherNet/IP or CIP Serial port - USB ports are not supported.
1st Target address	Target address of the 1st hop. <ul style="list-style-type: none"> <li>For EIP, specify the target's IP address. The IP address should be a unicast address and should not be 0, multicast, broadcast, local address or a loop back (127.x.x.x) address.</li> <li>For CIP Serial, specify the target's node address. The supported value is 1.</li> </ul>
Local port of the 1st Target	Local port used to send out the message.
2nd Target address	Target address of the 2nd hop.

### Target path example

The following table lists example values used in a target path string and describes the results for each string.

String element	Description
"0,0"	The target device is the local device.
"6,1"	Through Port 6 (Micro830 UPM Serial port) reach the Node at 1.
"4,192.168.1.100"	Through Port 4 (Micro850 embedded Ethernet port) reach the Node at 192.168.1.100.
"4,192.168.1.100,1,0"	Through Port 4 (Micro850 embedded Ethernet port) reach the Node at 192.168.0.100 (Logix ENET module). From ENET module, through the Backplane port (Port 1) reach the Logix controller at Slot 0.

### CIP/EIP message connections

A maximum of 16 CIP (class 3) and 16 EIP connections are supported for client message execution. The following table describes the CIP/EIP connection behavior.

Scenario	Results
Message request is enabled and CipConnMode=1.	If a connection to the target does not exist, a CIP connection is established. If a connection to the target already exists, the existing CIP connection is used.
Message request is enabled, CipConnMode=1, and the message's local port is Ethernet.	If an EIP connection to the target does not exist, an EIP connection is established prior to establishing a CIP connection.
Message request is enabled, CipConnMode=0, and the message's local port is Ethernet.	If an EIP connection to the target does not exist, an EIP connection is established.
Message execution is completed, and ConnClose is set to True.	If there is only one connection to the target, the connection is closed. If there is more than one connection to the target, the connection is closed when the last message execution is completed. When a CIP connection is closed, any associated EIP connection is also closed. If more than one CIP connection uses the same EIP connection, the EIP connection will be closed after all associated CIP connections are closed.
When ConnClose is true, the message connection and EIP Session are closed upon completion of the message execution.	If more than one message shares the same connection then the connection is closed upon completion of the last message.
A CIP or EIP connection that is not associated with any active message is closed if it is idle for x seconds. Where x is a configurable Encapsulation Inactivity Timeout value that can be set using the CIP Set Service.	See CIP Specification Volume II TCP/IP objects for details regarding the CIP Set Service.

Scenario	Results
Message execution is completed, and ConnClose is set to False.	The connection is not closed.
Connection is not associated with an active message and remains idle for the amount of time specified in ConnTimeOut parameter.	The connection is closed.
Controller transitions from an executing mode (Run, Remote Run, Remote Test Single Scan and Remote Single Rung) to a non-executing mode.	All active connections are forcibly closed.

**CIP message timeout timers** The following table describes how timers for CIPTARGETCFG timeout parameters (UcmmTimeout and ConnMsgTimeout) behave based on message requests and status.

Action	Results
Message is enabled	UcmmTimeout timer is activated
Connection is requested	ConnMsgTimeout timer is activated
ConnMsgTimeout timer is active	UcmmTimeout timer is disabled
Connection request is completed	UcmmTimeout timer is reactivated

**MSG\_CIPSYMBOLIC (common industrial protocol symbolic message)**

Sends a common industrial protocol (CIP) symbolic message over an Ethernet channel or a serial port.

Languages supported: Function Block Diagram, Ladder Diagram, Structured Text.

This instruction applies to the Micro820, Micro830, Micro850, Micro870 controllers and Micro800 Simulator.

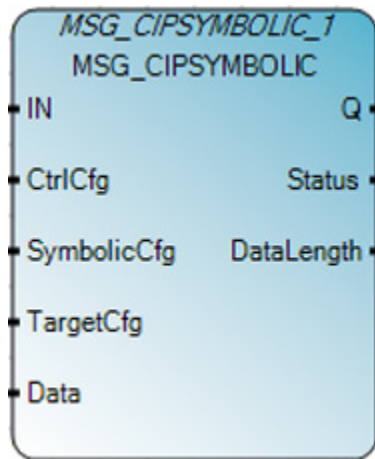

**MSG\_CIPSYMBOLIC operation**

When the function block is enabled, the receive buffers for the Read operations are cleared on the rising edge of Enable.

### Arguments

Parameter	Parameter Type	Data Type	Description
IN	Input	BOOL	Rung input state. TRUE - Rising Edge detected, start the instruction block with the precondition that the last operation has been completed. FALSE - Rising Edge not detected, idle.
CtrlCfg	Input	CIPCONTROLCFG	The instruction block execution control configuration. Use the <a href="#">CIPCONTROLCFG data type</a> on <a href="#">page 168</a> parameters to define CtrlCfg.
SymbolicCfg	Input	<a href="#">CIPSYMBOLICCFG</a> on <a href="#">page 175</a>	Information for the symbol for Read and Write.
TargetCfg	Input	CIPTARGETCFG	Target device configuration. Use the <a href="#">CIPTARGETCFG data type</a> on <a href="#">page 171</a> parameters to define TargetCfg.
Data	Input	USINT[490]	Read command stores the data returned from the server. Write command buffers the data to be sent to the server. When an MSG is triggered or re-triggered, Data is cleared for the MSG Read command.
Q	Output	BOOL	Outputs of this instruction are updated asynchronously from the program scan. Output Q cannot be used to re-trigger the instruction since IN is edge triggered. TRUE - MSG instruction finished successfully. FALSE - MSG instruction is not finished.
Status	Output	CIPSTATUS	Function block execution status When an MSG is triggered, or re-triggered, all elements inside Status are reset. The Status output is defined in <a href="#">CIPSTATUS data type</a> on <a href="#">page 169</a> .
DataLength	Output	UDINT	Number of data bytes for Read service. For Write service, it's 0. When an MSG is triggered or re-triggered, DataLength is reset to 0 for MSG Read command.

### MSG\_CIPSYMBOLIC Function Block Diagram example

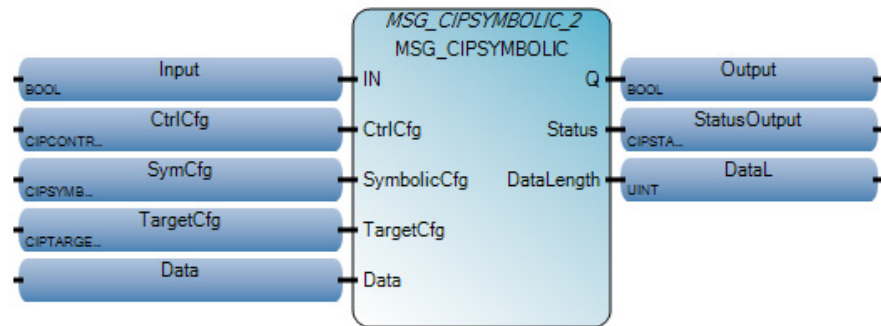

### MSG\_CIPSYMBOLIC Ladder Diagram example

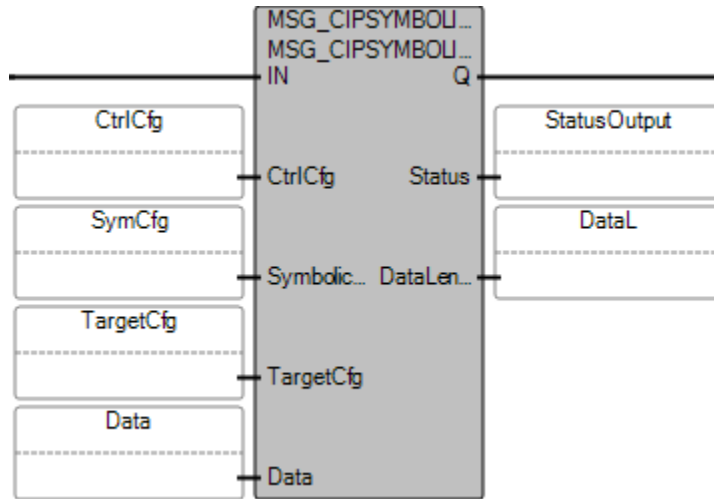

### MSG\_CIPSYMBOLIC Structured Text example

```

1 MSG_CIPSYMBOLIC_1(in1, Ctrl1, symbol1, target1, data1);
2 out1 := MSG_CIPGENERIC_1.Q;
3 status1 := MSG_CIPGENERIC_1.Status;
4 reslen1 := MSG_CIPGENERIC_1.ResLength;
5
6 MSG_CIPSYMBOLIC_2(
    void MSG_CIPSYMBOLIC_2(BOOL IN, CIPCONTROLCFG CtrlCfg, CIPSYMBOLICCFG SymbolicCfg, CIPTARGETCFG TargetCfg, USINT[1..1] Data)
    Type: MSG_CIPSYMBOLIC, Send a CIP Symbolic message.

```

### CIPSYMBOLICCFG data type

Use this table to help determine the parameter values for the CIPSYMBOLICCFG data type.

Parameter	Data type	Description
Service	USINT	Service code: <ul style="list-style-type: none"> <li>• 0 - Read (default)</li> <li>• 1 - Write</li> </ul>
Symbol	STRING	Name of the variable to Read/Write. <ul style="list-style-type: none"> <li>• Maximum of 80 characters.</li> <li>• Field cannot be empty.</li> </ul> Symbol syntax defined in <a href="#">Symbolic Read/Write syntax</a> on <a href="#">page 176</a> .
Count	UINT	Number of variable elements to Read/Write: <ul style="list-style-type: none"> <li>• Valid values: 1 - 490</li> <li>• 1 is used if the value is set to 0.</li> </ul>
Type	User-defined	User-defined data type for the target variable. Type defined in Symbolic data type support.
Offset	USINT	Reserved for future use. A byte offset of Read/Write variable used to Read/Write a large size variable that cannot be processed in one message. <ul style="list-style-type: none"> <li>• 0 - 0xFF</li> </ul>
Reserved for future use.		

### Symbolic data type support

Use this table to help determine the data types MSG\_CIPSYMBOLIC supports.

Data type	Data type value (hexadecimal)	Description
BOOL	193 (0xC1)	Logical Boolean with values TRUE (1) and FALSE (0)
SINT	194 (0xC2)	Signed 8-bit integer value
INT	195 (0xC3)	Signed 16-bit integer value
DINT	196 (0xC4)	Signed 32-bit integer value
LINT	197 (0xC5)	Signed 64-bit integer value
USINT	198 (0xC6)	Unsigned 8-bit integer value
UINT	199 (0xC7)	Unsigned 16-bit integer value
UDINT	200 (0xC8)	Unsigned 32-bit integer value
ULINT	201 (0xC9)	Unsigned 64-bit integer value
REAL	202 (0xCA)	32-bit floating point value
LREAL	203 (0xCB)	64-bit floating point value
STRING	218 (0xDA)	Character string

## Symbolic Read/Write syntax

Syntax defines the combinations of symbols of a valid read/write instruction block.

### Valid symbol names

To be valid, each symbol name must meet the following requirements.

- Begin with a letter or underscore character followed by a letter, digit, or single underscore character.
- Be 40 characters or less.
- Not contain two consecutive underscore characters.
- Use special characters [ ] . , as separators.

### Symbol syntax

Use this table to help define the valid syntax for symbols. Only global variables are supported.

Symbol	Syntax	Example
Variable	PROGRAM:<program name>,<symbol name>	PROGRAM:POU1.MyTag
Array	<symbol name>[dim3, dim2, dim1] (Maximum supported dimension is 3.	MyTag[0] MyTag[3,6] MyTag3[1,0,4]
Structure	<symbol name>.<symbol name of struct field>	MyTag4.time.year MyTag5.local.time[1].year

## Supported Data Packet Size for CIP Serial Function

For Micro830, Micro850 and Micro870 controllers, both embedded serial port and plug-in serial ports can support CIP serial communication. CIP serial communication data packet includes user data and CIP packet header.



When working as a CIP serial client, Micro830/Micro850 serial ports can support a maximum of 490 bytes of read/write user data. This maximum specification applies to CIP serial data packets with a minimum packet header size. When the size of a packet header is bigger than the minimum packet header size, the maximum size of user data that the CIP client can support is less than 490 bytes. If data packet size is greater than the maximum data size supported by the CIP client, the function block reports an error (0x21) and a sub-error (0x33).

When working as a CIP serial server, Micro830, Micro850 and Micro870 serial ports can support a minimum of 255 bytes of read/write user data. This minimum user data size specification applies to CIP serial data packets with maximum packet header size. When the size of CIP packet header is less than the maximum packet header size, the CIP client can support data packet size that is greater than the minimum specification (that is, greater than 255 bytes). However, if user data size is greater than the maximum data size supported by the CIP server function, the CIP data packet could be dropped, and the client will time out.

---

**IMPORTANT** For CIP serial server function, it is recommended not to read/write more than 255 bytes of user data in a single CIP message.

---

## MSG\_MODBUS (modbus message)

Sends a Modbus message over a serial port.

Operation details:

- A maximum of four message requests per channel can be processed in one scan. For Ladder Diagram programs, message requests are executed at the end of a ladder scan.
- If a trigger is set to continuous, error codes are also continuously cleared. To view error codes, add a rung before the MSG\_MODBUS instruction.

Languages supported: Function Block Diagram, Ladder Diagram, Structured Text.

This instruction applies to the Micro820, Micro830, Micro850, and Micro870 controllers.

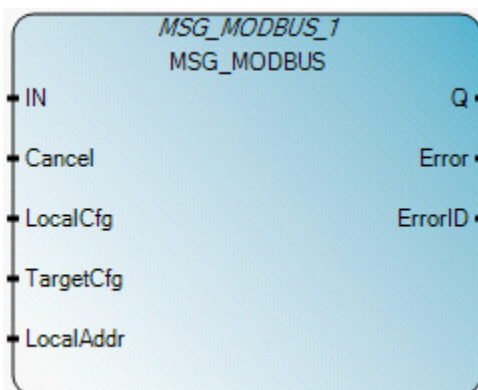

Use this table to help determine the parameter values for this instruction.

Parameter	Parameter Type	Data Type	Description
IN	Input	BOOL	Rung input state. TRUE - Rising Edge detected, start the instruction block with the precondition that the last operation has been completed. FALSE - Rising Edge not detected, not started.
Cancel	Input	BOOL	TRUE - Cancel the execution of the instruction block. FALSE - when IN is TRUE. Cancel input is dominant.
LocalCfg	Input	MODBUSLOCPARA	Define structure input (local device). Define the input structure for the local device using the <a href="#">MODBUSLOCPARA data type</a> on <a href="#">page 179</a> .
TargetCfg	Input	MODBUSTARPARA	Define structure input (target device). Define the input structure for the target device using the <a href="#">MODBUSTARPARA data type</a> on <a href="#">page 182</a> .
LocalAddr	Input	MODBUSLOCADDR	MODBUSLOCADDR is a 125 Word array that is used by Read commands to store the data (1-125 words) returned by the Modbus slave and by Write commands to buffer the data (1-125 words) to be sent to the Modbus slave.
Q	Output	BOOL	Outputs of this instruction are updated asynchronously from the program scan. Output Q cannot be used to re-trigger the instruction since IN is edge triggered. TRUE - MSG instruction finished successfully. FALSE - MSG instruction is not finished.
Error	Output	BOOL	Indicates an error occurred. TRUE - An error is detected. FALSE - No error.
ErrorID	Output	UINT	A unique numeric that identifies the error. The errors for this instruction are defined in MSG_MODBUS error codes.

### MSG\_MODBUS error codes

This table describes error codes for MSG\_MODBUS.

Error code	Error description
3	The value of the TriggerType has been changed from 2 - 255.
20	The local communication driver is incompatible with the MSG instruction.
21	A local channel configuration parameter error exists.
22	The Target or Local Bridge address is higher than the maximum node address.
33	A bad MSG file parameter exists.
54	A lost modem.
55	The message timed out in the local processor. A link layer timeout.
217	The user cancelled the message.
129	An illegal function.
130	An illegal data address.
131	An illegal data value.
132	A slave device failure.
133	Acknowledge.
134	The slave device is busy.
135	Negative acknowledge.

Error code	Error description
136	A memory parity error.
137	A non-standard reply.
255	The channel has been shut down.

### MSG\_MODBUS Function Block Diagram example

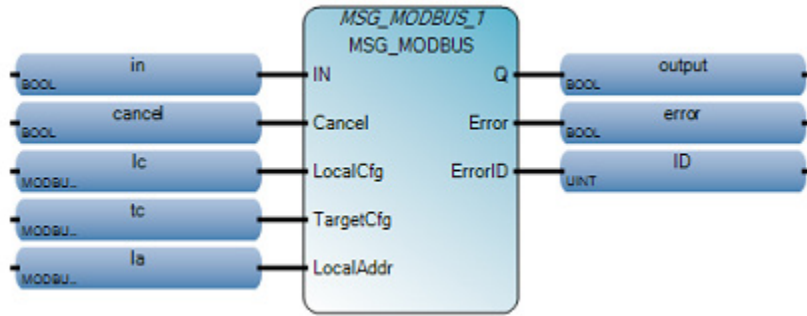

### MSG\_MODBUS Ladder Diagram example

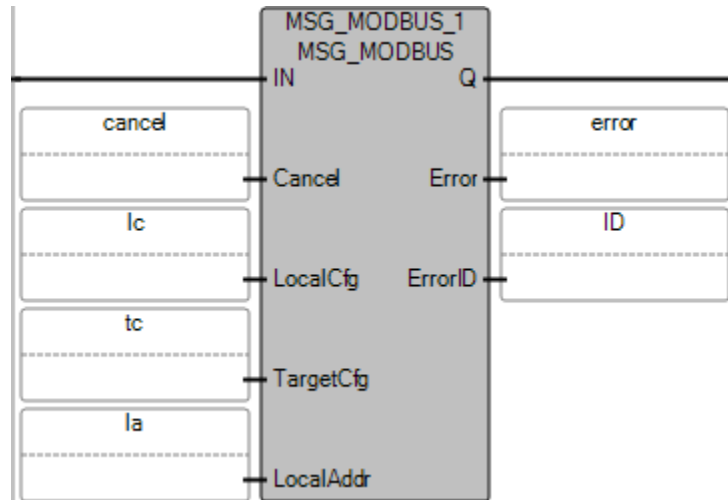

### MSG\_MODBUS Structured Text example

```

MSG_MODBUS_1 |
void MSG_MODBUS_1(BOOL IN, BOOL Cancel, MODBUSLOCPARA LocalCfg, MODBUSTARPARA TargetCfg, MODBUSLOCADDR LocalAddr)
Type : MSG_MODBUS, Send a modbus message via a serial communication port.

1 | MSG_MODBUS_1(in, cancel, lc, tc, la);
2 | output := MSG_MODBUS_1.Q;
3 | error := MSG_MODBUS_1.Error;
4 | ID := MSG_MODBUS_1.ErrorID;

```

### MODBUSLOCPARA data type

Use this table to help determine the parameter values for the MODBUSLOCPARA data type.

Parameter	Data type	Description
Channel	UINT	Micro800 PLC serial port number: <ul style="list-style-type: none"> <li>• 2 for the embedded serial port, or</li> <li>• 5-9 for serial port plug-ins installed in slots 1 through 5</li> <li>• 5 for slot 1</li> <li>• 6 for slot 2</li> <li>• 7 for slot 3</li> <li>• 8 for slot 4</li> <li>• 9 for slot 5</li> </ul>
TriggerType	USINT	Represents one of the following: <ul style="list-style-type: none"> <li>• 0: Msg Triggered Once (when IN goes from False to True)</li> <li>• 1: Msg triggered continuously when IN is True</li> <li>• Other value: Reserved</li> </ul>
Cmd	USINT	Represents one of the following: <ul style="list-style-type: none"> <li>• 01: Read Coil Status (0xxxx)</li> <li>• 02: Read Input Status (1xxxx)</li> <li>• 03: Read Holding Registers (4xxxx)</li> <li>• 04: Read Input Registers (3xxxx)</li> <li>• 05: Write Single Coil (0xxxx)</li> <li>• 06: Write Single Register (4xxxx)</li> <li>• 15: Write Multiple Coils (0xxxx)</li> <li>• 16: Write Multiple Registers (4xxxx)</li> <li>• Others: Custom command support.</li> </ul> <p>MODBUSLOCPARA custom command support:                      Custom Commands in the range of 0-255 that are not already assigned to a Modbus command are also supported. If a custom command is used then the LocalCfg:ElementCnt contains the number of bytes received.                      The response is received into the Local Address Data and overwrites the request data.</p> <ul style="list-style-type: none"> <li>• Example for CMD=0x2B</li> <li>• Local Address Data 1:0x0E, READ_DEVICE_ID_MEI</li> <li>• Local Address Data 2:0x01, READ_DEV_ID_BASIC</li> <li>• Local Address Data 3:0x00, Read Vendor Object</li> </ul>
ElementCnt	UINT	Limits <ul style="list-style-type: none"> <li>• For Read Coil/Discrete inputs: 2000 bits</li> <li>• For Read Register: 125 words</li> <li>• For Write Coil: 1968 bits</li> <li>• For Write Register: 123 words</li> </ul>

### MSG\_MODBUS message triggering

A Modbus message can be triggered periodically by setting a non-zero value to the TriggerType parameter.

This table describes the TriggerType parameter behavior when used with the [MSG\\_MODBUS](#) on [page 177](#) function block.

Action	Results
Message is enabled	Trigger timer starts

Action	Results
Trigger timer expires before the message completes	Message is immediately triggered in the next ladder scan cycle.
Message completes before the trigger time expires	Message is triggered when the trigger time expires.

### Example: message triggering

In the following example, the TriggerType value is set to 100.

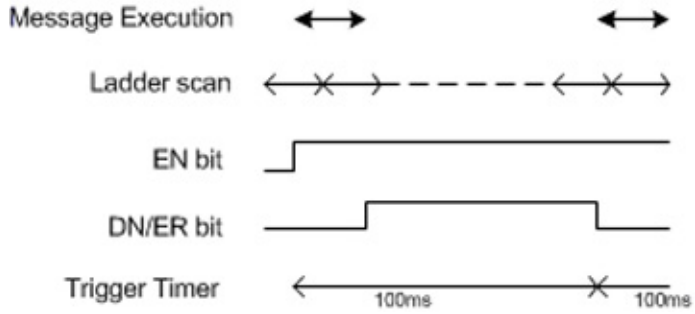

### Message execution process (Rung = TRUE)

The following process diagram describes the message instruction events that occur when the Rung condition is True.

Rung Condition is TRUE

**Com Queue:** Message requests added to this queue has buffer allocated and processed by communication task. Maximum queue size is 4.  
**Wait Queue:** Messages cannot added to the Com queue are added to this queue for later process. No maximum limit.

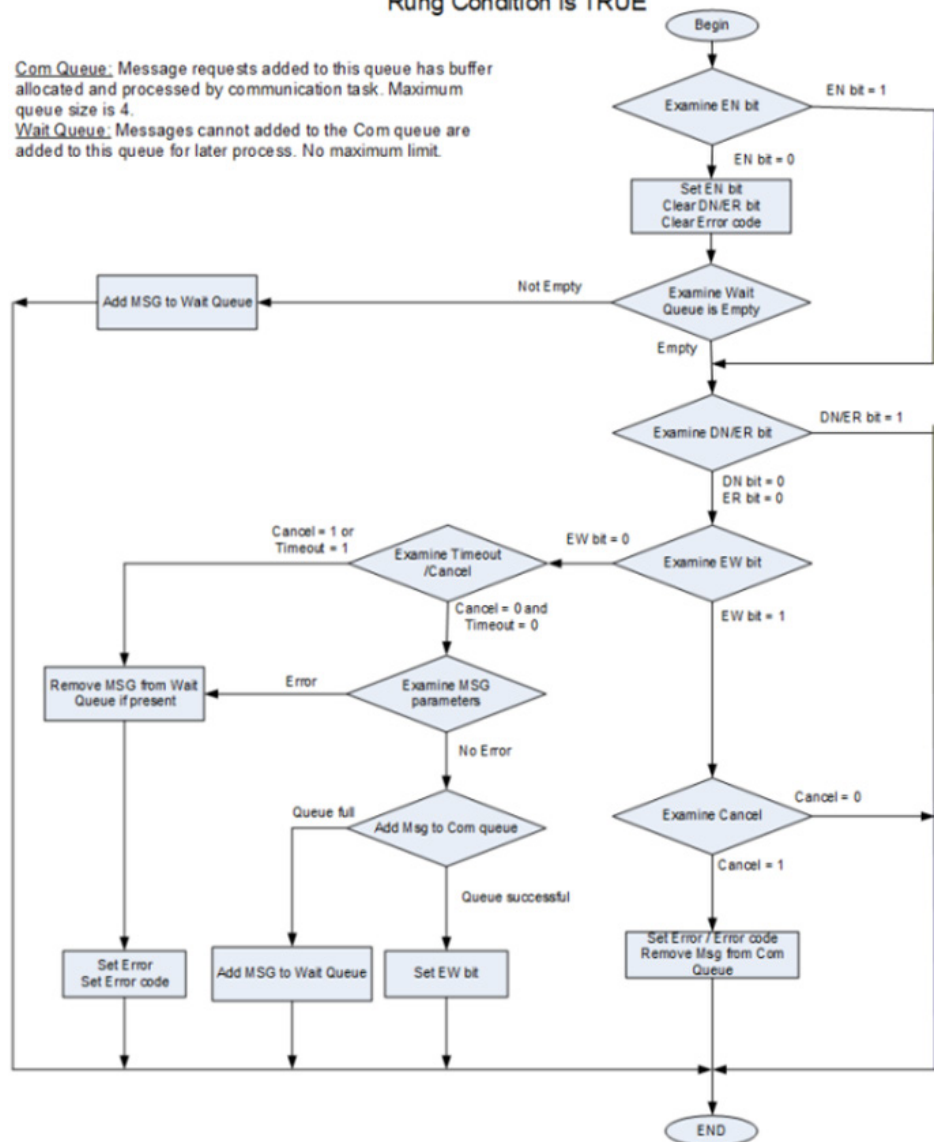

**Com queue:** Message requests added to the Com queue have a buffer allocated and processed by the communication task. The maximum queue size limit is 4.

**Wait queue:** Messages that cannot be added to the Com queue are added to the Wait queue to be processed at a later time. The Wait queue does not have a maximum size limit.

**MODBUSTARPARA data type**

The following table describes the MODBUSTARPARA data type.

Parameter	Data type	Description
Addr	UDINT	Target data address (1 - 65536). Decreases by one when sending.
Node	USINT	The default slave node address is 1. The range is 1- 247. Zero is the Modbus broadcast address and is only valid for Modbus write commands (for example, 5, 6, 15 and 16).

**MSG\_MODBUS2 (MODBUS/TCP message)**

Sends a MODBUS/TCP message over an Ethernet Channel.  
 Operation details:

- A maximum of four message requests per channel can be processed in one scan. For Ladder Diagram programs, message requests are executed at the end of a ladder scan.
- When MSG\_MODBUS2 is enabled, the receive buffers for Read operations are cleared on the rising edge of Enable.
- Canceling the execution of the MSG\_MODBUS2 instruction does not guarantee the message request going out is Cancelled, but does guarantee the response is not processed.

Languages supported: Function Block Diagram, Ladder Diagram, Structured Text.

This instruction applies to the Micro820, Micro850, and Micro870 controllers. For the Micro800 Simulator, this instruction can be added to a program but is only a placeholder to prevent the instruction from being deleted during controller change.

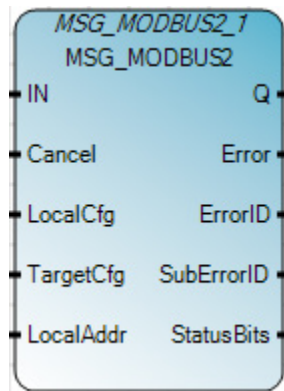

Use this table to help determine the parameter values for this instruction.

Parameter	Parameter Type	Data Type	Description
IN	Input	BOOL	Rung input state. TRUE - Rising Edge detected, start the instruction block with the precondition that the last operation has been completed. FALSE - Rising Edge not detected, idle.
Cancel	Input	BOOL	TRUE - Cancel the execution of the instruction block. Canceling the execution of the MSG_MODBUS2 instruction does not guarantee the message request going out is Cancelled, but does guarantee the response is not processed. FALSE - when IN is TRUE. Cancel input is dominant.
LocalCfg	Input	MODBUS2LOCPARA	Defines structure input (local device). Define the input structure for the local device using the <a href="#">MODBUS2LOCPARA data type on page 186</a> .
TargetCfg	Input	MODBUS2TARPARA	Defines structure input (target device). Define the input structure for the target device using the <a href="#">MODBUS2TARPARA data type on page 187</a> .
LocalAddr	Input	MODBUSLOCADDR	MODBUSLOCADDR data type is a 125 Word array. LocalAddr usage: <ul style="list-style-type: none"> <li>• For Read commands, store the data (1-125 words) returned by the Modbus slave.</li> <li>• For Write commands, buffer the data (1-125 words) to be sent to the Modbus slave.</li> </ul>

Q	Output	BOOL	Outputs of this instruction are updated asynchronously from the program scan. Output Q cannot be used to re-trigger the instruction since IN is edge triggered. TRUE - MSG instruction finished successfully. FALSE - MSG instruction is not finished.
Error	Output	BOOL	Indicates an error detected. TRUE - An error occurred. FALSE - No error.
ErrorID	Output	UINT	A unique numeric that identifies the error. The errors for this instruction are defined in Modbus2 error codes.
SuberrorID	Output	UINT	Used to verify status bits: <ul style="list-style-type: none"> <li>• Bit 0: EN - Enable</li> <li>• Bit 1: EW - Enable Wait</li> <li>• Bit 2: ST - Start</li> <li>• Bit 3: ER - Error</li> <li>• Bit 4: DN - Done</li> </ul> Other bits are reserved.
StatusBits	Output	UINT	SubError code value when Error is TRUE. When a MSG is triggered, or re-triggered, a previously set SubErrorID is cleared.

### MSG\_MODBUS2 error and sub-error codes

When the ER bit is set, the ErrorID and SubErrorID fields display the following error codes.

Error ID	SubErrorID	Description
<b>33</b>	<b>Parameter configuration related errors</b>	
	32	Bad Channel number.
	37	Bad Element count.
	38	Bad Data Address.
<b>55</b>	<b>Timeout related errors</b>	
	112	Message timed out while waiting in the message wait queue.
	113	Message timed out while waiting for the a connection to the link layer to be established.
	114	Message timed out while waiting to transmit to the link layer.
	115	Message timed out while waiting for a response from the link layer.
<b>69</b>	<b>Server Response format related error codes.</b>	
208	No IP address configured for the network.	
209	Maximum number of connections used - no connections available.	
210	Invalid internet address or node address.	
217	Message execution was canceled by user. (Cancel parameter was set to TRUE).	
222	Network connection fail to establish before timeout.	
255	Channel is shutdown or reconfiguration is in progress. Error code occurs immediately after power on until a connection is established, and is normal behavior. It may also occur if an Ethernet cable is disconnected or an IP address cannot be detected.	
	<b>Slave response error codes</b>	
129	Illegal Function Code	
130	Illegal Data Address	
131	Illegal Data Value	



132	Server Failure
133	Acknowledge
134	Negative Acknowledge
136	Memory parity Error
137	Non-standard reply error code. Actual error code can be found in the SubErrorID.

### MSG\_MODBUS2 Function Block Diagram example

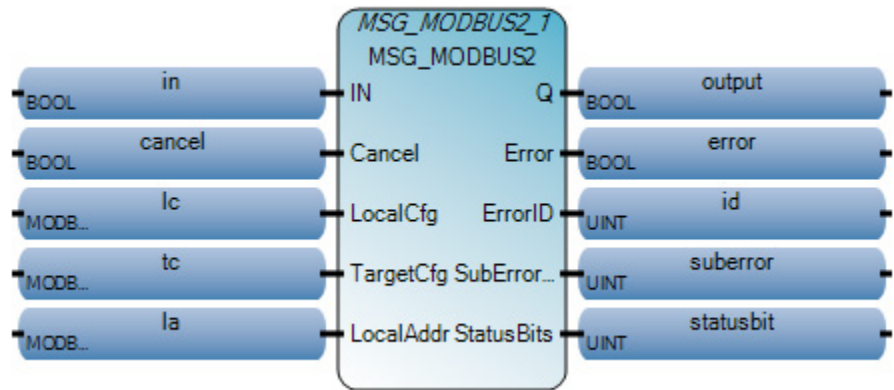

### MS\_MODBUS2 Ladder Diagram example

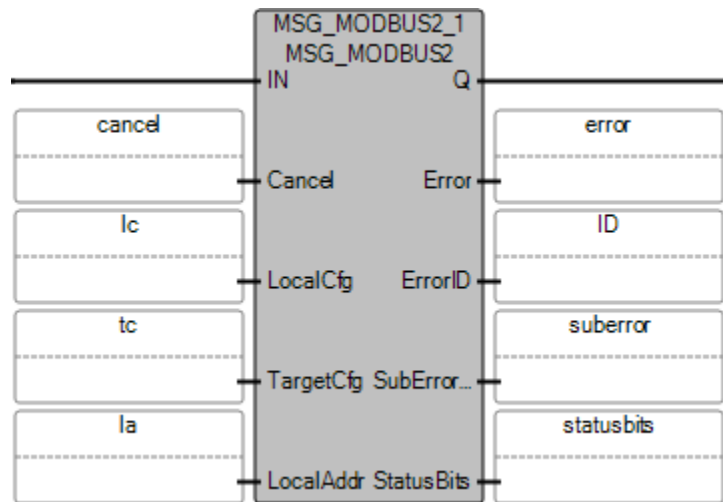

### MSG\_MODBUS2 Structured Text example

```
MSG_MODBUS2_1
void MSG_MODBUS2_1(BOOL IN, BOOL Cancel, MODBUS2LOC PARA LocalCfg, MODBUS2TAR PARA TargetCfg, MODBUS2LOC ADDR LocalAddr)
Type : MSG_MODBUS2, Send a modbus message.
```

```
1 MSG_MODBUS2_1(in, cancel, lc, tc, la);
2 output := MSG_MODBUS2_1.Q;
3 error := MSG_MODBUS2_1.Error;
4 ID := MSG_MODBUS2_1.ErrorID;
```

## MODBUS2LOCPARA data type

Use this table to help determine the parameter values for the MODBUS2LOCPARA data type.

Parameter	Data Type	Description
Channel	UINT	Local Ethernet port number: <ul style="list-style-type: none"> <li>• 4 for Micro850 &amp; Micro820 embedded Ethernet port.</li> </ul>
TriggerType	UDINT	Message trigger type: <ul style="list-style-type: none"> <li>• 0: Msg Triggered Once (when IN goes from False to True)</li> <li>• 1 to 65535 - Cyclic trigger value in milliseconds. Message triggered periodically when IN is true and the previous message execution completes.</li> <li>• Set the value to 1 to trigger messages as quickly as possible.</li> </ul> See below MSG_MODBUS2 message triggering.
Cmd	USINT	Modbus command: <ul style="list-style-type: none"> <li>• 01: Read Coil Status (0xxxx)</li> <li>• 02: Read Input Status (1xxxx)</li> <li>• 03: Read Holding Registers (4xxxx)</li> <li>• 04: Read Input Registers (3xxxx)</li> <li>• 05: Write Single Coil (0xxxx)</li> <li>• 06: Write Single Register (4xxxx)</li> <li>• 15: Write Multiple Coils (0xxxx)</li> <li>• 16: Write Multiple Registers (4xxxx)</li> <li>• Others: Custom command support</li> </ul> MODBUS2LOCPARA custom command support: Custom Commands in the range of 0-255 not already assigned to a Modbus command are also supported. If a custom command is used then LocalCfg:ElementCnt contains the number of bytes received. The response is received in Local Address Data and overwrites the request data. Example for CMD=0x2B: <ul style="list-style-type: none"> <li>• Local Address Data 1:0x0E, READ_DEVICE_ID_MEI</li> <li>• Local Address Data 2:0x01, READ_DEV_ID_BASIC</li> <li>• Local Address Data 3:0x00, Read Vendor Object</li> </ul>
ElementCnt	UINT	Limits <ul style="list-style-type: none"> <li>• For Read Coil/Discrete inputs: 2000 bits</li> <li>• For Read Register: 125 words</li> <li>• For Write Coil: 1968 bits</li> <li>• For Write Register: 123 words</li> </ul>

### MSG\_MODBUS2 message triggering

A Modbus message can be triggered periodically by setting a non-zero value to the TriggerType parameter.

This table describes what happens when the TriggerType parameter is used with the [MSG\\_MODBUS2](#) on [page 182](#) function block.

Action	Results
Message is enabled.	Trigger timer starts.
Trigger timer expires before the message completes.	Message is immediately triggered in the next ladder scan cycle.
Message completes before the trigger time expires.	Message is triggered when the trigger time expires.

## MODBUS2TARPARA data type

Use this table to help determine the parameter values for the MODBUS2TARPARA data type.

Parameter	Data type	Description
Addr	UDINT	Target device's Modbus data address: <ul style="list-style-type: none"> <li>• 1 - 65536.</li> <li>• Decreases by one when sending.</li> <li>• Firmware uses low-word of address if the address value is greater than 65536.</li> </ul>
NodeAddress[4]	USINT	Target device's IP address. The IP address should be a valid unicast address and cannot be 0, multicast, broadcast, local address or loop back address (127.x.x.x). For example, to specify 192.168.2.100: <ul style="list-style-type: none"> <li>• NodeAddress[0]=192</li> <li>• NodeAddress[1]=168</li> <li>• NodeAddress[2]=2</li> <li>• NodeAddress[3]=100</li> </ul>
Port	UINT	Target TCP port number. Standard Modbus/TCP port is 502. 1 - 65535 Set to 0 to use the default value 502
UnitId	USINT	Unit Identifier. Used to communicate with slave devices through a Modbus bridge. Refer Modbus specification for more details. Note that Micro800 shall not attempt to validate this value. 0 - 255 Set to 255 if Target device is not a bridge.
MsgTimeOut	UDINT	Message timeout (in milliseconds). Amount of time to wait for a reply for an initiated command. <ul style="list-style-type: none"> <li>• 250-10,000</li> <li>• Set to 0 to use the default value 3,000.</li> <li>• A value less than 250 (minimum) is set to 250.</li> <li>• A value greater than 10,000 (maximum) is set to 10,000.</li> </ul> See Modbus/TCP message timeout timers.
ConnTimeOut	UDINT	TCP Connection establishment timeout (in milliseconds). Amount of time to wait for establishing successful TCP connection to the Target device. <ul style="list-style-type: none"> <li>• 250-10,000</li> <li>• Set to 0 to use the default value 5,000.</li> <li>• A value less than 250 (minimum) is set to 250.</li> <li>• A value greater than 10,000 (maximum) is set to 10,000.</li> </ul> See Modbus/TCP message timeout timers.
ConnClose	BOOL	TCP connection closing behavior. <ul style="list-style-type: none"> <li>• True - Close the TCP connection upon message completion.</li> <li>• False - Do not close the TCP connection upon message completion [Default].</li> </ul> See Modbus/TCP message connections.

### Modbus/TCP message timeout timers

This table describes the behavior for MsgTimeOut and ConnTimeOut based on message requests and status.

Action	Results
Message is enabled.	Activates the MsgTimeOut timer.
TCP connection is requested.	Activates the ConnTimeOut timer.

Action	Results
ConnTimeOut timer is active.	Disables the MsgTimeOut timer.
Connection request is complete.	Reactivates the MsgTimeOut timer.

### Modbus/TCP message connections

Modbus/TCP client supports a maximum of 16 connections. This table describes Modbus/TCP connection behavior.

Scenario	Results
Message request is enabled, and a connection to the target does not exist.	If a connection to the target does not exist, a new connection is established. If a connection to the target already exists, the existing connection is used.
Message execution is completed, and ConnClose is set to True.	If there is only one connection to the target, the connection is closed. If there is more than one connection to the target, the connection is closed when the last message execution is completed.
Message execution is completed, and ConnClose is set to False.	The connection is not closed.
Connection is not associated with an active message, and remains idle for the amount of time specified in ConnTimeOut parameter.	The connection is closed.
Controller transitions from an executing mode (Run, Remote Run, Remote Test Single Scan and Remote Single Rung) to a non-executing mode.	All active connections are forcibly closed.

### MSG\_PCCC (programmable controller communication commands message)

Sends a PCCC message over an Ethernet channel or a serial port.

The commands supported: SLC Typed Read and SLC Typed Write.

Operation details:

- When sending the PCCC message over an Ethernet channel and more than four function block requests are in queue for CIP\_GENERIC\_FB, CIP\_SYMBOLIC, or PCCC\_MSG\_FB, up to four messages per channel can be processed in one scan.

For Ladder Diagram programs, message requests are executed at the end of a ladder scan.

- When sending the PCCC message over a serial port and more than eight function block requests are in queue for serial communication, a total of eight messages on all channels can be processed in one scan.

For Ladder Diagram programs, message requests are executed at the end of a ladder scan.

Languages supported: Function Block Diagram, Ladder Diagram, Structured Text.

The instruction applies to the Micro870 L70E controllers.



Use this table to help determine the parameter values for this instruction.

Parameter	Parameter Type	Data Type	Description
IN	Input	BOOL	Rung input state. TRUE - Rising Edge detected, start the function block with the precondition that the last operation has been completed. FALSE - Rising Edge not detected, not started.
CtrlCfg	Input	CIPCONTROLCFG	Function block execution control configuration. Use the <a href="#">CIPCONTROLCFG data type</a> on <a href="#">page 190</a> to define CtrlCfg.
PCCCCfg	Input	PCCC_CFG	The PCCC commands and address. Use the <a href="#">PCCCCFG data type</a> on <a href="#">page 191</a> to define PCCCCfg.
TargetCfg	Input	CIPTARGETCFG	Target device configuration. Use the <a href="#">TARGETCFG data type</a> on <a href="#">page 192</a> to define TargetCfg.
Q	Output	BOOL	True - The MSG instruction is completed. False - The MSG instruction is not completed.
Status	Output	CIPSTATUS	The execution status of the function block. When an MSG instruction is triggered or retriggered, all the Status elements are reset. The Status output is defined in <a href="#">CIPSTATUS data type</a> on <a href="#">page 194</a> .
DataLength	Output	UINT	The number of data bytes for CIPCCC message response. When an MSG is triggered or retriggered, DataLength is reset to 0. DataLength is supported when a PCCC message is sent over an Ethernet channel.

### MSG\_PCCC Function Block Diagram example

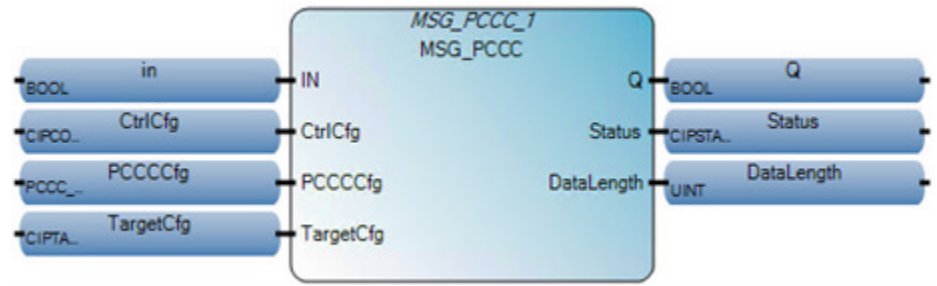

### MSG\_PCCC Ladder Diagram example

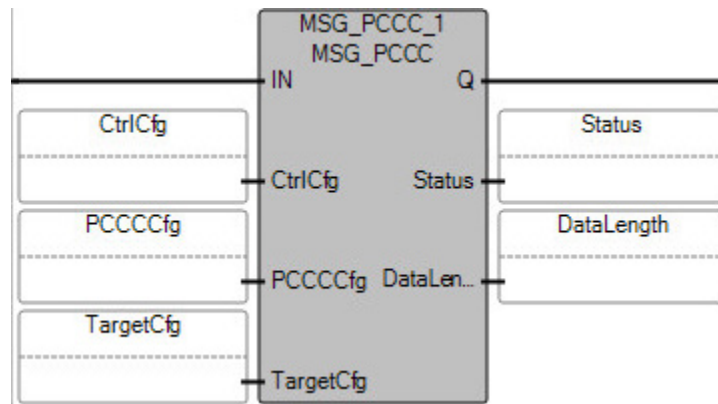

### MSG\_PCCC Structured Text example

```
MSG_PCCC_1|
void MSG_PCCC_1(BOOL IN, CIPCONTROLCFG CtrlCfg, PCCC_CFG PCCCCfg, CIPTARGETCFG TargetCfg)
Type : MSG_PCCC, Send a PCCC Message

2 Q=MSG_PCCC_1.Q;
3 Status=MSG_PCCC_1.Status;
4 DataLength=MSG_PCCC_1.DataLength|
```

### CIPCONTROLCFG data type

Use this table to help determine the parameter values for the CIPCONTROLCFG data type.

Parameter	Data Type	Description
Cancel	BOOL	TRUE - Cancel the execution of the function block. Bit is cleared when the message is enabled.
TriggerType	UDINT	Represents one of the following: <ul style="list-style-type: none"> <li>• 0: Msg Triggered Once (when IN goes from False to True)</li> <li>• 1 to 65535: Cyclic trigger value in milliseconds. Msg is triggered periodically when IN is True. Set the value to 1 to trigger the MSG as quickly as possible.</li> </ul>
StrMode	USINT	Reserved for future use.

### PCCC message triggering

The message is triggered periodically by setting a non-zero value to the TriggerType parameter.

Action	Results
Message is enabled	Trigger timer starts.
Trigger timer expires before the message completes	Message is immediately triggered in the next ladder scan cycle.
Message completes before the trigger time expires	Message is triggered when the trigger time expires.

### Example: message triggering

In the following example, the TriggerType value is set to 100.

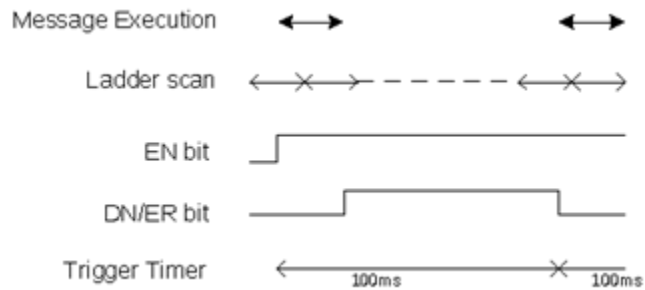

### PCCCFG data type

Use this table to define the parameters for the PCCCFG data type.

Parameter	Data Type	Description
Service	USINT	Service code: <ul style="list-style-type: none"> <li>• 0 - Read (default)</li> <li>• 1 - Write</li> </ul>
SrcAdr	STRING	Source address: <ul style="list-style-type: none"> <li>• Source file name if the value of Source is 0 Syntax: &lt;File Type&gt;&lt;File Number&gt;:&lt;Element Number&gt; Example: N7:1</li> <li>The supported data types are:                             <ul style="list-style-type: none"> <li>• N (Integer)</li> <li>• F (Float)</li> <li>• B (Bool)</li> <li>• L (Long)</li> <li>• ST (String)</li> </ul> </li> <li>• Tag variable name if the value of Service is 1                             <ul style="list-style-type: none"> <li>• Example of a 1-D array: testarrayVariable1[x], where x is the position of the array in the array range. One-dimension arrays are supported.</li> <li>• Example of a normal variable or a 1-D array whose index starts from 0: VariableName1.</li> </ul> </li> </ul>

Parameter	Data Type	Description
NumOfElements	UINT	<p>The number of elements:</p> <ul style="list-style-type: none"> <li>• When Service is 0, the maximum number of elements (Element value * single Element occupied bytes) cannot exceed 244.</li> <li>• When Service is 1, the maximum number of elements (Element value * single Element occupied bytes) cannot exceed 232.</li> </ul>
DstAdr	STRING	<p>Destination address:</p> <ul style="list-style-type: none"> <li>• Source file name if the value of Service is 1 Syntax: &lt;File Type&gt;&lt;File Number&gt;:&lt;Element Number&gt; Example: N7:1 The supported data types are: <ul style="list-style-type: none"> <li>• N (Integer)</li> <li>• F (Float)</li> <li>• B (Bool)</li> <li>• L (Long)</li> <li>• ST (String)</li> </ul> </li> <li>• Tag variable name if the value of Service is 0 <ul style="list-style-type: none"> <li>• Example of a 1-D array: testarrayVariable2[x], where x is the position of the array in the array range. One-dimension arrays are supported.</li> <li>• Example of a normal variable or a 1-D array whose index starts from 0: VariableName2.</li> </ul> </li> </ul>

## TARGETCFG data type

Use this table to help determine the parameter values for the TARGETCFG data type.

Parameter	Data Type	Description
Path	STRING[80]	<p>Path of the target defined using the syntax [<i>"&lt;port&gt;,&lt;node/slot address&gt;"</i>]</p> <p>Port number definition:</p> <ul style="list-style-type: none"> <li>• 2 for embedded serial port</li> <li>• 4 for embedded Ethernet port</li> <li>• 5-7 for 2080-SERIALISOL plug-in module installed in slots 1-3</li> </ul>
CipConnMode	USINT	<p>CIP Connection type.</p> <ul style="list-style-type: none"> <li>• 1 - Class3 connection</li> </ul> <p>The parameter must be set to 1 for Ethernet and serial PCCC messages.</p>



Parameter	Data Type	Description
UcmmTimeout	UDINT	<p>Unconnected message timeout (in milliseconds). The amount of time to wait for a reply for unconnected messages, including connection establishment for connected messages.</p> <ul style="list-style-type: none"> <li>Valid values: 250-10,000 ms.</li> <li>Set to 0 to use the default value of 3,000 ms (3 seconds).</li> <li>A value set to less than 250 ms will be set to 250 ms (minimum).</li> <li>A value set to greater than 10,000 ms will be set to 10,000 ms (maximum).</li> </ul> <p>The parameter is applicable for EtherNet/IP.</p>
ConnMsgTimeout	UDINT	<p>Class3 Connection timeout (in milliseconds). The amount of time to wait for a reply for connected messages. The connection closes when the timeout expires.</p> <ul style="list-style-type: none"> <li>Valid values: 800-10,000 ms.</li> <li>Set to 0 to use the default value of 10,000 ms (10 seconds).</li> <li>A value set to less than 800 will be set to 800 ms (minimum).</li> <li>A value set to greater than 10,000 ms will be set to 10,000 ms (maximum).</li> </ul> <p>The parameter is applicable for EtherNet/IP and serial.</p>
ConnClose	BOOL	<p>Connection closing behavior:</p> <ul style="list-style-type: none"> <li>TRUE - Close the connection when the message completes.</li> <li>FALSE - Do not close the connection when the message completed (default).</li> </ul> <p>The parameter is applicable for EtherNet/IP.</p>

### Target path example

The following table lists example values used in a target path string and describes the results for each string.

String Element	Description
"6,1"	Through the serial port plug-in module mounted in slot 2 to the node at address 1. Note that plug-in slots 1-3 equate to ports 5-7.
"4,192.168.1.100"	Through Port 4, Micro870 embedded Ethernet port, reaches the Node at 192.168.1.100.
Local port	Local port used to send out the message. The port should be an active EtherNet/IP or CIP Serial port - USB ports are not supported.

String Element	Description
Target address	<ul style="list-style-type: none"> <li>For EIP, the target address specifies the target's IP address. The IP address must be a unicast address and cannot be 0, or a multicast, broadcast, local, or loopback (127.x.x.x) address.</li> <li>For CIP Serial, the target address specifies the target's node address. The supported range of values is from 0 through 254.</li> </ul>

**IMPORTANT** When triggering an MSG\_PCCC instruction out of a serial port, the user must include a message timeout timer in order to error out the message instruction in case an error-free response is not received within a reasonable amount of time, especially when using radio modems. The timer preset time should be set by the user depending on their application. An example is shown below.

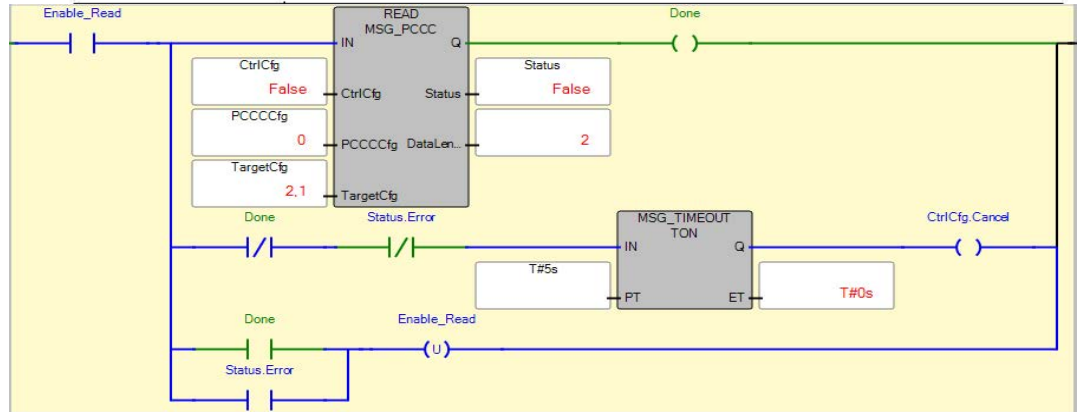

### CIPSTATUS data type

Use this table to determine the parameter values for the CIPSTATUS data type.

Parameter	Data Type	Description
Error	BOOL	This bit is set to TRUE when the function block execution encounters an error condition.
ErrorID	UINT	Error code value. For more information, see the <a href="#">error code table on page 196</a>
SubErrorID	UINT	Sub Error code value.
ExtErrorID	UINT	CIP extended status error code value.
StatusBits	UINT	<p>This parameter can be used to verify control bits:</p> <ul style="list-style-type: none"> <li>• Bit 0: EN – Enable</li> <li>• Bit 1: EW – Enable Wait</li> <li>• Bit 2: ST – Start</li> <li>• Bit 3: ER – Error</li> <li>• Bit 4: DN – Done</li> <li>• Bit 5: CIPCONN – CIP Connection Closure</li> <li>• Bit 6: EIPSESS – EIP Session Closure</li> </ul> <p>Bit 5 and Bit 6 are for Ethernet/IP and other bits are reserved.</p> <p>StatusBits are defined for <a href="#">CIPSTATUS status bits on page 194</a>.</p>

### CIPSTATUS status bits

The CIPSTATUS status bits are set based on the status of the message execution, the communication buffers, and the rung conditions.

Bit Name	Description	Behavior
EN	Enable	Set when the rung goes true and remains set until either the DN bit or the ER bit is set, and the rung goes false.

Bit Name	Description	Behavior
EW	Enable Waiting	Set when the communication buffer is allocated for the message request. Cleared when the ST bit is set.
ST	Start	Set when the message has been transmitted and is waiting for a reply. Cleared when the DN bit is set.
ER	Error	Set when message transmission fails. An error code is written to ErrorID. The ER bit and error code values are cleared the next time the rung goes from false to true.
DN	Done	Set when the message is transmitted successfully. The DN bit is cleared the next time the rung goes from false to true.
CIPCONN	Done	Set when the CIP Connection for the Communication is closed. The CIPCONN bit is applicable when ConnClose is True, for other cases the CIPCONN bit is False. The bit is used for Ethernet only.
EIPSESS	Done	Set when the Encapsulation CIP Session for the Communication is closed. The EIPSESS bit is applicable when ConnClose is True, for other cases the EIPSESS bit is False. The bit is used for Ethernet only.



Tip: When the message is enabled (EN bit is set) and is not done (DN bit is not set), if the Cancel parameter is set, then message execution ends, and the ER bit is set.

## CIP/EIP message connections

A maximum of 16 CIP (class 3) and 16 EIP connections are supported for client message execution. The following table describes the CIP/EIP connection behavior. All the following scenarios are applicable for Ethernet.

Scenario	Results
Message request is enabled and CipConnMode=1.	If a connection to the target does not exist, a CIP connection is established. If the message's local port is Ethernet and an EIP connection to the target does not exist, an EIP connection is established prior to establishing a CIP connection.
Message request is enabled, CipConnMode=0, and the message's local port is Ethernet.	If an EIP connection to the target does not exist, an EIP connection is established. If multiple messages are designated to the same target, the messages must use the same connection.
ConnClose is true, the message connection and EIP Session are closed upon completion of the message execution.	If multiple messages share the same connection, then the connection is closed upon completion of the last message.
Message execution is completed, and ConnClose is set to False.	The connection is not closed upon completion of the message execution.
A CIP or EIP connection that is not associated with any active message is closed if it is idle for x seconds, where x is a configurable Encapsulation Inactivity Timeout value that can be set using the CIP Set Service.	See CIP Specification Volume II TCP/IP objects for details about the CIP Set Service.

Scenario	Results
A CIP connection is closed and any EIP connection is also closed.	If multiple CIP connections are using the same EIP connection, the EIP connection is closed when all the associated CIP connections are closed.
Controller transitions from an executing mode (Run, Remote Run, Remote Test Single Scan and Remote Single Rung) to a non-executing mode.	All active connections are forcibly closed.

## Message timeout

The following table describes how timers for inUcmmTimeout and ConnMsgTimeout parameters behave based on message requests and status.

Action	Results
Message is enabled	UcmmTimeout timer is activated
CIP Connection is requested	ConnMsgTimeout timer is activated
ConnMsgTimeout timer is active	UcmmTimeout timer is disabled Applicable for Ethernet/IP
Connection request is completed	UcmmTimeout timer is reactivated Applicable for Ethernet/IP

## MSG\_PCCC error codes

Use this table to determine the parameter values for the ErrorID and SubErrorID fields when ER bit is set.

ErrorID code	SubErrorID code	Error code description
30		SubErrorID represents the Status (STS) Remote Error. For more information, see Chapter 8 of the <a href="#">DF1 Protocol and Command Set Reference Manual</a> .
31		SubErrorID represents the Extended Status (EXT STS) Remote Error. For more information, see Chapter 8 of the <a href="#">DF1 Protocol and Command Set Reference Manual</a> .
32	<b>PCCC Configuration error</b>	
	1	Unsupported Service code The supported Service codes are: <ul style="list-style-type: none"> <li>• 0 - Read (default)</li> <li>• 1 - Write</li> </ul>
	2	Invalid source address For correct source addresses, see SrcAdr in the <a href="#">PCCCCFG data type</a> on <a href="#">page 191</a> table. For the String data type, the supported fixed string size is 82.
	3	Invalid destination address For correct source addresses, see DstAdr in the <a href="#">PCCCCFG data type</a> on <a href="#">page 191</a> table. For the String data type, the supported fixed string size is 82.
	4	Invalid source data type The supported data types are: <ul style="list-style-type: none"> <li>• N (Integer)</li> <li>• F (Float)</li> <li>• B (Bool)</li> <li>• L (Long)</li> <li>• ST (String)</li> </ul>

ErrorID code	SubErrorID code	Error code description
	5	Invalid destination data type The supported data types are: <ul style="list-style-type: none"> <li>• N (Integer)</li> <li>• F (Float)</li> <li>• B (Bool)</li> <li>• L (Long)</li> <li>• ST (String)</li> </ul>
	6	File type and Symbol data type are not compatible. The float data type sends messages only to or from float data types.
	41	Invalid CIP symbol name
	48	The function block's input data array size is not sufficient. Verify that the data buffer size exceeds the requested data length.
33	<b>Parameter configuration related errors</b>	
	32	Bad Channel number.
	36	Unsupported CIP connection type. Make sure the parameter CipConnMode is set to 1 for PCCC messages.
	48	Invalid Element count The range for Element count is from 1 to the maximum. For more information, see the Element count table.
	49	Invalid Target path.
	51	Invalid pay load or the size of the function block's transmitting data array is excessive for CIP communication.
	52	Bad Segment type value
	53	Bad UCCM timeout value If the encapsulation timeout value is less than UCCM timeout or the difference between encapsulation timeout and UCCM timeout is less than or equal to one second, the error is reported. This code is applicable for Ethernet/IP.
	54	Bad connected timeout value If the encapsulation timeout value is less than CONNECTED message timeout or the difference between encapsulation timeout and CONNECTED message time out is less than or equal to one second, the error is reported. This code is applicable for EtherNet/IP.
	<b>Timeout related errors</b>	
55	112	Message timed out while waiting in the message wait queue. To avoid this problem, verify that the number of executing function blocks is equal to or less than four for each port.
	113	Message timed out while waiting for the connection to the link layer to be established. To avoid this problem, you must ensure that: <ul style="list-style-type: none"> <li>• The cable works and the target exists.</li> <li>• The controller supports processing a maximum of eight CIP client messages.</li> </ul>
	114	Message timed out while waiting to transmit to the link layer. To avoid this problem, verify that the controller supports processing up to eight CIP client messages.
	115	Message timed out while waiting for a response from the link layer. To avoid this problem, verify that the target exists, and the cables are working.
	<b>Server response format related error codes</b>	
69	65	Message reply does not match request.
	68	Message reply data type is not valid or not supported.
208		There is no IP address configured for the network. To solve the problem, configure a valid IP address. The code is applicable for EtherNet/IP.

ErrorID code	SubErrorID code	Error code description
209		Maximum number of connections used – no connections available. To avoid this problem, reduce the number of connections that are used. The code is applicable for EtherNet/IP.
210		Invalid internet address or node address To avoid this problem, do not use 0, broadcast, multicast, or loop back for the target IP address. The code is applicable for EtherNet/IP.
217		Message execution was canceled by the user (Cancel parameter was set to TRUE). To avoid this problem, do not set the Cancel bit or perform the RMD operation.
218		No network buffer space available To avoid this problem, verify that there is not an undue amount of ongoing communication activity. The code is applicable for EtherNet/IP.
222		Reserved.
223		The link address is not available. A TCP/IP or Ethernet configuration change is in progress. This code is applicable for EtherNet/IP.
224		CIP response error code SubErrorID specifies the CIP status and ExtErrorID specifies the CIP extended status value. See the CIP specification for possible error code values. The code is applicable for EtherNet/IP.
255		Channel is shutdown or reconfiguration is in progress. You might encounter this error when the reconfiguration is in progress, or the port is not available when you are executing the MSG_CIPPPCC instructions. To avoid this problem, wait for the configuration to complete before executing the instructions. The code is applicable for EtherNet/IP.

### Element count table

Source/Destination Data Type	Maximum Element Count for Service Code of 0 - read Service	Maximum Element Count for Service Code of 1 - write Service
BIT	122	116
INT	122	116
FLOAT	61	58
STRING	2	2
DOUBLE	61	58

For information on creating an MSG\_PCCC program, see [Example: How to create an MSG\\_PCCC messaging program to write a value to and read a value from an address in MicroLogix](#) on [page 198](#).

### Example: Create an MSG\_PCCC messaging program to write a value to and read a value from an address in MicroLogix

This example shows how to create a message program to write a value to a Controller A legacy address from Controller B global variable and read a value from Controller A legacy address and saved to Controller B global variable over ethernet.

Controller A  
Catalog: 1766-L32BWA  
IP Address: 192.168.3.33  
Subnet Mask: 255.255.255.0



Controller B  
Catalog: 2080-L70E-24QBB  
IP Address: 192.168.3.3  
Subnet Mask: 255.255.255.0

## PCCC Write example: Add an MSG\_PCCC function block, variables, and a contact

To create an MSG\_PCCC messaging program used to write a value to a legacy address in MicroLogix 1400 from a Micro870E controller, perform the following tasks.

### To create a global variable for the source variable

1. In the **Project Organizer**, double-click **Global Variables** to display the **Global Variables** selector.
2. Enter **Write\_Float\_Data** in the **Name** Column.
3. Verify the datatype is REAL.

The **Global Variables** selector should look similar to the following image.

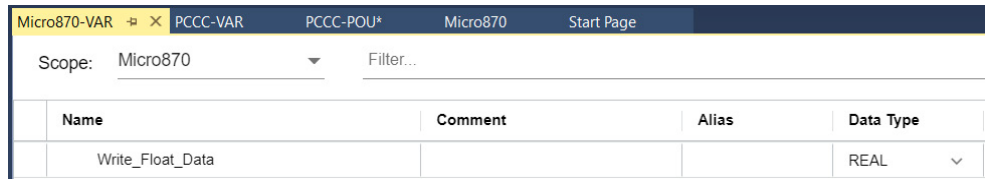

### To add function block and variables

1. In the **Instruction Toolbar - Messaging**, select **MSG\_PCCC** and drag it onto the ladder rung.

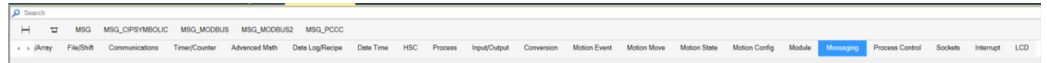

2. (optional) Double-click **MSG\_PCCC** to change the instance of the function block to **Write\_PCCC**.

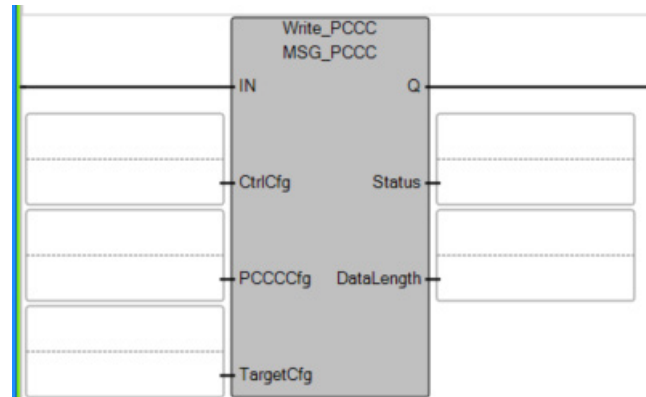

3. Assign variable names.
  - a. In **Project Organizer**, double-click **Local Variables** to display the **Local variables** page.
  - b. In the **Variables Selector**, add the variables and data types listed in the table.
  - c. Assign the variables to the instruction input and output parameters.

Parameter	Variable Name	Data Type
CtrlCfg	Write_CtrlCfg	CIPCONTROLCFG

Parameter	Variable Name	Data Type
PCCCCfg	Write_PCCC	PCCC_CFG
TargetCfg	Write_TarCfg	CIPTARGETCFG
Status	Write_Sts	CIPSTATUS

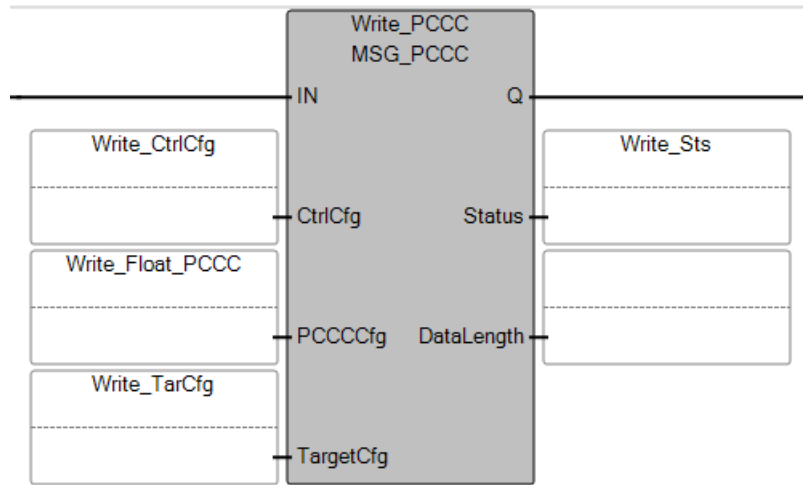

4. Configure initial values for the local variables and add CtrlCfg initial values.
  - a. From the **Local Variables** page, expand the CtrlCfg parameter to view additional parameters.
  - b. Enter the following values in the **Initial Value** column for each parameter.

Parameter	Initial Value
Write_CtrlCfg.Cancel	Leave Blank
Write_CtrlCfg.TriggerType	50
Write_CtrlCfg.StrMode	Leave Blank



Tip: 50 is entered in this example to define a 50ms cyclic trigger interval.

5. Add PCCCCfg initial values.
  - a. From the **Local Variables** page, expand the PCCCCfg parameter to view additional parameters.
  - b. Enter the following values in the **Initial Value** column for each parameter.

Parameter	Initial Value
Write_Float_PCCC.Service	1
Write_Float_PCCC.SrcAdr	'Write_Float_Data'
Write_Float_PCCC.NumOfElements	1
Write_Float_PCCC.DstAdr	'F8:0'



Tip: F8:0 is entered as the destination address in the MicroLogix controller.



The Local variables selector should look similar to the following image.

Name	Comment	Initial Value	Data Type
Write_CtrlCfg		...	CIPCONTROLCFG
Write_CtrlCfg.Cancel	Abort the execution ...		BOOL
Write_CtrlCfg.TriggerType	0 - Trigger once, n - ...	50	UDINT
Write_CtrlCfg.StrMode	reserved parameter		USINT
Write_Float_PCCC		...	PCCC_CFG
Write_Float_PCCC.Service	0-Read, 1-Write	1	USINT
Write_Float_PCCC.SrcAdr	Source address:In c...	'Write_Float_Data'	STRING
Write_Float_PCCC.NumOfElements	Number of elements	1	USINT
Write_Float_PCCC.DstAdr	Destination address...	'F8:0'	STRING

6. Configure initial values for TarCfg.
  - a. From the **Local Variables** page, expand the TarCfg parameter to view additional parameters.
  - b. Enter the following values in the **Initial Value** column for each parameter.

Parameter	Initial Value
Write_TarCfg.Path	'4,192.168.3.33'
Write_TarCfg.CipConnMode	1
Write_TarCfg.UcmmTimeout	0
Write_TarCfg.ConnMsgTimeout	0
Write_TarCfg.ConnClose	FALSE

The Local variables selector should look similar to the following image.

Name	Comment	Initial Value	Data Type
Write_TarCfg		...	CIPTARGETCFG
Write_TarCfg.Path	CIP destination path	'4,192.168.3.33'	STRING
Write_TarCfg.CipConnMode	0 - Unconnected, 1 - Cl...	1	USINT
Write_TarCfg.UcmmTimeout	Unconnected message ...	0	UDINT
Write_TarCfg.ConnMsgTimeout	Connected message ti...	0	UDINT
Write_TarCfg.ConnClose	TRUE: Close CIP conn...	FALSE	BOOL

7. Add a contact.
  - a. In the **Instruction Toolbar - Favorite**, select **Direct Contact** and drag it to the left of the MSG\_PCCC function block input on the first ladder rung.
  - b. Click the contact and assign the **Write** variable to the contact.

The rung of your ladder diagram program for MSG\_PCCC messaging should look similar to the following image.

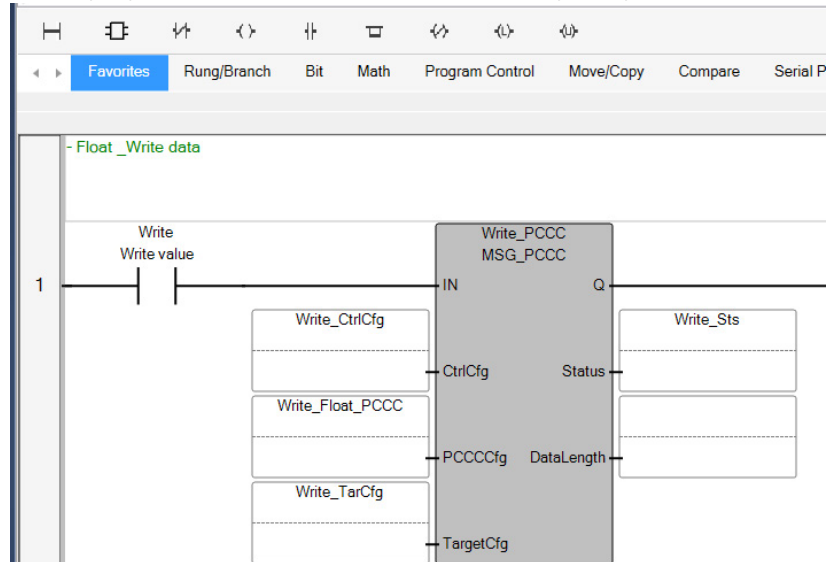

8. Download the program.

After the download is complete, enter the value to write to MicroLogix into **Write\_Float\_Data** variable in the Micro800 controller and trigger the **Write** tag to perform a write value from the Write\_Float\_Data to the MicroLogix controller F8:0 address. Observe the MicroLogix address is being updated to the value.

### PCCC Read example: Add a PCCC\_MSG function block, variables, and a contact

To create an MSG\_PCCC messaging program used to read a value from a legacy address in MicroLogix 1400 to a Micro870E controller, perform the following tasks.

#### To create a global variable for storing the results

1. In the **Project Organizer**, double-click **Global Variables** to display the **Global Variables** selector.
2. Enter **Read\_Float\_Data** in the **Name** Column.
3. Verify the datatype is REAL.

The **Global Variables** selector should look similar to the following image.

Name	Comment	Alias	Data Type
Read_Float_Data			REAL

#### To add function block and variables

1. In the **Instruction Toolbar - Messaging**, select **MSG\_PCCC** and drag it onto the ladder rung.

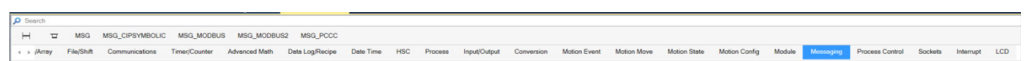

2. (optional) Double-click **MSG\_PCCC** to change the instance of the function block to Read\_PCCC.

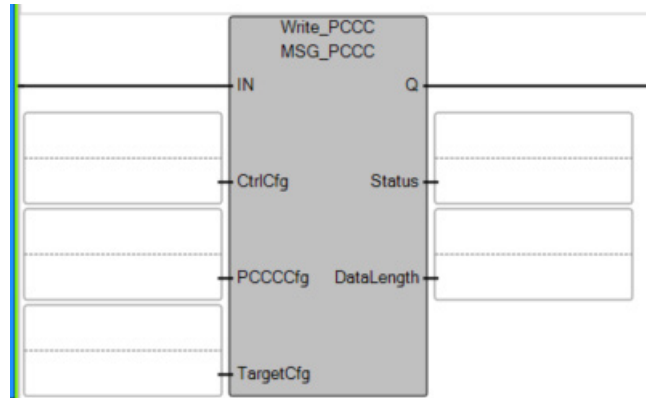

3. Assign variable names.
  - a. In **Project Organizer**, double-click **Local Variables** to display the **Local variables** page.
  - b. In the **Variables Selector**, add the variables and data types listed in the table.
  - c. Assign the variables to the instruction input and output parameters.

Parameter	Variable Name	Data Type
CtrlCfg	Read_CtrlCfg	CIPCONTROLCFG
PCCCCfg	Read_PCCC	PCCC_CFG
TargetCfg	Read_TarCfg	CIPTARGETCFG
Status	Read_Sts	CIPSTATUS

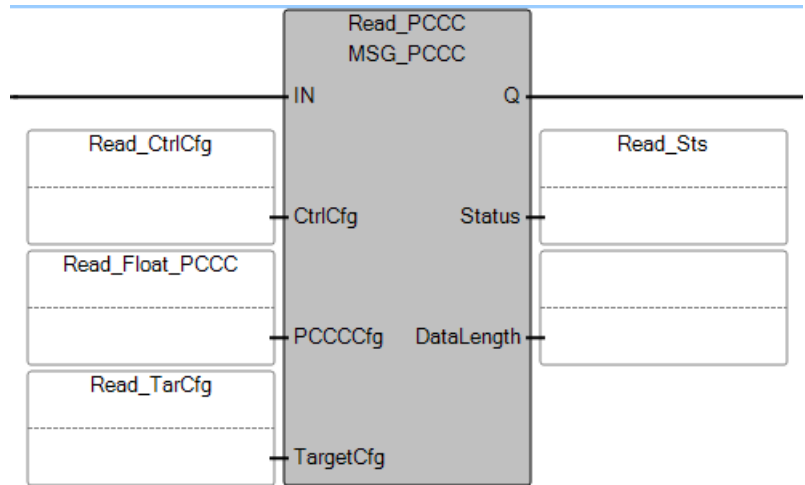

4. Configure initial values for the local variables and add CtrlCfg initial values.
  - a. From the **Local Variables** page, expand the CtrlCfg parameter to view additional parameters.
  - b. Enter the following values in the **Initial Value** column for each parameter.

Parameter	Initial Value
-----------	---------------

Parameter	Initial Value
Read_CtrlCfg.cancel	Leave Blank
Read_CtrlCfg.TriggerType	50
Read_CtrlCfg.StrMode	Leave Blank



Tip: 50 is entered in this example to define a 50ms cyclic trigger interval.

5. Add PCCCCfg initial values.
  - a. From the **Local Variables** page, expand the PCCCCfg parameter to view additional parameters.
  - b. Enter the following values in the **Initial Value** column for each parameter.

Parameter	Initial Value
Read_Float_PCCC.Service	1
Read_Float_PCCC.SrcAdr	'F8:0'
Read_Float_PCCC.NumOfElements	1
Read_Float_PCCC.DstAdr	'Read_Float_Data'



Tip: F8:0 is entered as the Source address in the MicroLogix controller.

The Local variables selector should look similar to the following image.

Name	Comment	Initial Value	Data Type
Read_CtrlCfg		...	CIPCONTROLCFG
Read_CtrlCfg.Cancel	Abort the execution of ...		BOOL
> Read_CtrlCfg.TriggerType	0 - Trigger once, n - Cy...	50	UDINT
> Read_CtrlCfg.StrMode	reserved parameter		USINT
Read_Float_PCCC		...	PCCC_CFG
> Read_Float_PCCC.Service	0-Read, 1-Write	1	USINT
Read_Float_PCCC.SrcAdr	Source address: In case...	'F8:0'	STRING
> Read_Float_PCCC.NumOfElements	Number of elements	1	USINT
Read_Float_PCCC.DstAdr	Destination address: In ...	'Read_Float_Data'	STRING

6. Configure initial values for TarCfg.
  - a. From the **Local Variables** page, expand the TarCfg parameter to view additional parameters.
  - b. Enter the following values in the **Initial Value** column for each parameter.

Parameter	Initial Value
Read_TarCfg.Path	'4,192.168.3.33'
Read_TarCfg.CipConnMode	1
Read_TarCfg.UcmmTimeout	0
Read_TarCfg.ConnMsgTimeout	0
Read_TarCfg.ConnClose	FALSE

The Local variables selector should look similar to the following image.

Name	Comment	Initial Value	Data Type
Read_TarCfg		...	CIPTARGETCFG
Read_TarCfg.Path	CIP destination path	'4,192.168.3.33'	STRING
> Read_TarCfg.CipConnMode	0 - Unconnected, 1 - Cl...	1	USINT
> Read_TarCfg.UcmmTimeout	Unconnected message ...	0	UDINT
> Read_TarCfg.ConnMsgTimeout	Connected message ti...	0	UDINT
Read_TarCfg.ConnClose	TRUE: Close CIP conn...	FALSE	BOOL

7. Add a contact.
  - a. In the **Instruction Toolbar - Favorite**, select **Direct Contact** and drag and drop it to the left of the MSG\_PCCC function block input on the second ladder rung.
  - b. Click the contact and assign the **Read** variable to the contact.

The rung of your ladder diagram program for MSG\_PCCC messaging should look similar to the following image.

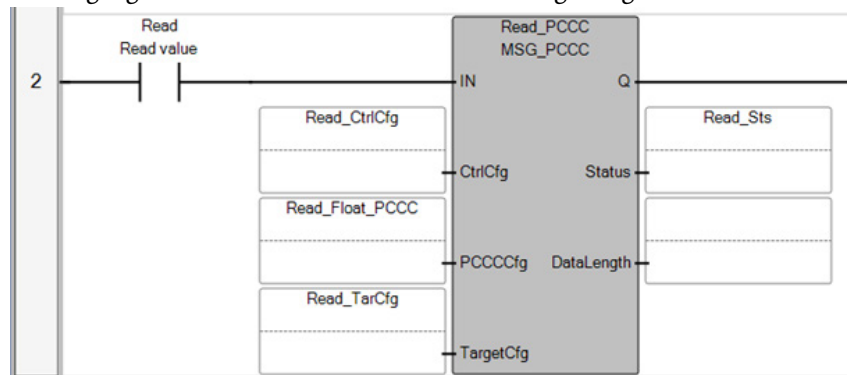

8. Download the program.
 

After the download is complete, enter the value in the MicroLogix controller F8:0 address and trigger the Read tag in Micro800 controller to perform a read value from MicroLogix F8:0 address and observe the value written to the Read\_Float\_Data in the Micro800 controller.

## Message execution processes and timing diagrams

The following topics describe how and when [MSG\\_CIPGENERIC](#) on page 165, [MSG\\_CIPSYMBOLIC](#) on page 173, [MSG\\_MODBUS2](#) on page 182, and [MSG\\_PCCC](#) on page 188 message instructions execute based on their bit and rung conditions.

- Message execution process (general)
- Message execution process (Rung = TRUE)
- Message execution timing diagram (Rung = True)
- Message execution process (Rung = FALSE)
- Message execution timing diagram (Rung = FALSE)
- Message execution process (Error)
- Message execution timing diagram (PCCC configuration error)
- Message execution timing diagram (message is canceled)

## Message execution process (general)

The following diagram shows how and when messages execute based on the status of the Com queue.

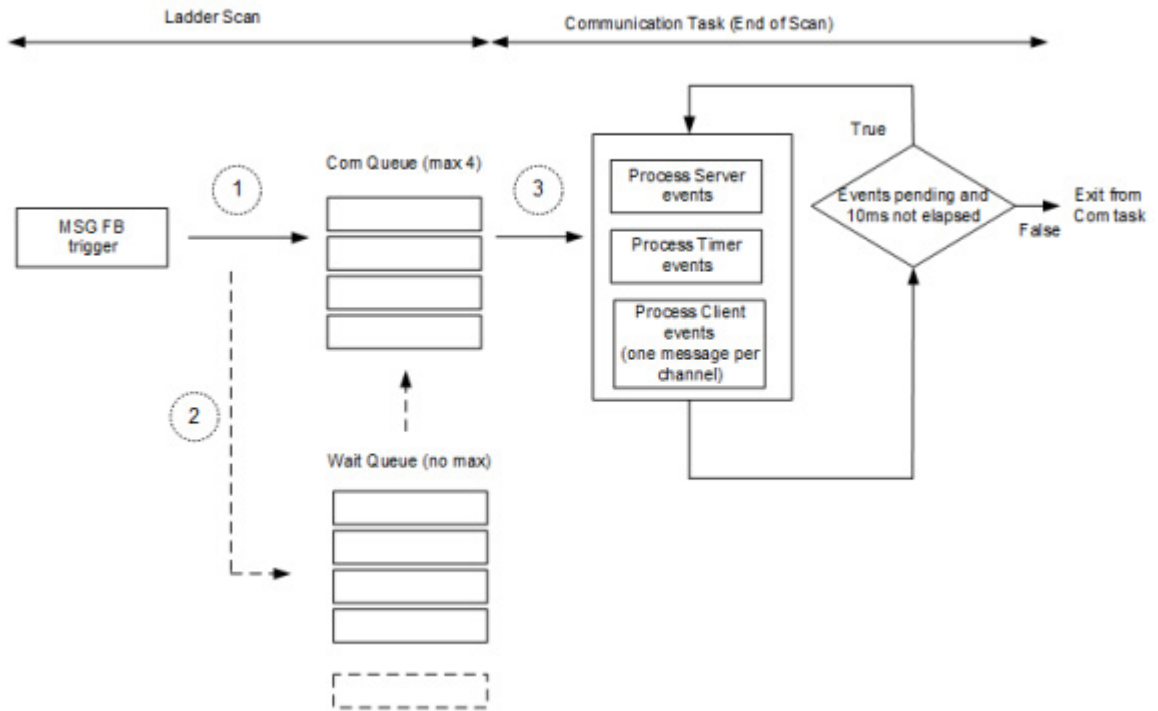

The following table describes the sequence of events identified in the preceding diagram.

No.	Description of events
1	The message is enabled. If the Com queue is empty, the buffer is allocated for the message and the message is added to the Com queue for transmission. The Com queue size is 4 and each channel has a separate queue.
2	If the Com queue is full, the message is added to the Wait Queue. When the Com queue is empty, the message in the Wait queue is added to the Com queue. There is no size limit for the Wait Queue and each channel has a separate queue.
3	The communication task executes the messages in the Com queue on every End-of-Scan for transmission. Each channel's queue is processed one by one in a round robin fashion. One message from each channel is executed, and the process continues until all messages are executed or the communication schedule (10ms) expires. The channel next to the last processed channel is scheduled to appear first in the next End-of-Scan.

### Message execution process (Rung = TRUE)

The following process diagram describes the message instruction events that occur when the Rung condition is True.

Rung Condition is TRUE

**Com Queue:** Message requests added to this queue has buffer allocated and processed by communication task. Maximum queue size is 4.  
**Wait Queue:** Messages cannot added to the Com queue are added to this queue for later process. No maximum limit.

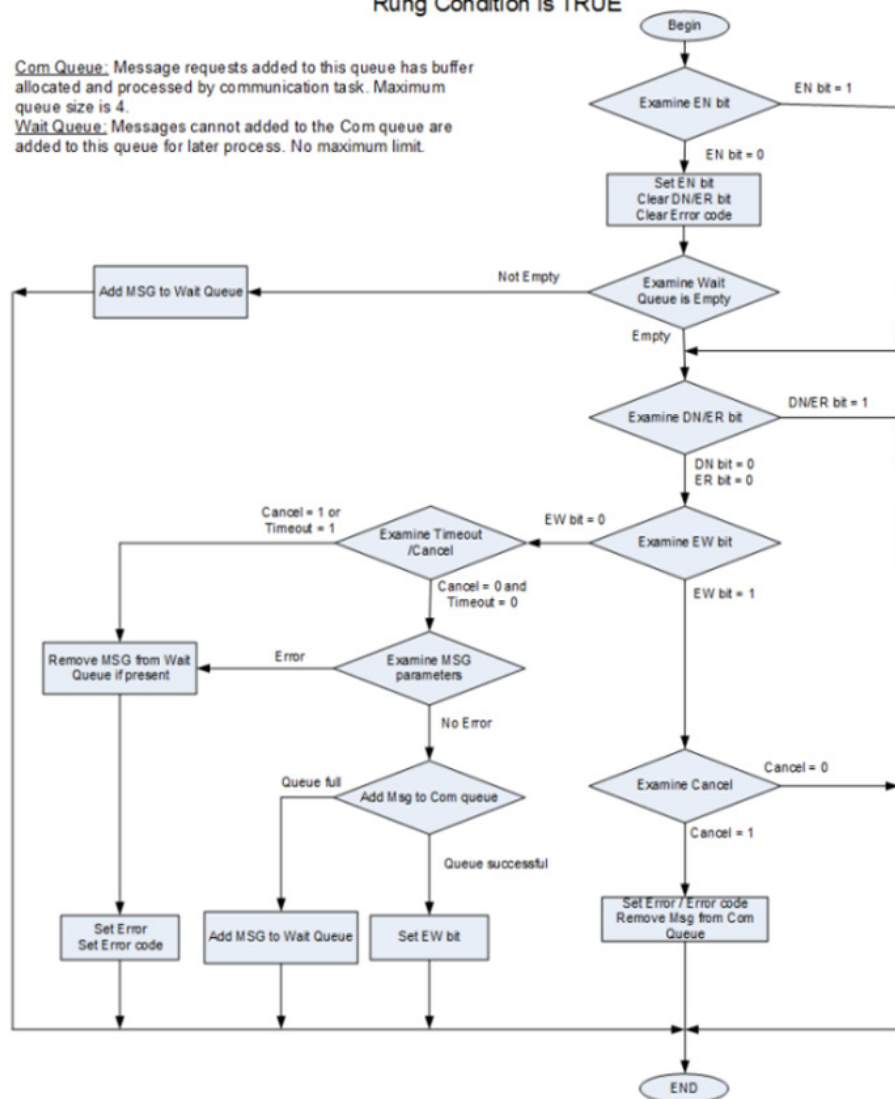

**Com queue:** Message requests added to the Com queue have a buffer allocated and processed by the communication task. The maximum queue size limit is 4.

**Wait queue:** Messages that cannot be added to the Com queue are added to the Wait queue to be processed at a later time. The Wait queue does not have a maximum size limit.

**Message execution timing diagram (Rung = TRUE)**

The following table describes the message conditions and bit status for each execution step identified in the timing diagram while the rung condition remains true.

Step	Message description	Bit status
1	Rung condition goes TRUE. Message execution is enabled.	EN bit is set. All other bits are cleared.
2	Message control buffer is acquired. At this time, input data (that is, the "data" parameter for write messages) is copied for transmission. Subsequent changes to the input data will not be reflected in the transmitted message.	EW bit is set.

Step	Message description	Bit status
3	Message transmission starts.	EW bit is cleared. ST bit is set.
4	Message response is received.	ST bit is cleared. DN bit is set.
5	Rung condition goes FALSE.	EN bit is cleared.

**Timing diagram for (Rung = TRUE)**

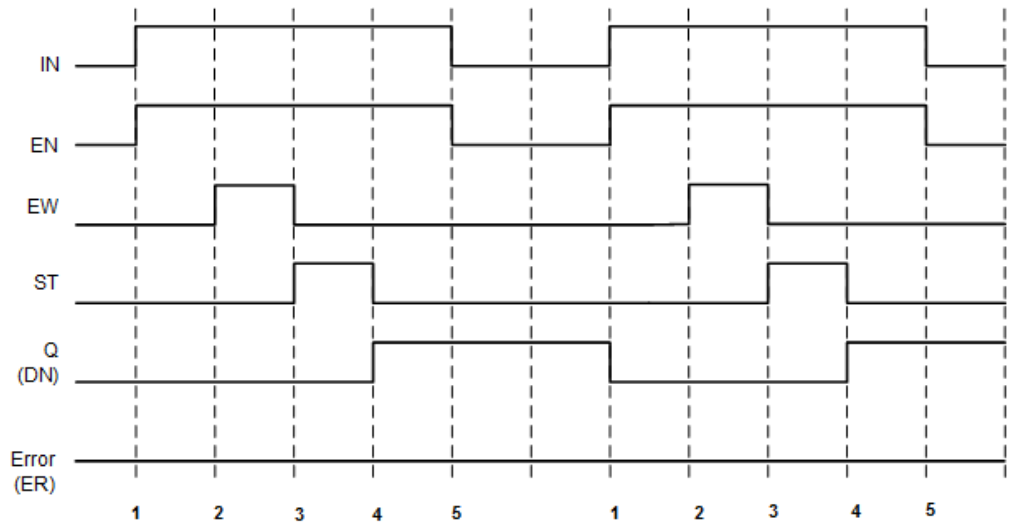

**Message execution process (Rung = FALSE)**

The following process diagram describes the message instruction events that occur when the Rung condition is False.



Rung Condition is FALSE

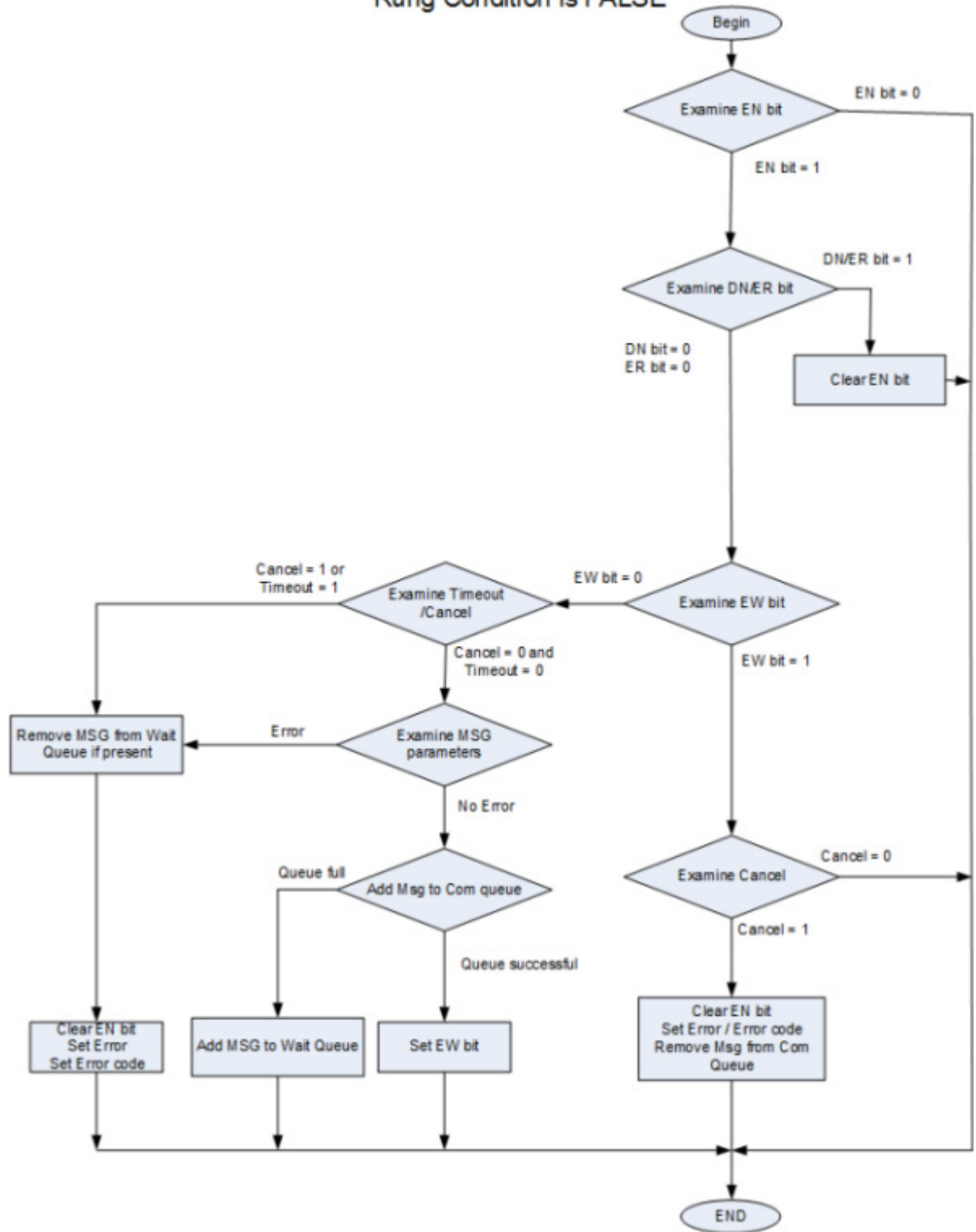

**Message execution timing diagram (Rung = FALSE)**

The following table describes the message conditions and bit status for each execution step identified in the timing diagram when the rung goes to FALSE during execution.

Step	Message description	Bit status
------	---------------------	------------

Step	Message description	Bit status
1	Rung condition goes TRUE. Message execution is enabled.	EN bit is set. All other bits are cleared.
2	Rung condition goes FALSE. Message execution continues.	
3	Message buffer is acquired. At this time, input data (that is, the "data" parameter for write messages) is copied for transmission. Subsequent changes to the input data will not be reflected in the transmitted message.	EW bit is set.
4	Message transmission starts.	EW bit is cleared. ST bit is set.
5	Message response is received.	ST bit is cleared. DN bit is set.
6	Message is scanned again after step 5.	EN bit is cleared.

### Timing diagram for (Rung = FALSE)

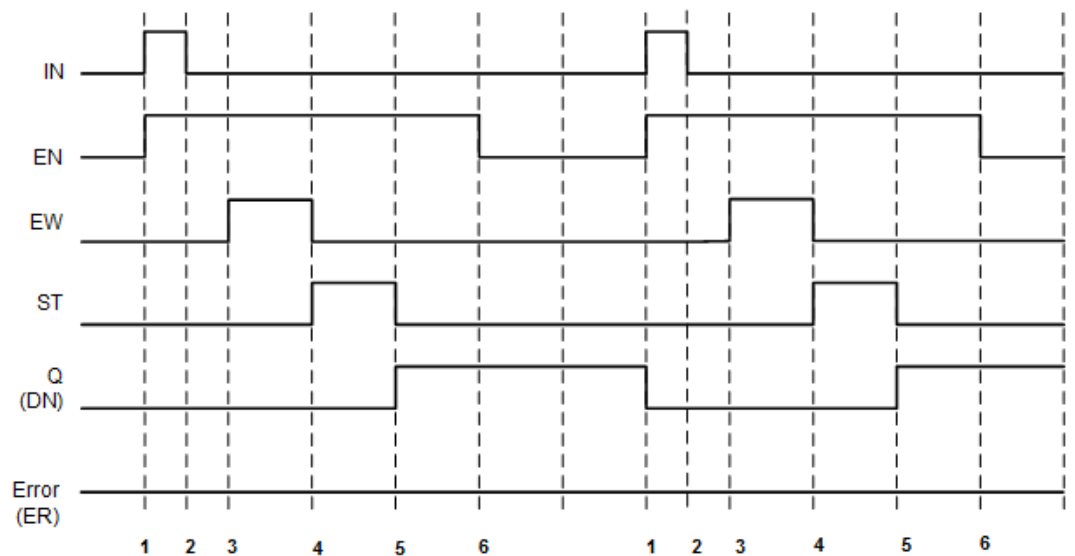

### Message execution process (Error)

The following table describes the message conditions and bit status for each execution step identified in the timing diagram when an error occurs during execution.

Step	Message description	Bit status
1	Rung condition goes TRUE. Message execution is enabled.	EN bit is set. All other bits are cleared.
2	Message buffer is acquired.	EW bit is set.
3	Message transmission starts.	EW bit is cleared. ST bit is set.
4	Message transmission times out.	EW and ST bits do not change.
4-6	As rung condition goes FALSE.	EN bit is cleared. ER bit is set.

### Message execution timing diagram (Error)

The following timing diagram shows a typical pattern when an error occurs during execution.

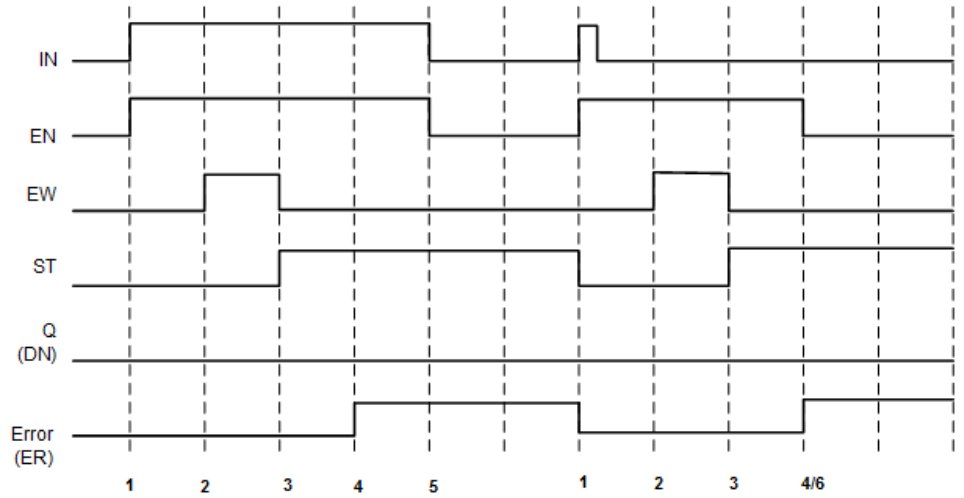

### Message execution timing diagram (PCCC configuration error)

The following table describes the message conditions and bit status for each execution step identified in the timing diagram when a PCCC configuration error occurs during execution.

Step	Message description	Bit status
1	Rung condition goes TRUE. Message execution is enabled.	EN bit is set.
2	Message buffer is acquired.	EW bit is set.
3	Invalid elements exist in PCCCCfg.	ER bit is set to 1 before ST bit is set to 1. EW and ST bits do not change.
4	As rung condition goes FALSE.	EN, EW, and ER bits are cleared.

The following diagram shows the typical error condition when changing the number of elements in PCCCCfg to an invalid number 17.

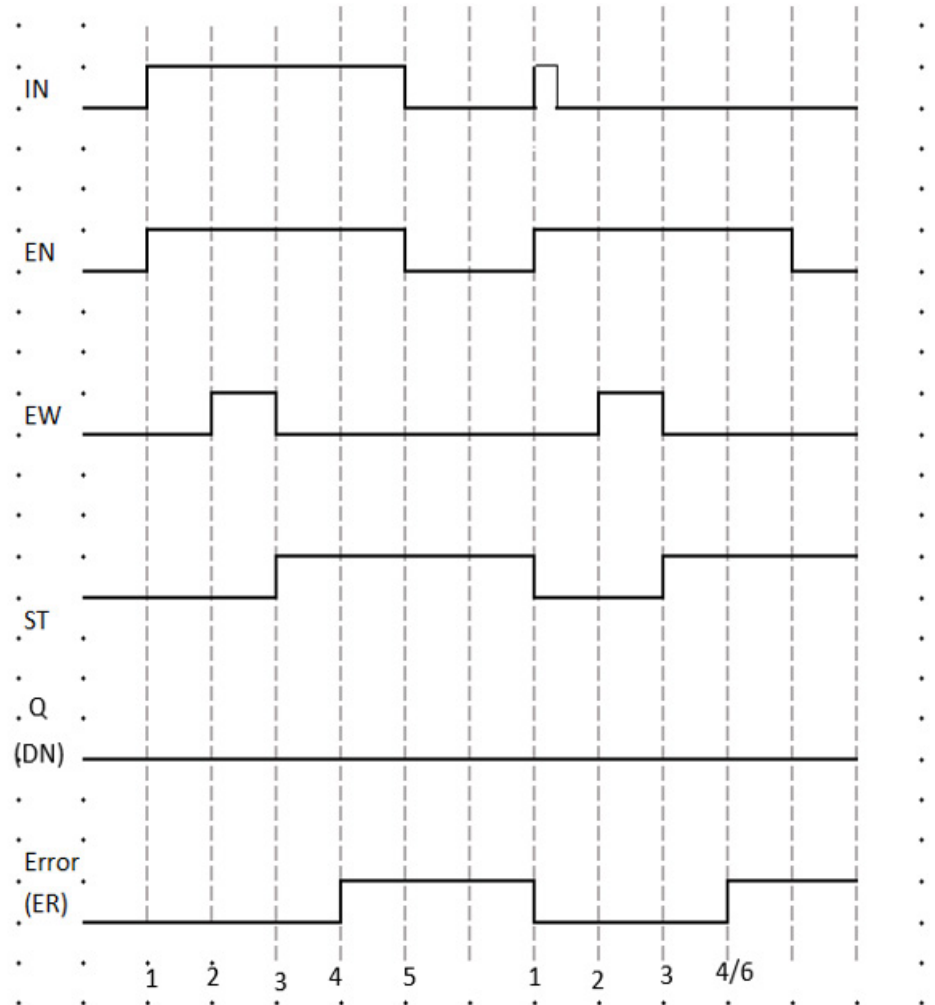

**Message execution timing diagram (message is canceled)**

The following table describes the message conditions and bit status for each execution step identified in the timing diagram when a message is canceled.

Step	Message description	Bit status
1	Rung condition goes TRUE. Message execution is enabled.	EN bit is set. All other bits are cleared.
2	Message buffer is acquired.	EW bit is set.
3	Message execution get canceled.	ER bit is set. EW and ST bits do not change.
4	Rung condition goes FALSE.	EN bit is cleared.
5	Rung condition goes TRUE.	The Cancel input is cleared. The function block starts to execute.

### Timing diagram when a the message is canceled

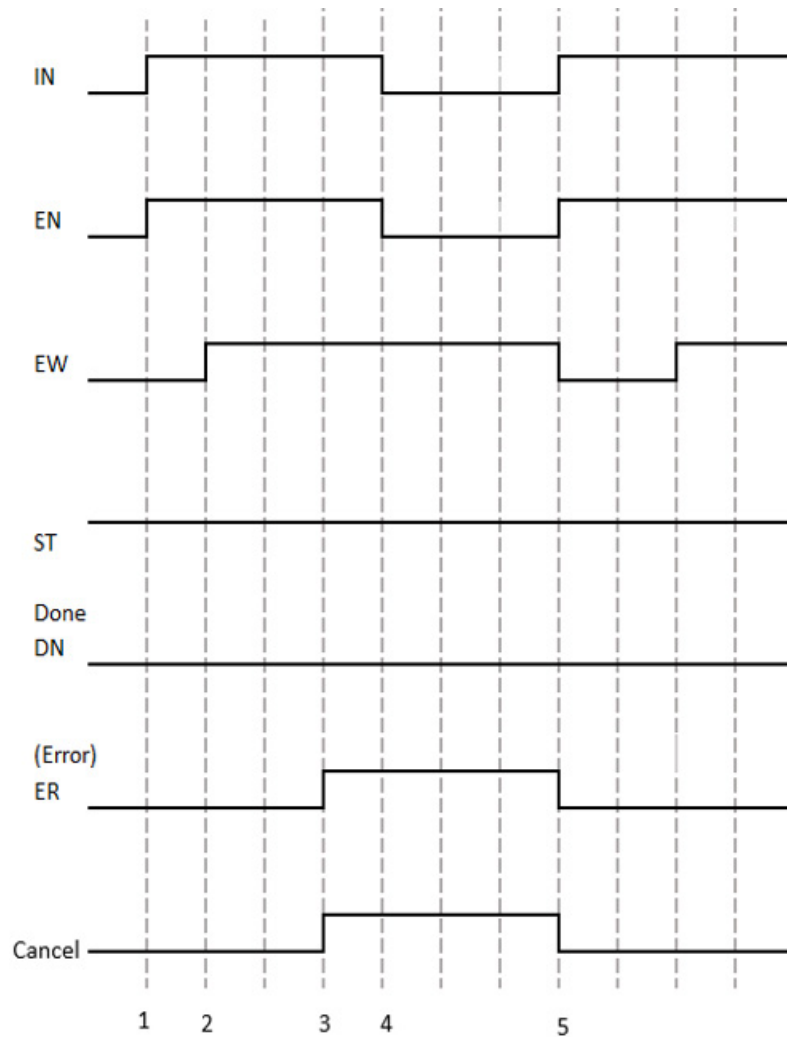

### Use the communication (message) function blocks

### Configure object data values for explicit messaging (MSG\_CIPGENERIC)

This section provides specific details and examples for using [communication instructions](#) on [page 163](#) in logic programs. See the following topics for details of and [examples for using the MSG\\_CIPGENERIC](#) on [page 215](#) and [MSG\\_CIPSYMBOLIC function blocks to create programs](#) on [page 223](#).

To use the [MSG\\_CIPGENERIC](#) on [page 165](#) function block for explicit messaging, configure the AppCfg parameter with the correct values.

### For additional information about message communication

There are several sources of information covering the implementation and use of message communication, including Connected Components Workbench Help, user manuals and the Rockwell Automation Literature Library.

The following table lists additional sources of information relevant to message communication.

Information source	Description	How to find the information
--------------------	-------------	-----------------------------

User manual for your specific communication device	Contains important information about messaging and specific information for configuring message function blocks.	Connected Components Workbench Help menu
EtherNet/IP Adapter 22-COMM-E FRN 1.xxx, Appendix C	Provides information about the EtherNet/IP objects that can be accessed using Explicit Messages.	Connected Components Workbench Help menu
EtherNet/IP specification	Defines the objects to be included in every CIP device: Identity object, Message Router object and the Network object.	ODVA web site ( <a href="http://www.odva.org">http://www.odva.org</a> )
Micro800 Programmable Controllers: Getting Started with CIP Client Messaging	Provides quickstart instructions for using CIP GENERIC and CIP Symbolic Messaging in Micro830 and Micro850 programmable logic controllers (PLC).	Rockwell Automation Literature Library

### To access user manuals and quickstart guides:

1. To access quickstart guides, on the **Help** menu, click **View Help**.
2. Double-click on **Connected Components Workbench**.
3. Double-click on **Getting Started with Connected Components Workbench**.
4. To access drive manuals, on the **Help** menu, click **User Manuals** to display the Manuals dialog box.
5. Click the plus (+) sign next to Drives to expand the category, and then expand the class until the manual is located.
6. Double-click the manual name to open the .pdf file.
7. To access the EtherNet/IP manual, on the **Help** menu, click **User Manuals** to display the Manuals dialog box.
8. Click the plus (+) sign next to **Drives** to expand the category, and then expand the PowerFlex 4-class Peripherals class.
9. Double-click the 22-COMM-E EtherNet/IP Adapter User Manual to open the .pdf file.

### To access manuals from the Rockwell Automation Literature Library:

1. Go to <http://literature.rockwellautomation.com>.
2. To access non-English language versions of user manuals, select the language from the Publication Language drop-down box (right corner).
3. Enter the full or partial device catalog number in the **Search** box. For example, enter 2080-LC30 to view Micro830 user manuals.
4. In the **Search** box, type the full or partial device catalog number. For example, enter 2080-LC30 to view Micro830 user manuals.

### CIP Register object data

MSG\_CIPGENERIC function blocks use the CIP Register object data in the AppCfg parameter. The object data includes the following:

- Class Code
- Instance

- Instance Attribute
- Service

### Values for the MSG\_CIPGENERIC AppCfg parameter

Use the values from the CIP register object in your input variables to configure the MSG\_CIPGENERIC function block parameters. The following image shows the CIP register object data values used in the MSG\_CIPGENERIC function block parameters.

Name	Alias	Data Type	Dimen	Project Val	Initial Val
MSG_ReadDrive		MSG_CIPGENERIC		...	...
MyAppCfg		CIPAPPCFG		...	...
MyAppCfg.Service		USINT			14
MyAppCfg.Class		UINT			7
MyAppCfg.Instance		UDINT			4
MyAppCfg.Attribute		UINT			4
MyAppCfg.MemberC		USINT			

### Example: How to create an MSG\_CIPGENERIC messaging program to read data from a controller

This example shows how to create a message program that retrieves Controller B catalog information from Controller A using a MSG\_CIPGENERIC function block and a COP function block.

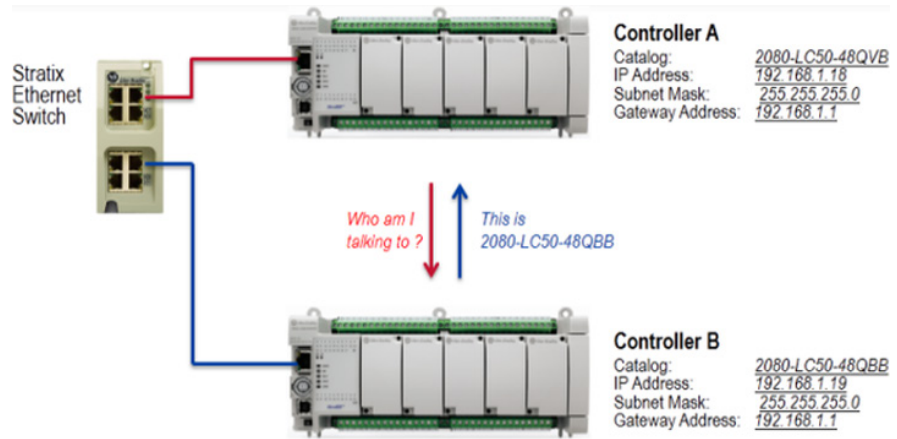

Perform the following tasks to create a MSG\_CIPGENERIC messaging program that reads information from a different controller.

No	Task
1	<a href="#">Identify initial values for the input variables (MSG_CIPGENERIC) on page 216</a>
2	<a href="#">Add a MSG_CIPGENERIC function block and variables on page 216</a>
3	<a href="#">Configure initial values for variables on page 217</a>
4	<a href="#">Add a contact and a coil on page 220</a>
5	<a href="#">Add a COP function block, variables and contact (MSG_CIPGENERIC) on page 221</a>
6	<a href="#">Verify correct IP configuration on Controller B on page 222</a>

## Identify initial values for the input variables, MSG\_CIPGENERIC

Follow these general steps to add input variables and initial values, and obtain the Identity Object values to configure the AppCfg parameter initial values.

### To add input variables and initial values:

1. From the **Help** menu, click **User Manuals**.
2. Expand the Drives selection and locate the user manual for the type of communication adapter you are using (EtherNet/IP Adapter User Manual).
3. Double-click the manual to open it.
4. Review the Appendix headings to locate the section that provides information about the EtherNet/IP objects that can be accessed using Explicit Messages (Appendix C).
5. Go to the Appendix section and identify the object type related to your explicit message (Identity object).
6. Identify the initial values for the AppCfg parameters based on the type information being retrieved.

### Ethernet/IP object data and AppCfg parameters example

The following table identifies the specific Ethernet/IP object data used to read catalog information from a controller.

Input variable example	AppCfg parameter	Ethernet/IP object data option	Description	Initial value
MyAppCfg.Service	Service	Service code	Implement for class = Yes Implement for Instance = Yes Get attribute single	14 (0x0E in hexadecimal)
MyAppCfg.Class	Class	Class code	EtherNet/IP object class = Identity object	01
MyAppCfg.Instance	Instance	Instances	22-COMM-E	01
MyAppCfg.Attribute	Attribute	Instance attribute	Get product name and rating as SHORT STRING	07

## Add a MSG\_CIPGENERIC function block and variables

To add a MSG\_CIPGENERIC function block to a ladder diagram program and then add input variables to the function block, perform the following steps.

### To add a MSG\_CIPGENERIC function block:

1. Add a controller:
  - Expand the **Controllers** folder and the Micro850 folder to view all Micro850 controllers.
  - Double-click a controller (2080-LC50-48QVB) to add it to **Project Organizer**.
2. Add a ladder diagram program:
  - In **Project Organizer**, right-click **Programs**, click **Add**, and then click **New LD: Ladder Diagram**.



- Right-click the ladder diagram icon in **Project Organizer**, click **Rename** and type CIPExplicitMessage.
  - Double-click the ladder diagram program in **Project Organizer** to display the LD POU in the language editor.
3. Add the MSG\_CIPGENERIC function block:
    - In the **Toolbox**, select **Instruction Block** and drag and drop it onto the ladder rung to display the **Instruction Block Selector**.
    - In Search, type **MSG** to display the message function blocks.
    - Type **MSG\_ReadDrive** in the **Instance** field.
    - Double-click **MSG\_CIPGENERIC** to add an instance of the function block to the ladder diagram.
  4. Add MSG\_CIPGENERIC local input variables:
    - In **Project Organizer**, double-click **Local Variables** to display the **Local Variables** page.
    - In the **Variables** page, add the variables and data types listed in the table.

Parameter	Variable Name	Data Type
CtrlCfg	MyCtrlCfg	CIPCONTROLCFG
AppCfg	MyAppCfg	CIPAPPCFG
TargetCfg	MyTargetCfg	CIPTARGETCFG
ReqData	MyReqData	USINT
ReqLength	MyReqLength	UINT
ResData	MyResData	USINT (array)

5. For the MyResData variable, double click **Dimension** and change the array size to [1..81].

The **Variables** page should look similar to the following image.

Name	Alias	Data Type	Dimension	Project Value	Initial Value
MSG_ReadDrive		MSG_CIPGENERIC		...	...
MyCtrlCfg		CIPCONTROLCFG		...	...
MyAppCfg		CIPAPPCFG		...	...
MyTargetCfg		CIPTARGETCFG		...	...
MyReqData		USINT			
MyReqLength		UINT			
MyResData		USINT	[1..81]	...	...

## Configure initial values for variables

Follow these steps to add initial values to the input variables you previously created and then assign the variables to the correct MSG\_CIPGENERIC function block input parameter.

### To assign variables to MSG\_CIPGENERIC:

1. To configure initial values for the MyCtrlCfg input variable:
  - From the **Local Variables** page, expand MyCtrlCfg to view its parameters.

- Enter the following values in the **Initial Value** column for each parameter.

Parameter	Initial value	Comments
MyCtrlCfg.Cancel	Leave blank	Not needed.
MyCtrlCfg.TriggerType	0	We only need to retrieve the catalog number once.
MyCtrlCfg.StrMode	Leave blank	Not needed.

2. To configure initial values for the MyAppCfg input variable

- From the **Local Variables** page, expand MyAppCfg to view its parameters.
- Enter the following values in the **Initial Value** column for each parameter.

Parameter	Initial value
MyAppCfg.Service	14
MyAppCfg.Class	01
MyAppCfg.Instance	01
MyAppCfg.Attribute	07

3. To configure initial values for the MyTargetCfg input variable

- From the **Local Variables** page, expand MyTargetCfg to view its parameters.
- Enter the following values in the **Initial Value** column for each parameter.

Parameter	Initial Value	Comments
MyTargetCfg.Path	'4,192.168.100.4'	The first '4' indicates the message is being sent out of the embedded Ethernet port. 192.168.100.4 is the IP address of the drive Ethernet interface.
MyTargetCfg.CipConnMode	0	Unconnected is preferred for CIP messages.
MyTargetCfg.UcmmTimeout	blank	Unconnected messages have a timeout default of 3000 milliseconds if their Initial Values are blank.
MyTargetCfg.ConnMsgTimeout	blank	Connected messages have a timeout default of 3000 milliseconds if their Initial Values are blank.
MyTargetCfg.ConnClose	FALSE	For Connected messaging, the CIP connection could be closed immediately after completion of the message instruction by setting the Initial Value to TRUE.

The parameters in the **Variables** page should look similar to the following image.

Name	Alias	Data Type	Dimension	Project Value	Initial Value
MSG_ReadDrive		MSG_CIPGENERIC		...	...
MyCtrlCfg		CIPCONTROLCFG		...	...
MyCtrlCfg.Cancel		BOOL			
MyCtrlCfg.TriggerType		UDINT			0
MyCtrlCfg.StrMode		USINT			
MyAppCfg		CIPAPPCFG		...	...
MyAppCfg.Service		USINT			14
MyAppCfg.Class		UINT			01
MyAppCfg.Instance		UDINT			01
MyAppCfg.Attribute		UINT			07
MyAppCfg.MemberCnt		USINT			
MyAppCfg.MemberId		CIPMEMBERID		...	...
MyTargetCfg		CIPTARGETCFG		...	...
MyTargetCfg.Path		STRING			'4,192.168.100.4'
MyTargetCfg.CipConnMode		USINT			0
MyTargetCfg.UcmmTimeout		UDINT			
MyTargetCfg.ConnMsgTime		UDINT			
MyTargetCfg.ConnClose		BOOL			FALSE
MyReqData		USINT			
MyReqLength		UINT			
MyResData		USINT	[1..81]	...	...
MyResData[1]		USINT			

- To assign the variables to the parameters
  - In the ladder diagram POU, click the top portion of the variable input block to display the variable drop-down list.
  - From the list, assign each input parameter to its correct input variable as identified in the following table.

Parameter	Input variable	Comments
CtrlCfg	MyCtrlCfg	The catalog number must only be retrieved one time so the MyCtrlCfg.TriggerType initial value is set to 0.
AppCfg	MyAppCfg	The initial values were determined by looking up the object data values for Service, Class, Instance and Attribute.
Target	MyTargetCfg	The initial values are for target device configuration.
ReqData	MyReqData	Because this is a Read message, there is no request data so the ReqData parameters is not used.
ReqLength	MyReqLength	Because this is a Read message, there is no request data so the ReqLength parameters is not used.
ResData	MyResData	The catalog number string is stored in the array in the ODVA short string format. The first array element defines the strength length and the rest store the string character's hexadecimal value. The maximum number of characters is 80, plus the length element so MyResData is defined as a 1 dimension array with 81 elements.

The instance of the MSG\_CIPGENERIC function block should look similar to the following image.

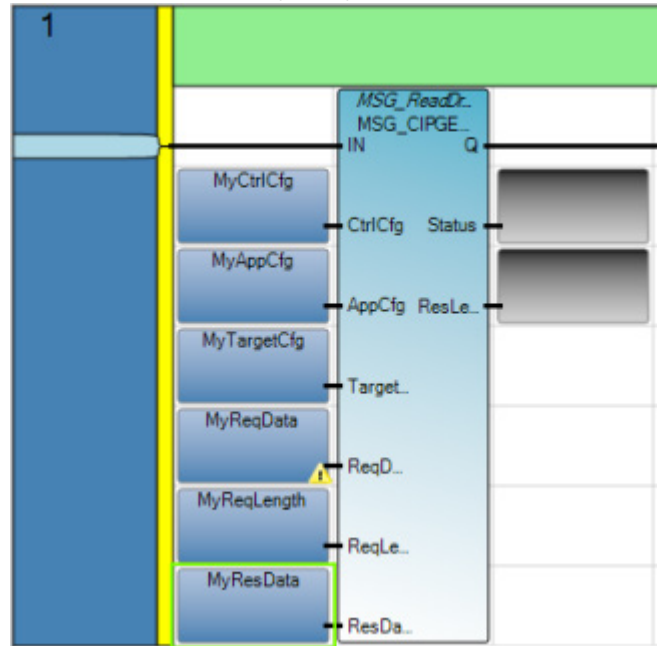

### Add a contact and a coil

Use the following steps to add a coil and a contact to the MSG\_CIPGENERIC instruction that converts the catalog information to a human readable string.

#### To add a coil to MSG\_CIPGENERIC:

1. In the **Toolbox**, select **Direct Contact** and drag and drop it to the left of the MSG\_CIPGENERIC function block input on the first ladder rung.
2. In the **Variable Selector**, type **Get\_Catalog** in the Name field for the contact.
3. In the **Toolbox**, select **Direct Coil** and drag and drop it to the right of the MSG\_CIPGENERIC function block output on the first ladder rung.
4. In the **Variable Selector**, type **Convert\_String** in the Name field for the coil.

The first rung of your ladder diagram program for MSG\_CIPGENERIC messaging should look similar to the following image.

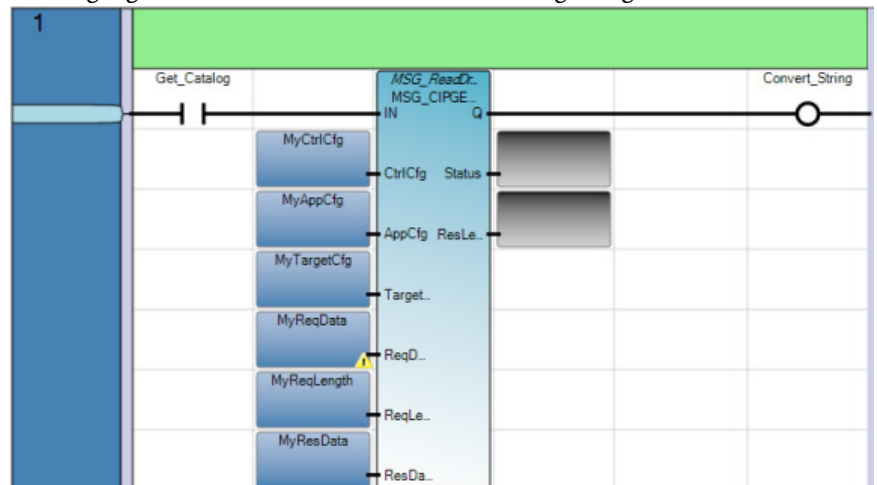

## Add a COP function block, variables and contact (MSG\_CIPGENERIC)

Use the following steps to add a COP function block, variables and a contact. The COP instruction is used to convert data from the source data type (for example, DINT or REAL) to the destination data type. In this example, the catalog information is converted to a human readable string.

### To add a COP function block:

1. In the **Toolbox**, select **Rung** and drag and drop it directly under the first ladder rung to add a second rung.
2. Add the COP function block:
  - In the **Toolbox**, select **Block** and drag and drop it onto the second ladder rung to open the **Instruction Block Selector**.
  - Double-click **COP** to add an instance of the function block to the ladder diagram.
3. Add local input variables for COP:
  - In **Project Organizer**, double-click **Local Variables** to display the **Local Variables** page.
  - In the **Local Variables** page, add the variables and data types listed in the following table.

Parameter	Variable name	Data type
Src	MyResData	Array USINT
SrcOffset	0	UINT
Dest	CatalogID	Array STRING
DestOffset	0	UINT
Length	1	UINT
Swap	FALSE	BOOLEAN

4. For the CatalogID variable, double click **Dimension** and change the array size to [1..1]
5. Add a contact:
  - In the **Toolbox**, select **Direct Contact** and drag and drop it to the left of the COP function block input on the second ladder rung.
  - In the **Variable Selector**, select the **Convert\_String** variable for the contact.

### Result

The second rung of your ladder diagram program for MSG\_CIPGENERIC messaging should look similar to the following image.

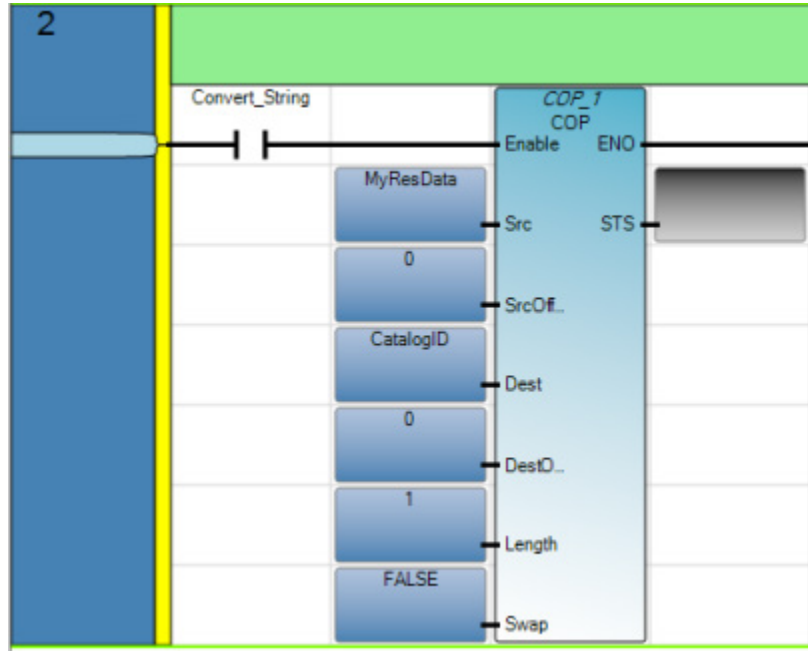

## Verify correct IP configuration on Controller B

Follow these steps to verify the IP address settings are correct on Controller B.

### To verify the IP address:

1. Open the application workspace for the controller:
2. In **Project Organizer**, double-click the controller to open the controller workspace.
3. In the controller workspace, expand **Ethernet** in the **Controller** tree and then click Internet Protocol to display the controller configuration page.
4. Verify the IP address settings are correct as identified in the following table.

IP configuration option	Value
IP address	192.168.1.19
Subnet Mask	255.255.255.0
Gateway address	192.168.1.1

### Results

The Internet Protocol options in your controller configuration page should look similar to the following image.

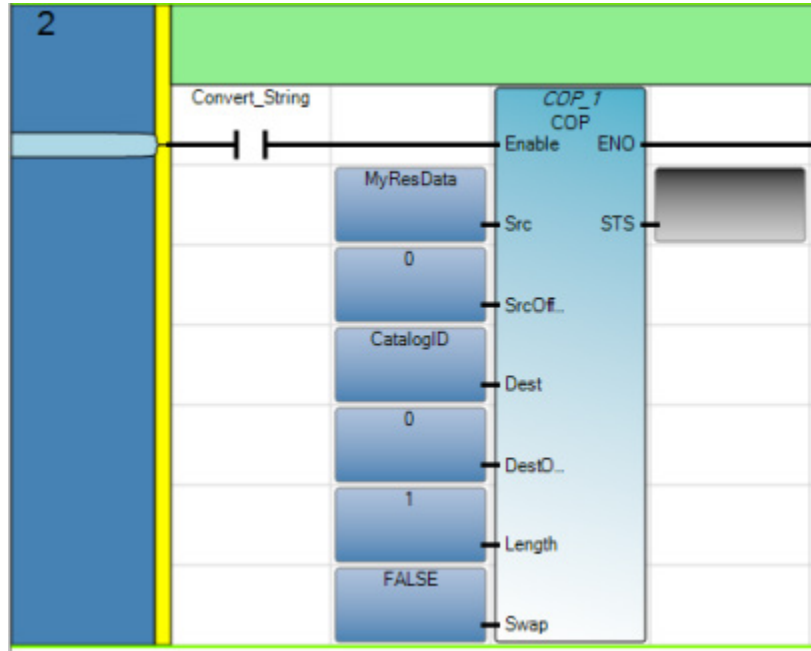

**Example: How to create an MSG\_CIPSYMBOLIC messaging program to write a value to a variable**

This example shows how to create a message program to write a value to a Controller B global variable from Controller A.

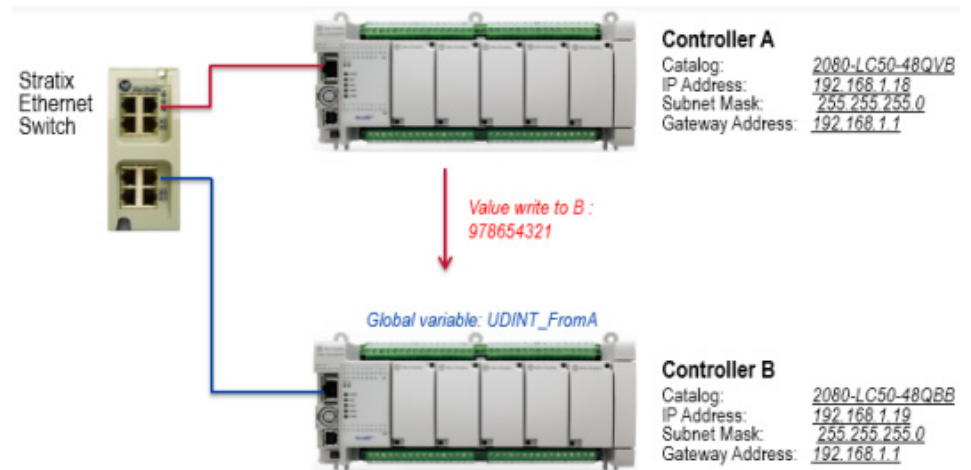

To create a MSG\_CIPSYMBOLIC messaging program used to write a value to a global variable on another controller, perform the following tasks.

No	Task
1	<a href="#">Add a COP function block, variables, and a contact (MSG_CIPSYMBOLIC) on page 224</a>
2	<a href="#">Add an Equal operator and a coil on page 225</a>
3	<a href="#">Add a MSG_CIPSYMBOLIC function block, variables and a contact on page 226</a>
4	<a href="#">Verify correct IP configuration on Controller B on page 222</a>
5	<a href="#">Create global variable for Controller B on page 229</a>
6	<a href="#">Review the complete program results on page 229</a>

## Add a COP function block, variables and a contact (MSG\_CIPSYMBOLIC)

The COP instruction is used to convert the data you enter to the destination data type so the data is compatible with the controller variable.

### To add a COP function block:

1. Add a controller:
  - Expand the **Controllers** folder and the Micro850 folder to view all Micro850 controllers.
  - Double-click a controller (2080-LC50-48QVB) to add it to **Project Organizer**.
2. Add a ladder diagram program:
  - In **Project Organizer**, right-click **Programs**, click **Add**, and then click **New LD: Ladder Diagram**.
  - Right-click the ladder diagram icon in **Project Organizer**, click **Rename** and type **CIPSymbolicMessage**.
  - Double-click the ladder diagram program in **Project Organizer** to display the LD POU in the language editor.
3. Add a COP function block:
  - In the **Toolbox**, select **Instruction Block** and drag and drop it onto the first ladder rung to open the **Instruction Block Selector**.
  - In Search, type **COP**, and double-click **COP** to add an instance of the function block to the ladder diagram.
4. Add COP variables and initial values:
  - In the ladder diagram POU, double-click **Local Variables** to open the **Local Variables** page.
  - In the **Variables** page, add the variables and data types listed in the table below.
5. Create Arrays:
  - For ValueToWrite, double-click **Dimension** and change the array size to [1..1].
  - For A\_Data, double-click **Dimension** and change the array size to [1..4].
6. Enter the data from the **Value** column of the table below into the **Initial Value** field for each variable.
7. Add a contact:
  - In the **Toolbox**, select **Direct Contact** and drag and drop it to the left of the COP function block input on the first ladder rung.
  - In the **Variable Selector**, assign a variable named **Convert\_Data** to contact.

Use the variables defined in the table for the COP function block.

Parameter	Variable name	Data type
-----------	---------------	-----------



Parameter	Variable name	Data type
Src	ValueToWrite	Array UDINT Initial value: 987654321
SrcOffset	0	UINT
Dest	A_Data	Array USINT
DestOffset	0	UINT
Length	4	UINT
Swap	TRUE	BOOLEAN
STS	COPsts	Array UINT

The first rung of your ladder diagram program for MSG\_CIPSYMBOLIC messaging should look similar to the following image.

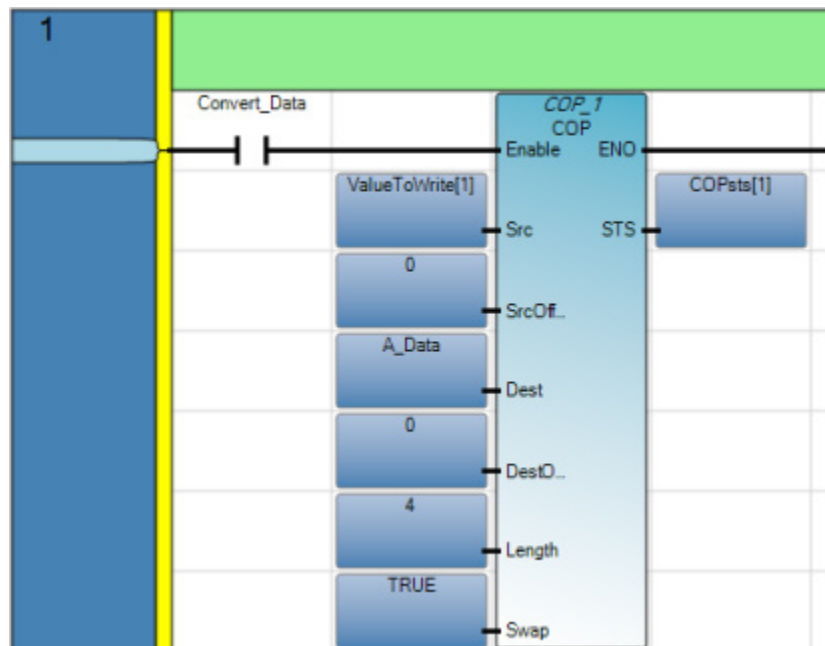

## Add an Equal operator and a coil

The Equal instruction is used to trigger writing a value if the data type conversion was successful. To add an Equal (=) operator, variables and a coil, perform the following steps.

### To add an Equal operator:

1. In the **Toolbox**, select **Rung** and drag and drop it directly under the first ladder rung to add a second rung.
2. Add an Equal operator:
  - In the **Toolbox**, select **Instruction Block** and drag and drop it onto the second ladder rung to open the **Instruction Block Selector**.
  - In Search, type the '=' sign and double-click '=' to add an instance of the operator to the ladder diagram.
3. To add Equal variables:
  - In the ladder diagram POU, double-click a variable to display the **Variable Selector**.

- In the **Variable Selector**, assign variable names as listed in the following table.

Parameter	Variable name
i1	COPsts
i2	1

4. To add a coil to the Equal operator:

In the **Toolbox**, select **Direct Coil** and drag and drop it to the right of the Equal operator output on the second ladder rung.

In the **Variable Selector**, type **WriteValue** in the Name field for the coil.

The second rung of your ladder diagram program for MSG\_CIPGENERIC messaging should look similar to the following image.

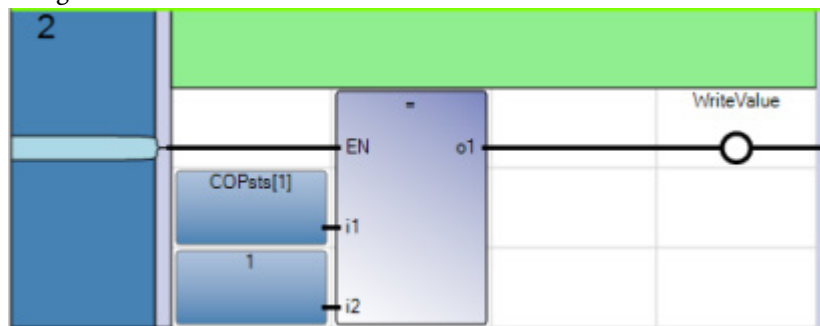

## Add a MSG\_CIPSYMBOLIC function block, variables and a contact

To add a MSG\_CIPSYMBOLIC function block, input variables and a contact to a ladder diagram, perform the following steps.

### To add function block and variables:

1. In the **Toolbox**, select **Rung** and drag and drop it directly under the second ladder rung to add a third rung.
2. Add the MSG\_CIPSYMBOLIC function block:
  - In the **Toolbox**, select **Instruction Block** and drag and drop it onto the ladder rung to display the **Instruction Block Selector**.
  - In Search, type **MSG** to display the message function blocks.
  - Type **MSG\_WriteVariable** in the **Instance** field.
  - Double-click **MSG\_CIPSYMBOLIC** to add an instance of the function block called MSG\_WriteVariable to the ladder diagram.
3. Assign variable names:
  - In the ladder diagram POU, double-click a variable to display the **Variable Selector**.
  - In the **Variable Selector**, assign variable names as listed in the following table.
4. For the Data variable, double click **Dimension** and change the array size to [1...4].
5. Configure initial values for the local variables, add CtrlCfg initial values:

- From the **Local Variables** page, expand the CtrlCfg parameter to view additional parameters.
- Enter the following values in the Initial Value column for each parameter.

Parameter	Initial value
A_CtrlCfg.Cancel	Leave blank
A_CtrlCfg.TriggerType	300
A_CtrlCfg.StrMode	Leave blank

6. Add SymCfg initial values:

- From the **Local Variables** page, expand the SymCfg parameter to view additional parameters.
- Enter the following values in the Initial Value column for each parameter.

Parameter	Initial value
A_SymCfg.Service	1
A_SymCfg.Symbol	'UDINT_FromA'
A_SymCfg.Count	Leave blank
A_SymCfg.DataType	200
A_SymCfg.Offset	Leave blank

The Local Variables selector should look similar to the following image.

Name	Alias	Data Type	Dimension	Project Value	Initial Value
MSG_CIPSYMBOLIC_1		MSG_CIPSYMBOL		...	...
A_CtrlCfg		CIPCONTROLCFG		...	...
A_CtrlCfg.Cancel		BOOL			
A_CtrlCfg.TriggerType		UDINT			300
A_CtrlCfg.StrMode		USINT			
A_SymCfg		CIPSYMBOLICCFG		...	...
A_SymCfg.Service		USINT			1
A_SymCfg.Symbol		STRING			'UDINT_FromA'
A_SymCfg.Count		UINT			
A_SymCfg.DataType		USINT			200
A_SymCfg.Offset		USINT			

7. Configure initial values for TargetCfg

- From the ladder diagram POU, double-click the A\_TarCfg variable to open the global variables selector.
- Expand the TargetCfg parameter to view additional parameters.
- Enter the following values in the Initial Value column for each parameter.

Parameter	Initial value
A_TarCfg.Path	'4,192.168.1.19'
A_TarCfg.CipConnMode	1
A_TarCfg.UcmmTimeout	0
A_TarCfg.ConnMsgTimeout	0
A_TarCfg.ConnClose	Leave blank

The User Global Variables selector should similar to the following image.

Name	Alias	Data Type	Dimension	Project Value	Initial Value
A_TarCfg		CIPTARG		...	...
A_TarCfg.Path		STRING		'4,192.168.1.19'	
A_TarCfg.CipConnMode		USINT		1	
A_TarCfg.UcmmTimeout		UDINT		0	
A_TarCfg.ConnMsgTimeout		UDINT		0	
A_TarCfg.ConnClose		BOOL			

8. Add a contact:

- In the **Toolbox**, select **Direct Contact** and drag and drop it to the left of the MSG\_CIPSYMBOLIC function block input on the third ladder rung.
- In the **Variable Selector**, assign the **WriteValue** variable to the contact.

The third rung of your ladder diagram program for MSG\_CIPSYMBOLIC messaging should look similar to the following image.

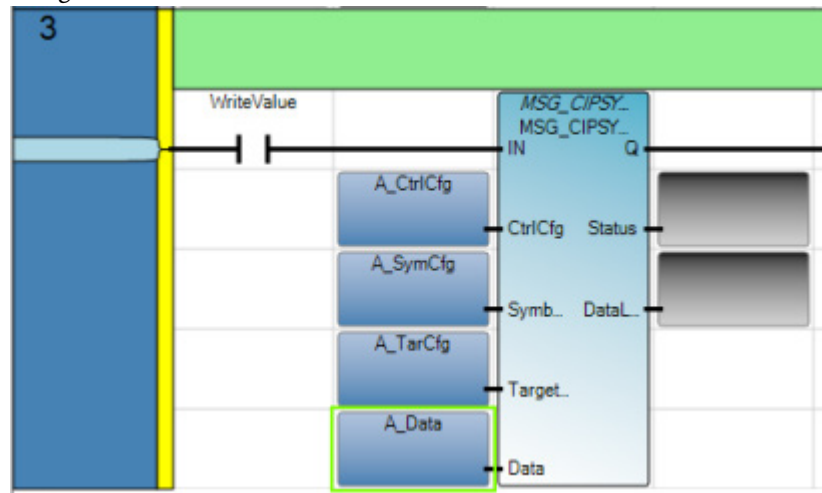

## Verify correct IP configuration on Controller B

Follow these steps to verify the IP address settings are correct on Controller B.

### To verify the IP address:

1. Open the application workspace for the controller:
2. In **Project Organizer**, double-click the controller to open the controller workspace.
3. In the controller workspace, expand **Ethernet** in the **Controller** tree and then click Internet Protocol to display the controller configuration page.
4. Verify the IP address settings are correct as identified in the following table.

IP configuration option	Value
-------------------------	-------

IP address	192.168.1.19
Subnet Mask	255.255.255.0
Gateway address	192.168.1.1

**Results**

The Internet Protocol options in your controller configuration page should look similar to the following image.

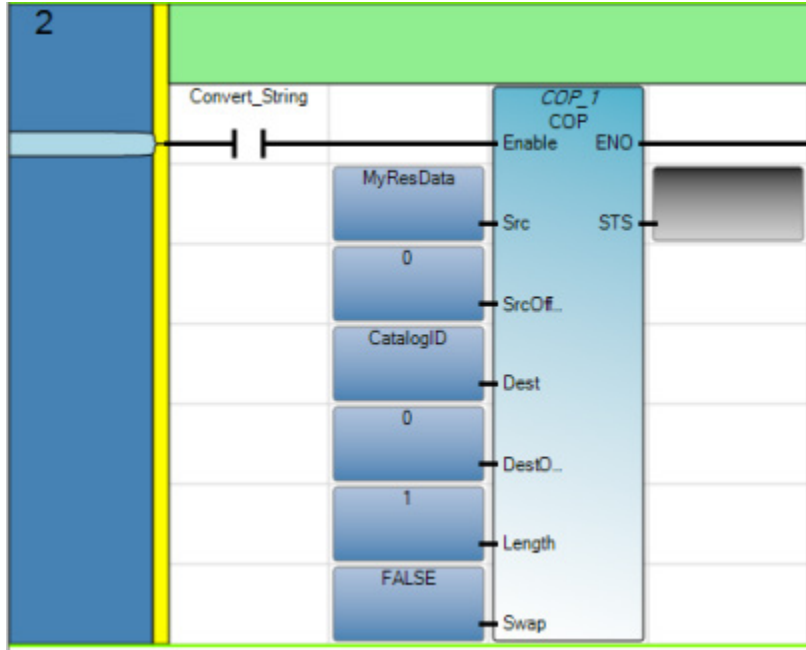

**Create global variable for Controller B**

Follow these steps to create a Global variable for controller B.

**To create a Global variable:**

1. In **Project Organizer**, double-click **Global Variables** to display the **Global Variables** selector.
2. Type UDINT\_FromA in the **Name** column.
3. Configure the remaining parameters:
  - Verify the data type is UDINT.
  - Verify the **Read/Write** attribute is selected.

The **Global Variables** selector should look similar to the following image.

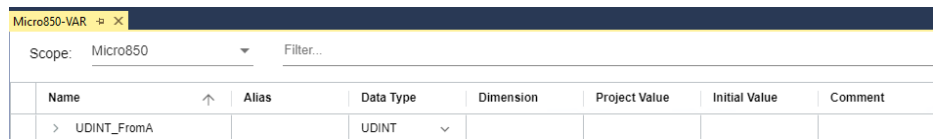

**Review the complete program results**

The following example shows the complete MSG\_CIPSYMBOLIC messaging program after it has executed.

The screenshot displays the Rockwell Automation software interface. On the left, the Project Organizer shows a project named 'QS\_CIPG\_CtrB' with a device 'Micro850'. The main window shows the 'Scope: Micro850' and a table of variables:

Name	Logical Value	Physical Value
> UDINT_FromA	0	N/A
_IO_EM_DI_00	<input type="checkbox"/>	<input type="checkbox"/>
_IO_EM_DI_01	<input type="checkbox"/>	<input type="checkbox"/>
_IO_EM_DI_02	<input type="checkbox"/>	<input type="checkbox"/>
_IO_EM_DI_03	<input type="checkbox"/>	<input type="checkbox"/>

Below the table, the 'WriteTab-POU' window shows a ladder logic diagram. The first rung, labeled 'ConvertData', contains a 'COP 7 COP' instruction. Its inputs are: 'Enable' (TRUE), 'Src' (ValueToWrite: 12754321), 'SrcOffset' (0), 'Dest' (A\_Data: 177), 'DestOffset' (0), 'Length' (4), and 'Temp' (TRUE). The output is 'STS' (COPSta: 1). The second rung contains an 'EN' (COPSta: 1) and an 'o1' instruction. The third rung, labeled 'WriteValue', contains an 'MSG CPSYMBOLIC 7 MSG CPSYMBOLIC' instruction. Its inputs are: 'IN' (A\_ChoClt: False), 'CxtClt' (A\_SymClt: 1), 'SymbolClt' (A\_TarClt: 4182185118), and 'Data' (A\_Data: 177). The outputs are 'Status' (False) and 'DataLength' (0).

### Controller B results

The following two images show the values for Controller B before and after the messaging program is executed.

### Before the program executes

The screenshot shows the Project Organizer with the scope set to Micro850. The table below represents the data shown in the interface:

Name	Logical Value	Physical Value
> UDINT_FromA	0	N/A
_IO_EM_DI_00	<input type="checkbox"/>	<input type="checkbox"/>
_IO_EM_DI_01	<input type="checkbox"/>	<input type="checkbox"/>
_IO_EM_DI_02	<input type="checkbox"/>	<input type="checkbox"/>
_IO_EM_DI_03	<input type="checkbox"/>	<input type="checkbox"/>

### After the program executes

The screenshot shows the Project Organizer with the scope set to Micro850. The table below represents the data shown in the interface:

Name	Logical Value	Physical Value
> UDINT_FromA	987654321	N/A
_IO_EM_DI_00	<input type="checkbox"/>	<input type="checkbox"/>
_IO_EM_DI_01	<input type="checkbox"/>	<input type="checkbox"/>
_IO_EM_DI_02	<input type="checkbox"/>	<input type="checkbox"/>
_IO_EM_DI_03	<input type="checkbox"/>	<input type="checkbox"/>
_IO_EM_DI_04	<input type="checkbox"/>	<input type="checkbox"/>

### Example: How to configure Modbus communication to read from and write to a drive

These examples describe how to configure Modbus communication to read status data from and write control data to a PowerFlex 4 drive using the [MSG\\_MODBUS](#) on [page 177](#) instruction.

### Micro830 wiring

This example uses a Micro830 controller with a SERIALISOL module plugged into the first slot (Channel 5). A single PowerFlex 40 is connected, but the diagram below shows how to wire for multi-drop. Refer to the user manual for additional wiring information.

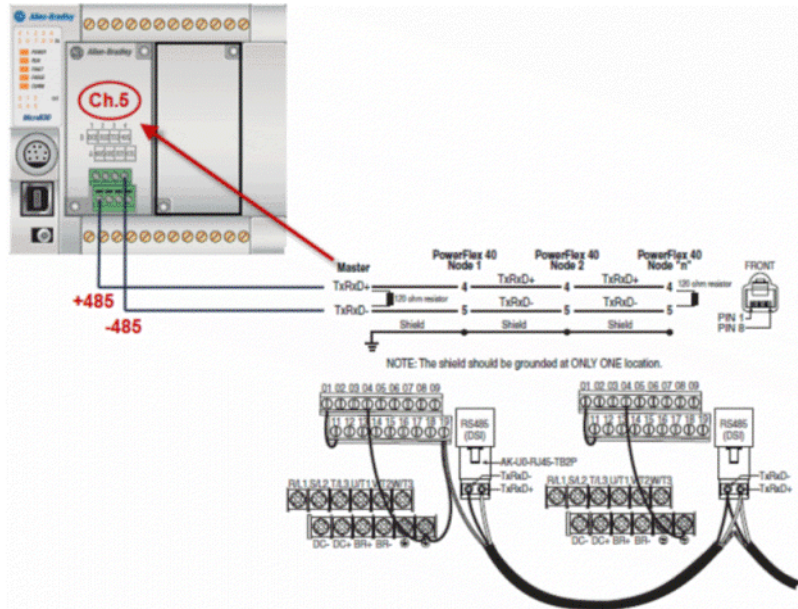

AK-U0-RJ45-TB2P is an RJ45 connector with 2 terminal blocks for RS485 communications

### Modbus Read example

The following MSG\_MODBUS instruction can be used to read status data from the PowerFlex 40 drive.

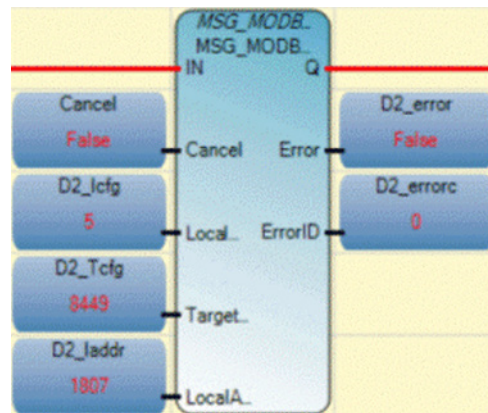

### Drive status

An "1807" indicates the drive is

- Ready (bit 0 ON),
- Active (bit 1 ON)
- Commanded Forward (bit 2 ON)
- Rotating Forward (bit 3 ON)



- Status of some digital inputs on the drive

A "278" indicates 27.8Hz.

Refer to the PowerFlex user manual for additional information about Logic Status word bits, error code descriptions, commanded and actual speeds, and other status codes.

### MSG\_MODBUS Read configuration

The following image shows the variable options for the MSG\_MODBUS instruction block used to read status data from a PowerFlex 40 drive.

	Name	Data Type	Direction	Dimension
+	MSG_MODBUS_1	MSG_MODI	Var	
-	D2_lcfg	MODBUSLC	Var	
	D2_lcfg.Channel	UINT	Var	
	D2_lcfg.TriggerType	USINT	Var	
	D2_lcfg.Cmd	USINT	Var	
	D2_lcfg.ElementCnt	UINT	Var	
-	D2_Tcfg	MODBUSF#	Var	
	D2_Tcfg.Addr	UDINT	Var	
	D2_Tcfg.Node	USINT	Var	
▶	D2_laddr	MODBUSLC	Var	
	D2_laddr[1]	WORD	Var	
	D2_laddr[2]	WORD	Var	
	D2_laddr[3]	WORD	Var	
	D2_laddr[4]	WORD	Var	
	D2_laddr[5]	WORD	Var	

### MSG\_MODBUS Read variables

The following table identifies the variables and the values used to configure the MSG\_MODBUS instruction to read status data from a PowerFlex 4 drive.

Variable	Value	Description
*.Channel	5	Channel 5 - location of SERIALISOL module
*.TriggerType	0	Trigger on False-to-True transition
*.Cmd	3	Modbus Function Code "03" - Read Holding Registers
*.ElementCnt	4	Length
*.Addr	8449	PowerFlex Logic Status word address + 1
*.Node	2	PowerFlex Node address
*_laddr[1]	{data}	PowerFlex Logic Status word
*_laddr[2]	{data}	PowerFlex Error Code
*_laddr[3]	{data}	PowerFlex Commanded Speed (Speed Reference)
*_laddr[4]	{data}	PowerFlex Speed Feedback (Actual Speed)

### MOV instruction example

The following images shows an example of using the MOV instruction to move the \*\_I[1] array value to a Word, which allows you to directly access the individual bits.

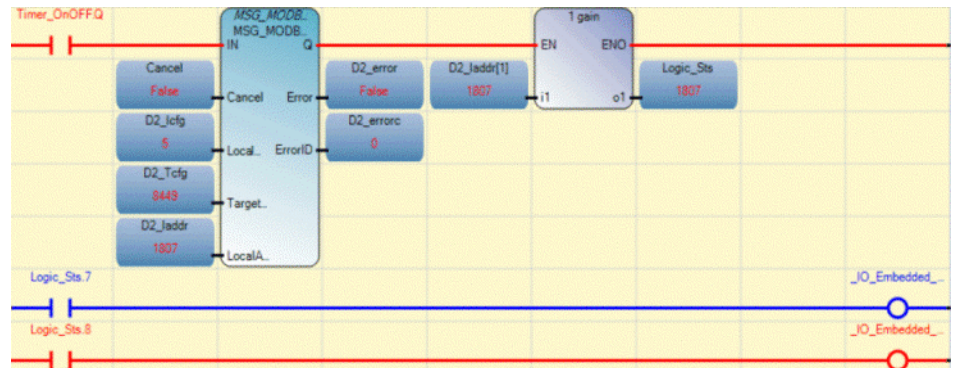

### Modbus Write example

The following MSG\_MODBUS instruction is used to write control data to a PowerFlex 40 drive.

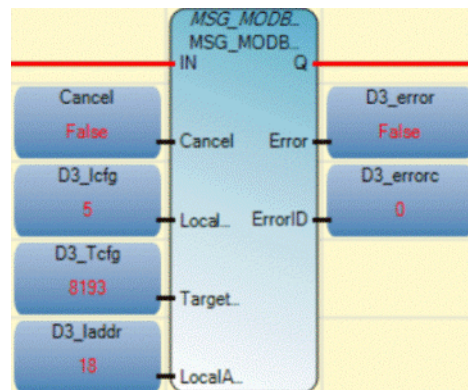

### MSG\_MODBUS Write configuration

The following image shows the variables and the values used to configure the MSG\_MODBUS instruction to write control data to a PowerFlex 4 drive.

Name	Data Type	Direction	Dimension
D3_Jcfg	MODBUSLC	Var	
D3_Jcfg.Channel	UINT	Var	
D3_Jcfg.TriggerType	USINT	Var	
D3_Jcfg.Cmd	USINT	Var	
D3_Jcfg.ElementCnt	UINT	Var	
D3_Tcfg	MODBUST/	Var	
D3_Tcfg.Addr	UDINT	Var	
D3_Tcfg.Node	USINT	Var	
D3_Jaddr	MODBUSLC	Var	
D3_Jaddr[1]	WORD	Var	
D3_Jaddr[2]	WORD	Var	
D3_Jaddr[3]	WORD	Var	

### MSG\_MODBUS Write variables

The following table lists the variables, values and describes the purpose of each variable.

Variable	Value	Description
*.Channel	5	Channel 5 - location of SERIALISOL module
*.TriggerType	0	Trigger on False-to-True transition
*.Cmd	16	Modbus Function Code "16" - Write Holding Registers
*.ElementCnt	2	Length
*.Addr	8193	PowerFlex Logic Status word address + 1
*.Node	2	PowerFlex Node address
*_laddr[1]	{data}	PowerFlex Logic Command word
*_laddr[2]	{data}	PowerFlex Speed Reference word

### Communication protocol support

The MSG\_CIP function blocks support different communication protocols as described in this section.

Function block support for message communication protocols.

Messaging Protocol	Communication media	Use this function block
Modbus/RTU client and server	Through a Serial port configured as Modbus RTU.	<a href="#">MSG_MODBUS</a> on <a href="#">page 177</a>
Modbus/TCP client and server	Over the Ethernet instead of through a serial port.	<a href="#">MSG_MODBUS2</a> on <a href="#">page 182</a>
Ethernet IP client and server	Through an embedded Ethernet channel.	<a href="#">MSG_CIPSYMBOLIC</a> on <a href="#">page 173</a> <a href="#">MSG_CIPGENERIC</a> on <a href="#">page 165</a>
CIP Serial client and server	Ethernet cable or Serial cable.	<a href="#">MSG_CIPSYMBOLIC</a> on <a href="#">page 173</a>

ASCII	Through an RS-232 port configured with an ASCII driver.	See <a href="#">ASCII serial port instructions</a> on <a href="#">page 105</a> .
-------	---	--

## Modbus RTU

Modbus is a half-duplex, master-slave communications protocol that allows a single master to communicate with a maximum of 247 slave devices. The Modbus network master reads and writes bits and registers. Modbus RTU is supported by configuring the Serial port as Modbus RTU.

For more information about the Modbus protocol, refer to the Modbus Protocol Specifications (available from <http://www.modbus.org>).

## Modbus/TCP

The Modbus/TCP Server communication protocol uses the same Modbus mapping features as Modbus RTU, but it is supported over the Ethernet instead of through a Serial port.

The Micro850 controller supports up to 16 simultaneous Modbus TCP Server connections. No protocol configuration is required other than configuring the Modbus mapping table.

## EtherNet/IP

Micro820 and Micro850 controllers support up to 16 simultaneous EtherNet/IP server connections through an [embedded Ethernet communication channel](#) on [page 237](#). The channel can be used to connect a Micro850 controller to various devices through a local area network using a 10 Mbps/100 Mbps transfer rate.

## Common Industrial Protocol (CIP)

The CIP protocol is a transport and application layer protocol used for messaging over EtherNet/IP, ControlNet, and DeviceNet networks that allows HMIs to easily connect to a Micro830 or a Micro850 controller.

### CIP explicit messaging

The CIP protocol is used for explicit messaging. Explicit Messaging (configuration, data collection, and diagnostics) is used to transfer data that does not require continuous updates. Explicit messaging is supported using CIP Generic client messaging through the MSG\_CIPGENERIC function block and using CIP Symbolic client messaging through the MSG\_CIPSYMBOLIC function block.

## CIP Serial

CIP serial uses DF1 Full Duplex protocol, and provides point-to-point connection between two devices. It combines data transparency (American National Standards Institute ANSI - X3.28-1976 specification subcategory D1) and 2-way simultaneous transmission with embedded responses (subcategory F1)

Micro830 and Micro850 controllers support CIP Serial through an RS-232 connection to external devices, such as computers running RSLinx Classic software, PanelView Component terminals (firmware revisions 1.70 and above), or other controllers that support CIP Serial over DF1 Full-Duplex, such as ControlLogix and CompactLogix controllers that have embedded serial ports.

The Serial Port driver can be configured as CIP Serial, Modbus RTU, ASCII or Shutdown through the device configuration tree.

## Embedded communication channels

The Micro820, Micro830, and Micro850 controllers have the following additional embedded communication channels:

- A non-isolated RS-232/485 combo port
- A non-isolated USB programming port (Micro830 and Micro850 only)
- An RJ-45 ethernet port (Micro820, and Micro850 only)



## Compare instructions

Use Compare instructions to compare Integer, Real, Time, Date, and String values using an expression or a specific compare instruction.

Instruction	Description
(=) <a href="#">Equal</a> on <a href="#">page 239</a> .	Compares the first input to the second input to determine equality. For Integer, Real, Time, Date, and String data types.
(>) <a href="#">Greater Than</a> on <a href="#">page 242</a> .	Compares input values to determine whether the first is greater than the second.
(>=) <a href="#">Greater Than or Equal</a> on <a href="#">page 244</a> .	Compares input values to determine whether the first is greater than or equal to the second.
(<) <a href="#">Less Than</a> on <a href="#">page 245</a> .	Compares input values to determine whether the first is less than the second.
(<=) <a href="#">Less Than or Equal</a> on <a href="#">page 247</a> .	Compare input values to determine whether the first is less than or equal to the second.
(<>) <a href="#">Not Equal</a> on <a href="#">page 247</a> .	Compares input values to determine whether the first is not equal to the second.

### Equal

Performs an operation that compares the first input to the second input to determine equality for Integer, Real, Time, Date, and String data types.

Operation details:

- Equality testing of Time values is not recommended for TON, TP, and TOF instruction blocks.
- The Real data type is not recommended when comparing values for equality because numbers in the math operation are rounded differently than those that appear in the variable output display. Consequently, two output values may appear equal in the display, though evaluate as false. For example, 23.500001 compared to 23.499999, both display as 23.5 in the variable input display, but are not equal in the controller.

Languages supported: Function Block Diagram, Ladder Diagram, Structured Text.

This instruction applies to the Micro810, Micro820, Micro830, Micro850, Micro870 controllers and Micro800 Simulator.

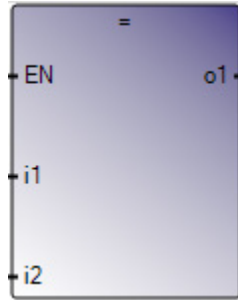

Use this table to help determine the parameter values for this instruction.

Parameter	Parameter Type	Data Type	Description
EN	Input	BOOL	Function enable. TRUE - execute the equality comparison. FALSE - there is no comparison. Applies only to Ladder Diagram programs.
i1	Input	BOOL SINT USINT BYTE INT UINT WORD DINT UDINT DWORD LINT ULINT LWORD REAL LREAL TIME DATE STRING	All inputs must be the same data type. The Time input applies to the Structured Text, Ladder Diagram and Function Block Diagram languages. The Real data type is not recommended.



Parameter	Parameter Type	Data Type	Description
i2	Input	BOOL SINT USINT BYTE INT UINT WORD DINT UDINT DWORD LINT ULINT LWORD REAL LREAL TIME DATE STRING	
o1	Output	BOOL	TRUE if i1 = i2.

### Compare Real Values using Subtraction (-) ABS, and Less than (<) example

The Real data type is not recommended when comparing values for equality because of differences in the way numbers are rounded. Two output values may appear equal in a Connected Components Workbench display, but will evaluate as false.

For example, 23.500001 compared to 23.499999 will both display as 23.5 in the variable input display, but will not be equal in the controller.

To test whether two Real data type values are equal, you can use a Subtraction instruction to get the difference between the values and then determine if the difference is Less Than an established precision value. See the following LD program example for comparing two Real data type values.

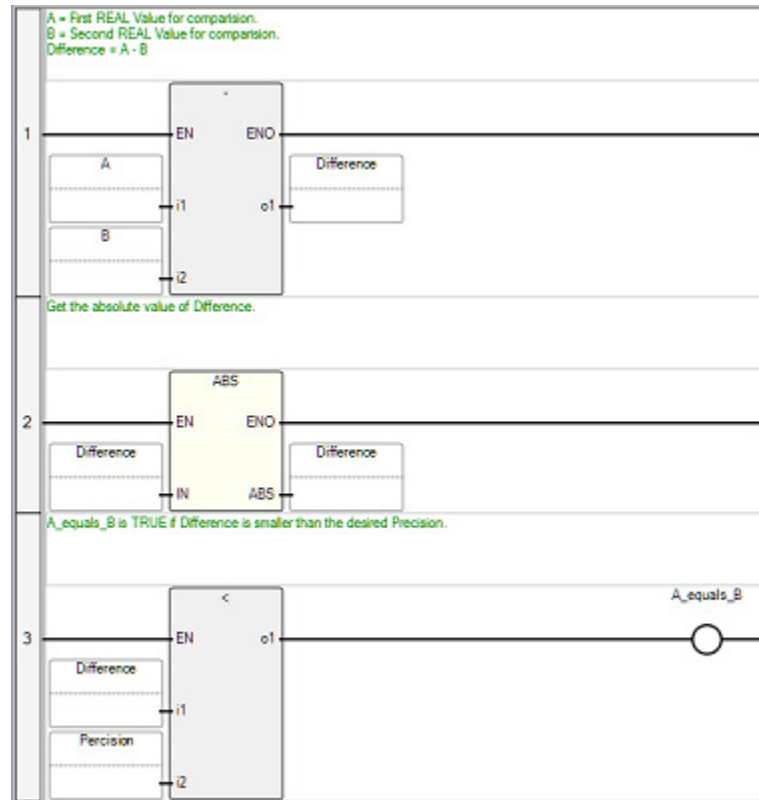

### Equal (=) Structured Text example

(\* ST Equivalence: \*)

```

result := (10 = 25); (* result is FALSE *)
mresult := ('ab' = 'ab'); (* mresult is TRUE *)
    
```

### Greater than

Compares Integer, Real, Time, Date, and String input values to determine whether the first is greater than the second.

Languages supported: Function Block Diagram, Ladder Diagram, Structured Text.

This instruction applies to the Micro810, Micro820, Micro830, Micro850, Micro870 controllers and Micro800 Simulator.

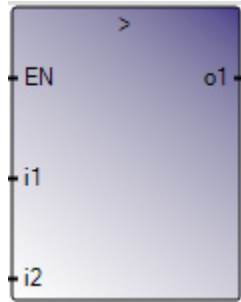

Use this table to help determine the parameter values for this instruction.

Parameter	Parameter Type	Data Type	Description
EN	Input	BOOL	Instruction enable. TRUE - execute the input comparison. FALSE -there is no comparison. Applies only to Ladder Diagram programs.
i1	Input	SINT USINT BYTE INT UINT WORD DINT UDINT DWORD LINT ULINT LWORD REAL LREAL TIME DATE STRING	All inputs must be the same data type.
i2	Input	SINT USINT - BYTE INT UINT WORD DINT UDINT DWORD LINT ULINT LWORD REAL LREAL TIME DATE STRING	

o1	Output	BOOL	TRUE if i1 > i2.
----	--------	------	------------------

### Greater than (>) Structured Text example

(\* ST Equivalence: \*)

```

result := (10 > 25); (* result is FALSE *)
mresult := ('ab' > 'a'); (* mresult is TRUE *)
    
```

### Greater than or equal

Compares Integer, Real, Time, Date, and String input values to determine whether the first is greater than or equal to the second.

For TON, TP, and TOF, equality testing of Time values is not recommended.

Languages supported: Function Block Diagram, Ladder Diagram, Structured Text.

This instruction applies to the Micro810, Micro820, Micro830, Micro850, Micro870 controllers and Micro800 Simulator.

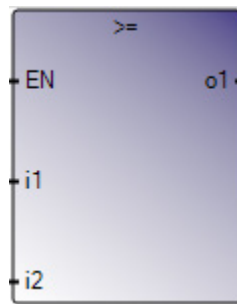

Use this table to help determine the parameter values for this instruction.

Parameter	Parameter Type	Data Type	Description
EN	Input	BOOL	Instruction enable. TRUE - execute the input comparison. FALSE - there is no comparison. Applies only to Ladder Diagram programs.
i1	Input	SINT USINT BYTE INT UINT WORD DINT UDINT DWORD LINT ULINT LWORD REAL LREAL TIME DATE STRING	All inputs must be the same data type. The Time input applies to the Structured Text, Ladder Diagram and Function Block Diagram languages.

i2	Input	SINT USINT BYTE INT UINT WORD DINT UDINT DWORD LINT ULINT LWORD REAL LREAL TIME DATE STRING	
o1	Output	BOOL	TRUE if i1 >= i2.

### Greater than or equal (>=) Structured Text example

(\* ST Equivalence: \*)

```

aresult := (10 >= 25); (* aresult is FALSE *)
mresult := ('ab' >= 'ab'); (* mresult is TRUE *)
    
```

### Less than

Compares Integer, Real, Time, Date, and String input values to determine whether the first is less than the second.

Languages supported: Function Block Diagram, Ladder Diagram, Structured Text.

This instruction applies to the Micro810, Micro820, Micro830, Micro850, Micro870 controllers and Micro800 Simulator.

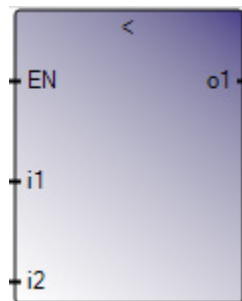

Use this table to help determine the parameter values for this instruction.

Parameter	Parameter Type	Data Type	Description
EN	Input	BOOL	Instruction enable. TRUE - execute the input comparison. FALSE - there is no comparison. Applies only to Ladder Diagram programs.

i1	Input	SINT USINT BYTE INT UINT WORD DINT UDINT DWORD LINT ULINT LWORD REAL LREAL TIME DATE STRING	All inputs must be the same data type.
i2	Input	SINT USINT BYTE INT UINT WORD DINT UDINT DWORD LINT ULINT LWORD REAL LREAL TIME DATE STRING	
o1	Output	BOOL	TRUE if i1 < i2.

### Less than (<) Structured Text example

(\* ST Equivalence: \*)

```

aresult := (10 < 25); (* aresult is TRUE *)
mresult := ('z' < 'B'); (* mresult is FALSE *)

```

(\* IL equivalence: \*)

LD	10
LT	25
ST	aresult
LD	'z'
LT	'B'
ST	mresult

## Less than or equal

Compares Integer, Real, Time, Date, and String input values to determine whether the first is less than or equal to the second.

For TON, TP, and TOF, equality testing of Time values is not recommended.

Languages supported: Function Block Diagram, Ladder Diagram, Structured Text.

This instruction applies to the Micro810, Micro820, Micro830, Micro850, Micro870 controllers and Micro800 Simulator.

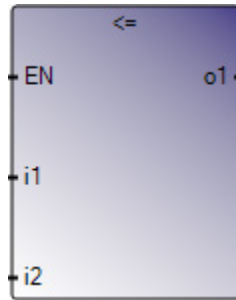

Use this table to help determine the parameter values for this instruction.

Parameter	Parameter Type	Data Type	Description
EN	Input	BOOL	Instruction enable. TRUE - execute the input comparison. FALSE - there is no comparison. Applies only to Ladder Diagram programs.
i1	Input	SINT - USINT - BYTE - INT - UINT - WORD - DINT - UDINT - DWORD - LINT - ULINT - LWORD - REAL - LREAL - TIME - DATE - STRING	All inputs must be the same data type. The Time input applies to the Structured Text, Ladder Diagram and Function Block Diagram languages.
i2	Input	SINT - USINT - BYTE - INT - UINT - WORD - DINT - UDINT - DWORD - LINT - ULINT - LWORD - REAL - LREAL - TIME - DATE - STRING	
o1	Output	BOOL	TRUE if i1 <= i2.

### Less than or equal (<=) Structured Text example

(\* ST Equivalence: \*)

```
aresult := (10 <= 25); (* aresult is TRUE *)
mresult := ('ab' <= 'ab'); (* mresult is TRUE *)
```

## Not equal

Compares Integer, Real, Time, Date, and String input values to determine whether the first is not equal to the second.

Languages supported: Function Block Diagram, Ladder Diagram, Structured Text.

This instruction applies to the Micro810, Micro820, Micro830, Micro850, Micro870 controllers and Micro800 Simulator.

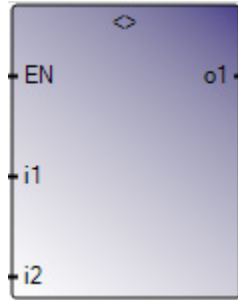

Use this table to help determine the parameter values for this instruction.

Parameter	Parameter Type	Data Type	Description
EN	Input	BOOL	Instruction enable. TRUE - execute current compare computation. FALSE - there is no computation. Applies only to Ladder Diagram programs.
i1	Input	BOOL SINT USINT BYTE INT UINT WORD DINT UDINT DWORD LINT ULINT LWORD REAL LREAL TIME DATE STRING	All inputs must be the same data type.



i2	Input	BOOL SINT USINT BYTE INT UINT WORD DINT UDINT DWORD LINT ULINT LWORD REAL LREAL TIME DATE STRING	
o1	Output	BOOL	TRUE - if first <> second.

### Not equal (<>) Structured Text example

(\* ST Equivalence: \*)

```

aresult := (10 <> 25); (* aresult is TRUE *)
mresult := ('ab' <> 'ab'); (* mresult is FALSE *)

```



## Counter instructions

Use Counter instructions to control operations based on the number of events.

Instruction	Description
<a href="#">CTD</a> on <a href="#">page 251</a>	Counts integers from a given value down to 0, 1 by 1.
<a href="#">CTU</a> on <a href="#">page 253</a>	Counts integers from 0 up to a given value, 1 by 1.
<a href="#">CTUD</a> on <a href="#">page 255</a>	Counts integers from 0 up to a given value, 1 by 1, or from a given value down to 0, 1 by 1.

### CTD (count down)

Counts integers from a given value down to 0, 1 by 1.

Languages supported: Function Block Diagram, Ladder Diagram, Structured Text.

This instruction applies to the Micro810, Micro820, Micro830, Micro850, Micro870 controllers and Micro800 Simulator.

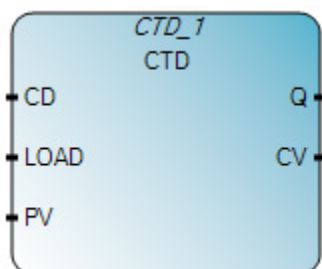

Use this table to help determine the parameter values for this instruction.

Parameter	Parameter Type	Data Type	Description
CD	Input	BOOL	Counts down. TRUE - Rising edge detected, count down in increments of one. FALSE - Falling edge detected, hold the counter value at the same value.
LOAD	Input	BOOL	Load verifies the PV value against the count down value. TRUE - set CV=PV. FALSE - Continue incrementing count down by one.
PV	Input	DINT	Programmed maximum value of the counter.
Q	Output	BOOL	Indicates whether the count down instruction has resulted in a number less than or equal to the maximum value of the counter. TRUE - Counter result $\leq 0$ (Underflow condition). FALSE - Counter result $> 0$ .
CV	Output	DINT	Current counter value.

### CTD Function Block Diagram example

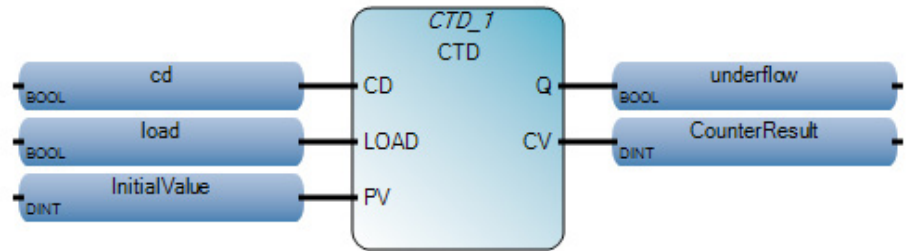

### CTD Ladder Diagram example

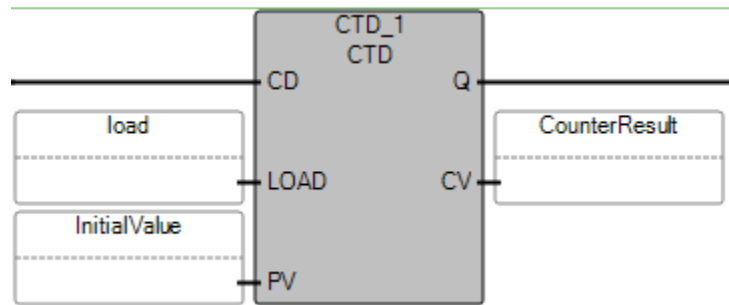

### CTD Structured Text example

```
CTD_1(
void CTD_1(BOOL CD, BOOL LOAD, DINT PV)
Type : CTD, Down counter
```

```
1: InitialValue := 10;
2: CTD_1(cd, load, InitialValue);

(*ST Equivalence: CTD1 is an instance of block *)
CTD1(trigger,load_cmd,100);
underflow := CTD1.Q;
result := CTD1.CV;
```

## Results

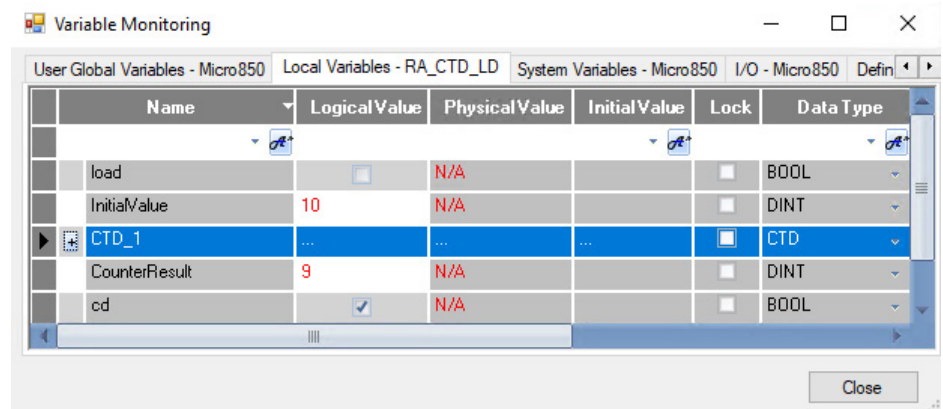

Name	Logical Value	Physical Value	Initial Value	Lock	Data Type
load	<input type="checkbox"/>	N/A		<input type="checkbox"/>	BOOL
InitialValue	10	N/A		<input type="checkbox"/>	DINT
CTD_1	...	...	...	<input type="checkbox"/>	CTD
CounterResult	9	N/A		<input type="checkbox"/>	DINT
cd	<input checked="" type="checkbox"/>	N/A		<input type="checkbox"/>	BOOL

## CTU (count up)

CTU counts (integers) from 0 up to a given value, 1 by 1.

Languages supported: Function Block Diagram, Ladder Diagram, Structured Text.

This instruction applies to the Micro810, Micro820, Micro830, Micro850, Micro870 controllers and Micro800 Simulator.

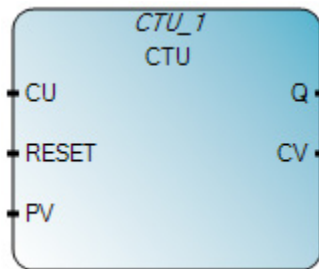

Use this table to help determine the parameter values for this instruction.

Parameter	Parameter Type	Data Type	Description
CU	Input	BOOL	Counts upward. TRUE - Rising edge detected, count upward in increments of one. FALSE - Falling edge detected, hold the counter value at the same value.
RESET	Input	BOOL	Reset verifies the PV value against the count upward value. TRUE - set the CV value to zero. FALSE - Continue incrementing count upward by one.
PV	Input	DINT	Programmed maximum value of the counter.
Q	Output	BOOL	Indicates whether the count up instruction has resulted in a number greater than or equal to the maximum value of the counter. TRUE - Counter result =>PV (Overflow condition). FALSE - Counter result < PV
CV	Output	DINT	Current counter result.

### CTU Function Block Diagram example

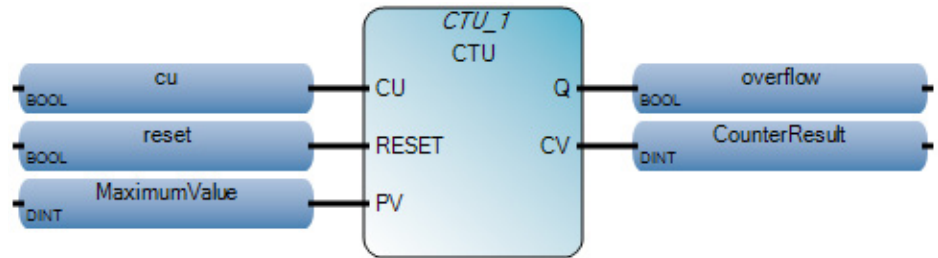

### CTU Ladder Diagram example

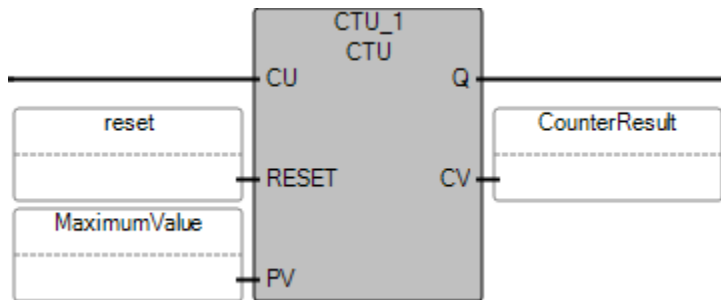

### CTU Structured Text example

```
CTU_1 {
  void CTU_1(BOOL CU, BOOL RESET, DINT PV)
  Type : CTU, Up counter
```

```
1 MaximumValue := 10;
2 CTU_1(cu, reset, MaximumValue);
```

(\* ST Equivalence: CTU1 is an instance of CTU block\*)

```
CTU1(trigger, NOT(auto_mode), 100);
overflow := CTU1.Q;
result := CTU1.CV;
```

## Results

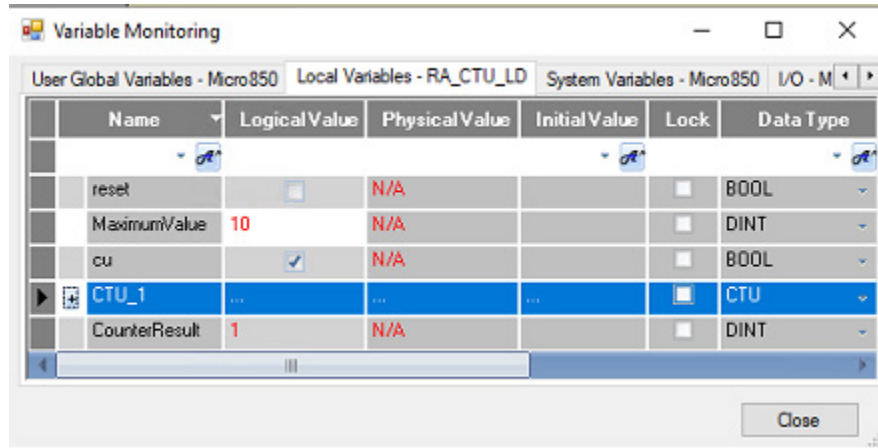

### CTUD (count up down)

Counts integers from 0 up to a given value, 1 by 1, or from a given value down to 0, 1 by 1.

Languages supported: Function Block Diagram, Ladder Diagram, Structured Text.

This instruction applies to the Micro810, Micro820, Micro830, Micro850, Micro870 controllers and Micro800 Simulator.

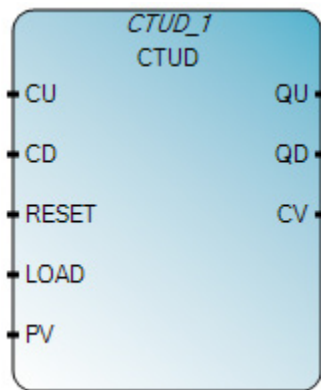

Use this table to help determine the parameter values for this instruction.

Parameter	Parameter Type	Data Type	Description
CU	Input	BOOL	TRUE - Rising Edge detected, count up.
CD	Input	BOOL	TRUE - Rising Edge detected, count down.
RESET	Input	BOOL	Reset dominant (highest priority when determining instruction behavior) command. (CV = 0 when RESET is TRUE).
LOAD	Input	BOOL	Load command. TRUE - set CV = PV.
PV	Input	DINT	Programmed maximum value.
QU	Output	BOOL	Overflow. TRUE - when CV >= PV.
QD	Output	BOOL	Underflow. TRUE - when CV <= 0.
CV	Output	DINT	Counter result.

### CTUD Function Block Diagram example

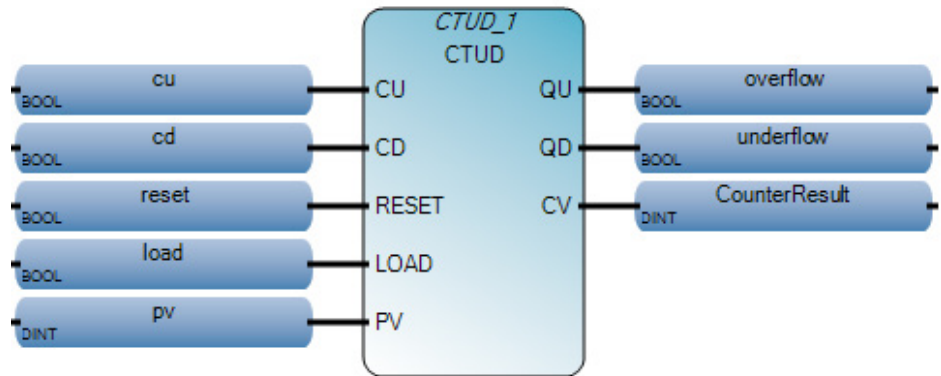

### CTUD Ladder Diagram example

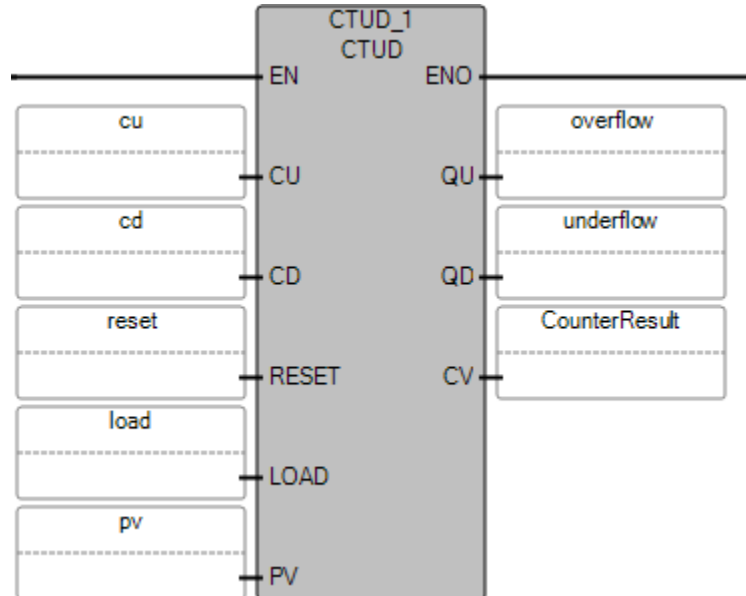

### CTUD Structured Text example

```

1 cu := TRUE;
2 cd := TRUE;
3 reset := FALSE;
4 load := FALSE;
5 pv := 10;
6 CTUD_1(cu, cd, reset, load, pv);

```

```

CTUD_1(
void CTUD_1(BOOL CU, BOOL CD, BOOL RESET, BOOL LOAD, DINT PV)
Type : CTUD, Up-down counter

```

(\* ST Equivalence: We suppose CTUD1 is an instance of block\*)



```
CTUD1(trigger1, trigger2, reset_cmd, load_cmd,100);  
full := CTUD1.QU;  
empty := CTUD1.QD;  
nb_elt := CTUD1.CV;
```



## Data conversion instructions

Use Data conversion instructions to convert the data type of a variable to a different data type.

Instruction	Description
<a href="#">ANY_TO_BOOL</a> on <a href="#">page 259</a>	Converts a non-Boolean value to a Boolean.
<a href="#">ANY_TO_BYTE</a> on <a href="#">page 260</a>	Converts a value to a Byte.
<a href="#">ANY_TO_DATE</a> on <a href="#">page 261</a>	Converts a String, Integer, Real, or Time data type to Date data type.
<a href="#">ANY_TO_DINT</a> on <a href="#">page 263</a>	Converts a value to a Double Integer.
<a href="#">ANY_TO_DWORD</a> on <a href="#">page 264</a>	Converts a value to a Double Word value.
<a href="#">ANY_TO_INT</a> on <a href="#">page 265</a>	Converts a value to an Integer.
<a href="#">ANY_TO_LINT</a> on <a href="#">page 266</a>	Converts a value to a Long Integer.
<a href="#">ANY_TO_LREAL</a> on <a href="#">page 267</a>	Converts a value to a Long Real.
<a href="#">ANY_TO_LWORD</a> on <a href="#">page 268</a>	Converts a value to a Long Word.
<a href="#">ANY_TO_REAL</a> on <a href="#">page 269</a>	Converts a value to a Real.
<a href="#">ANY_TO_SINT</a> on <a href="#">page 270</a>	Converts a value to a Short Integer.
<a href="#">ANY_TO_STRING</a> on <a href="#">page 270</a>	Converts a value to a String.
<a href="#">ANY_TO_TIME</a> on <a href="#">page 272</a>	Converts a value to the Time data type.
<a href="#">ANY_TO_UDINT</a> on <a href="#">page 273</a>	Converts a value to an Unsigned Double Integer.
<a href="#">ANY_TO_UINT</a> on <a href="#">page 274</a>	Converts a value to an Unsigned Integer.
<a href="#">ANY_TO_ULINT</a> on <a href="#">page 275</a>	Converts a value to an Unsigned Long Integer.
<a href="#">ANY_TO_USINT</a> on <a href="#">page 276</a>	Converts a value to an Unsigned Short Integer.
<a href="#">ANY_TO_WORD</a> on <a href="#">page 277</a>	Converts a value to a Word.

### ANY\_TO\_BOOL

Converts a non-Boolean value to a Boolean value.

Languages supported: Function Block Diagram, Ladder Diagram, Structured Text.

This instruction applies to the Micro810, Micro820, Micro830, Micro850, Micro870 controllers and Micro800 Simulator.

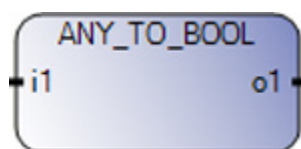

Use this table to help determine the parameter values for this instruction.

Parameter	Parameter Type	Data Type	Description

EN	Input	BOOL	Instruction enable. TRUE - execute the conversion to Boolean computation. FALSE - there is no computation. Applies to Ladder Diagram programs.
i1	Input	SINT USINT BYTE INT UINT WORD DINT UDINT DWORD LINT ULINT LWORD REAL LREAL TIME DATE STRING	Any non-Boolean value.
o1	Output	BOOL	Boolean value.

### ANY\_TO\_BOOL Structured Text example

(\* ST Equivalence: \*)

```
ares := ANY_TO_BOOL(10);           (* ares is TRUE *)
tres := ANY_TO_BOOL(t#0s);        (* tres is FALSE *)
mres := ANY_TO_BOOL('FALSE');     (* mres is FALSE *)
```

### ANY\_TO\_BYTE

Converts a value to an 8-bit Byte value.

Languages supported: Function Block Diagram, Ladder Diagram, Structured Text.

This instruction applies to the Micro810, Micro820, Micro830, Micro850, Micro870 controllers and Micro800 Simulator.

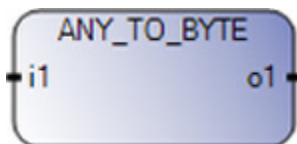

Use this table to help determine the parameter values for this instruction.

Parameter	Parameter Type	Data Type	Description
EN	Input	BOOL	Instruction enable. TRUE - execute the conversion to Byte computation. FALSE - there is no computation. Applies to Ladder Diagram programs.

i1	Input	BOOL SINT USINT INT UINT WORD DINT UDINT DWORD LINT ULINT LWORD REAL LREAL TIME DATE STRING	Any non-Byte value.
o1	Output	BYTE	An 8-bit Byte value.
ENO	Output	BOOL	Enable out. Applies only to Ladder Diagram programs.

### ANY\_TO\_BYTE Structured Text example

(\* ST Equivalence: \*)

```

bres := ANY_TO_BYTE (true);           (* bres is 1 *)
tres := ANY_TO_BYTE (t#0s46ms);      (* tres is 46 *)
mres := ANY_TO_BYTE ('0198');        (* mres is 198 *)

```

### ANY\_TO\_DATE

Converts a String, Integer, Real, or Time data type to Date data type.

Boolean, Byte, and Word date types are supported but are not recommended.

Languages supported: Function Block Diagram, Ladder Diagram, Structured Text.

This instruction applies to the Micro810, Micro820, Micro830, Micro850, Micro870 controllers and Micro800 Simulator.

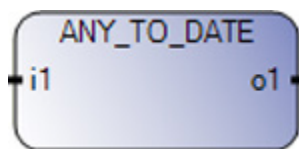

Use this table to help determine the parameter values for this instruction.

Parameter	Parameter Type	Data Type	Description
EN	Input	BOOL	Instruction enable. TRUE - execute the conversion to the Date computation. FALSE - there is no computation. Applies only to Ladder Diagram programs.

i1	Input	BOOL SINT USINT BYTE INT UINT WORD DINT UDINT DWORD LINT ULINT LWORD REAL LREAL TIME STRING	<ul style="list-style-type: none"> <li>• Strings are directly converted to DATE data type and must be in the format of YYYY-MM-DD, DATE#YYYY-MM-DD, or D#YYYY-MM-DD.</li> <li>• Integers and Real, which must be positive, are in units of seconds and added to the date 1970-01-01.</li> <li>• Time is added to the date 1970-01-01.</li> </ul>
o1	Output	DATE	Converted date value. Errors during conversion (such as a negative date) results in an INVALID result.
ENO	Output	BOOL	Enable output. Applies only to Ladder Diagram programs.

### ANY\_TO\_DATE Function Block Diagram example

ANY\_TO\_DATE

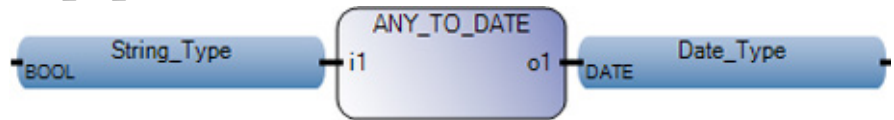

### ANY\_TO\_DATE Ladder Diagram example

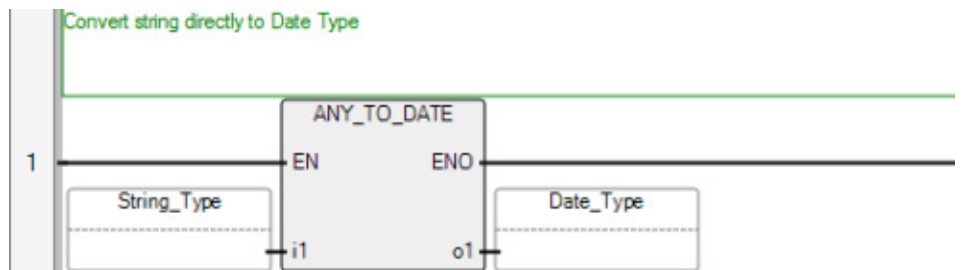

## ANY\_TO\_DATE Structured Text example

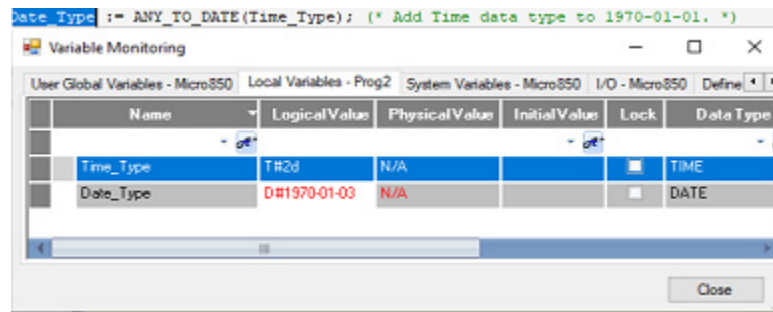

## ANY\_TO\_DINT

Converts a value to 32-bit Double Integer value.

Languages supported: Function Block Diagram, Ladder Diagram, Structured Text.

This instruction applies to the Micro810, Micro820, Micro830, Micro850, Micro870 controllers and Micro800 Simulator.

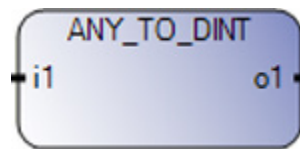

Use this table to help determine the parameter values for this instruction.

Parameter	Parameter Type	Data Type	Description
EN	Input	BOOL	Instruction enable. TRUE - execute the conversion to the 32-bit Double Integer computation. FALSE - there is no computation. Applies only to Ladder Diagram programs.
i1	Input	BOOL SINT USINT BYTE INT UINT WORD UDINT DWORD LINT ULINT LWORD REAL LREAL TIME DATE STRING	Any value other than a Double Integer.
o1	Output	DINT	A 32-bit Double Integer value.
ENO	Output	BOOL	Enable output. Applies only to Ladder Diagram programs.

### ANY\_TO\_DINT Structured Text example

(\* ST Equivalence: \*)

```

bres := ANY_TO_DINT (true);           (* bres is 1 *)
tres := ANY_TO_DINT (t#1s46ms);      (* tres is 1046 *)
mres := ANY_TO_DINT ('0198');        (* mres is 198 *)
    
```

### ANY\_TO\_DWORD

Converts a value to a 32-bit double Word value.

Languages supported: Function Block Diagram, Ladder Diagram, Structured Text.

This instruction applies to the Micro810, Micro820, Micro830, Micro850, Micro870 controllers and Micro800 Simulator.

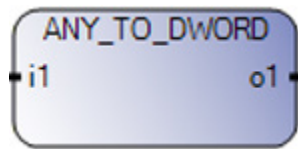

Use this table to help determine the parameter values for this instruction.

Parameter	Parameter Type	Data Type	Description
EN	Input	BOOL	Instruction enable. TRUE - execute the conversion to the 32-bit double Word computation. FALSE - there is no computation. Applies only to Ladder Diagram programs.
i1	Input	BOOL SINT USINT BYTE INT UINT WORD DINT UDINT LINT ULINT LWORD REAL LREAL TIME DATE STRING	Any value other than a double word.
o1	Output	DWORD	A 32-bit double Word value.
ENO	Output	BOOL	Enable output. Applies only to Ladder Diagram programs.



## ANY\_TO\_DWORD Structured Text example

(\* ST Equivalence: \*)

```

bres := ANY_TO_DWORD (true);           (* bres is 1 *)
tres := ANY_TO_DWORD (t#1s46ms);     (* tres is 1046 *)
mres := ANY_TO_DWORD ('0198');       (* mres is 198 *)

```

## ANY\_TO\_INT

Converts a value to a 16-bit Integer value.

Languages supported: Function Block Diagram, Ladder Diagram, Structured Text.

This instruction applies to the Micro810, Micro820, Micro830, Micro850, Micro870 controllers and Micro800 Simulator.

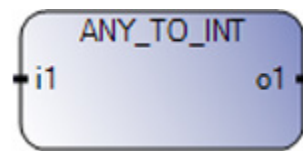

Use this table to help determine the parameter values for this instruction.

Parameter	Parameter Type	Data Type	Description
EN	Input	BOOL	Instruction enable. TRUE - execute the conversion to the 16-bit Integer computation. FALSE - there is no computation. Applies only to Ladder Diagram programs.
i1	Input	BOOL SINT USINT BYTE UINT WORD DINT UDINT DWORD LINT ULINT LWORD REAL LREAL TIME DATE STRING	Any non-16-bit Integer value.
o1	Output	INT	A 16-bit Integer value.
ENO	Output	BOOL	Enable output. Applies only to Ladder Diagram programs.

### ANY\_TO\_INT Structured Text example

(\* ST Equivalence: \*)

```

bres := ANY_TO_INT (true);           (* bres is 1 *)
tres := ANY_TO_INT (t#0s46ms);     (* tres is 46 *)
mres := ANY_TO_INT ('0198');       (* mres is 198 *)
    
```

## ANY\_TO\_LINT

Converts a value to a 64-bit Long Integer value.

Languages supported: Function Block Diagram, Ladder Diagram, Structured Text.

This instruction applies to the Micro810, Micro820, Micro830, Micro850, Micro870 controllers and Micro800 Simulator.

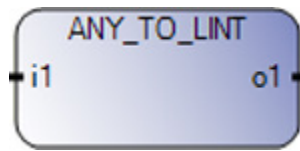

Use this table to help determine the parameter values for this instruction.

Parameter	Parameter Type	Data Type	Description
EN	Input	BOOL	Instruction enable. TRUE - execute the conversion to the 64-bit Long Integer computation. FALSE - there is no computation. Applies only to Ladder Diagram programs.
i1	Input	BOOL SINT USINT BYTE INT UINT WORD DINT UDINT DWORD LINT ULINT LWORD REAL LREAL TIME DATE STRING	Any value other than a Long Integer.
o1	Output	LINT	A 64-bit Long Integer value.
ENO	Output	BOOL	Enable output. Applies only to Ladder Diagram programs.

## ANY\_TO\_LINT Structured Text example

(\* ST Equivalence: \*)

```

bres := ANY_TO_LINT (true);           (* bres is 1 *)
tres := ANY_TO_LINT (t#0s46ms);      (* tres is 46 *)
mres := ANY_TO_LINT ('0198');        (* mres is 198 *)

```

## ANY\_TO\_LREAL

Converts any value to a Long Real value.

Languages supported: Function Block Diagram, Ladder Diagram, Structured Text.

This instruction applies to the Micro810, Micro820, Micro830, Micro850, Micro870 controllers and Micro800 Simulator.

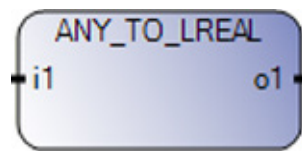

Use this table to help determine the parameter values for this instruction.

Parameter	Parameter Type	Data Type	Description
EN	Input	BOOL	Instruction enable. TRUE - execute the conversion to the long Real computation. FALSE - there is no computation. Applies only to Ladder Diagram programs.
i1	Input	BOOL SINT USINT BYTE INT UINT WORD DINT UDINT DWORD LINT ULINT LWORD REAL TIME DATE STRING	Any value other than a long Real.
o1	Output	LREAL	A long real value.
ENO	Output	BOOL	Enable output. Applies only to Ladder Diagram programs.

## ANY\_TO\_LREAL Structured Text example

(\* ST Equivalence: \*)

```

bres := ANY_TO_LREAL (true);           (* bres is 1.0 *)
tres := ANY_TO_LREAL (t#1s46ms);      (* tres is 1046.0 *)
ares := ANY_TO_LREAL (198);           (* ares is 198.0 *)
    
```

## ANY\_TO\_LWORD

Converts a value to a 64-bit Long Word value.

Languages supported: Function Block Diagram, Ladder Diagram, Structured Text.

This instruction applies to the Micro810, Micro820, Micro830, Micro850, Micro870 controllers and Micro800 Simulator.

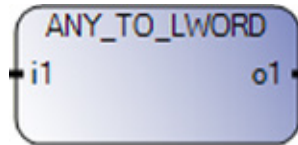

Use this table to help determine the parameter values for this instruction.

Parameter	Parameter Type	Data Type	Description
EN	Input	BOOL	Instruction enable. TRUE - execute the conversion to the 64-bit Long Word computation. FALSE - there is no computation. Applies only to Ladder Diagram programs.
i1	Input	BOOL SINT USINT BYTE INT UINT WORD DINT UDINT DWORD LINT ULINT REAL LREAL IME DATE STRING	Any value other than a Long Word.
o1	Output	LWORD	A 64-bit Long Word value.
ENO	Output	BOOL	Enable output. Applies only to Ladder Diagram programs.

### ANY\_TO\_LWORD Structured Text example

(\* ST Equivalence: \*)

```

bres := ANY_TO_LWORD (true);           (* bres is 1 *)
tres := ANY_TO_LWORD (t#0s46ms);      (* tres is 46 *)
    
```

```
mres := ANY_TO_LWORD ('0198');
```

```
(* mres is 198 *)
```

## ANY\_TO\_REAL

Converts a value to a Real value.

Languages supported: Function Block Diagram, Ladder Diagram, Structured Text.

This instruction applies to the Micro810, Micro820, Micro830, Micro850, Micro870 controllers and Micro800 Simulator.

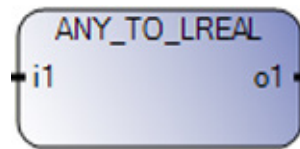

Use this table to help determine the parameter values for this instruction.

Parameter	Parameter Type	Data Type	Description
EN	Input	BOOL	Instruction enable. TRUE - execute the conversion to the Real computation. FALSE - there is no computation. Applies only to Ladder Diagram programs.
i1	Input	BOOL SINT USINT BYTE INT UINT WORD DINT UDINT DWORD LINT ULINT LWORD LREAL TIME DATE STRING	Any value other than Real.
o1	Output	REAL	A real value.
ENO	Output	BOOL	Enable output. Applies only to Ladder Diagram programs.

### ANY\_TO\_REAL Structured Text example

(\* ST Equivalence: \*)

```
bres := ANY_TO_REAL (true);
```

```
(* bres is 1.0 *)
```

```
tres := ANY_TO_REAL (t#1s46ms);
```

```
(* tres is 1046.0 *)
```

```
ares := ANY_TO_REAL (198);
```

```
(* ares is 198.0 *)
```

## ANY\_TO\_SINT

Converts a value to a Short Integer value.

Languages supported: Function Block Diagram, Ladder Diagram, Structured Text.

This instruction applies to the Micro810, Micro820, Micro830, Micro850, Micro870 controllers and Micro800 Simulator.

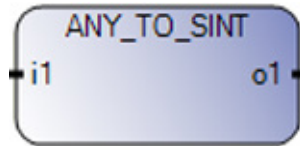

Use this table to help determine the parameter values for this instruction.

Parameter	Parameter Type	Data Type	Description
EN	Input	BOOL	Instruction enable. TRUE - execute the conversion to the 8-bit Short Integer computation. FALSE - there is no computation. Applies only to Ladder Diagram programs.
i1	Input	BOOL USINT BYTE INT UINT WORD DINT UDINT DWORD LINT ULINT LWORD REAL LREAL TIME DATE STRING	Any non-Short Integer value.
o1	Output	SINT	A Short Integer value.
ENO	Output	BOOL	Enable output. Applies only to Ladder Diagram programs.

### ANY\_TO\_SINT Structured Text example

(\* ST Equivalence: \*)

```

bres := ANY_TO_SINT (true);           (* bres is 1 *)
tres := ANY_TO_SINT (t#0s46ms);      (* tres is 46 *)
mres := ANY_TO_SINT ('0198');        (* mres is 198 *)
    
```

## ANY\_TO\_STRING

Converts a value to a String value.

Operation details:

- When converting a REAL data type to a String the ANY\_TO\_STRING instruction uses the IEEE 754 format.
  - ANY\_TO\_STRING converts 125.0 to 1.25000E+02
- When the target string length is 5 chars:
  - ANY\_TO\_STRING converts 125.0 to 1.25000E+02 and outputs 1.250 to the target string.
  - Consider creating a user-defined function block to convert from Exponential notation to number.

Languages supported: Function Block Diagram, Ladder Diagram, Structured Text.

This instruction applies to the Micro810, Micro820, Micro830, Micro850, Micro870 controllers and Micro800 Simulator.

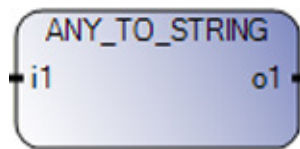

Use this table to help determine the parameter values for this instruction.

Parameter	Parameter Type	Data Type	Description
EN	Input	BOOL	Instruction enable. TRUE - execute the conversion to String computation. FALSE - there is no computation. Applies only to Ladder Diagram programs.
i1	Input	BOOL SINT USINT BYTE INT UINT WORD DINT UDINT DWORD LINT ULINT LWORD REAL LREAL TIME DATE	Any value other than String.

o1	Output	STRING	<p>If IN is a Boolean, 'FALSE' or 'TRUE'.</p> <p>If IN is an Integer or a real, a decimal representation.</p> <p>If IN is a TIME, can be:</p> <p>TIME time1</p> <p>STRING s1</p> <p>time1 :=13 ms;</p> <p>s1:=ANY_TO_STRING(time1);</p> <p>(* s1 = '0s13' *).</p>
ENO	Output	BOOL	<p>Enable output.</p> <p>Applies only to Ladder Diagram programs.</p>

### ANY\_TO\_STRING Structured Text example

(\* ST Equivalence: \*)

```

bres := ANY_TO_STRING(TRUE);           (* bres is 'TRUE' *)
ares := ANY_TO_STRING(125);           (* ares is '125' *)
    
```

### ANY\_TO\_TIME

Converts a non-Time or non-Date value to a Time value.

Languages supported: Function Block Diagram, Ladder Diagram, Structured Text.

This instruction applies to the Micro810, Micro820, Micro830, Micro850, Micro870 controllers and Micro800 Simulator.

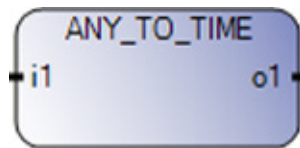

Use this table to help determine the parameter values for this instruction.

Parameter	Parameter Type	Data Type	Description
EN	Input	BOOL	<p>Instruction enable.</p> <p>TRUE - execute the conversion to the Time computation.</p> <p>FALSE - there is no computation.</p> <p>Applies only to Ladder Diagram programs.</p>



i1	Input	BOOL SINT USINT BYTE INT UINT WORD DINT UDINT DWORD LINT ULINT LWORD REAL LREAL STRING	Any positive value other than a Time or Date data type. IN (or integer part of IN if it is real) is the number of milliseconds. STRING (number of milliseconds, for example, a value of 300032 represents 5 minutes and 32 milliseconds).
o1	Output	TIME	Time value represented by IN. A value of 1193h2m47s295ms indicates an invalid time.
ENO	Output	BOOL	Enable output. Applies only to Ladder Diagram programs.

### ANY\_TO\_TIME Structured Text example

(\* ST Equivalence: \*)

```
ares := ANY_TO_TIME (1256);           (* ares := t#1s256ms *)
rres := ANY_TO_TIME (1256.3);        (* rres := t#1s256ms *)
```

### ANY\_TO\_UDINT

Converts a value to a 32-bit Unsigned Double Integer value.

Languages supported: Function Block Diagram, Ladder Diagram, Structured Text.

This instruction applies to the Micro810, Micro820, Micro830, Micro850, Micro870 controllers and Micro800 Simulator.

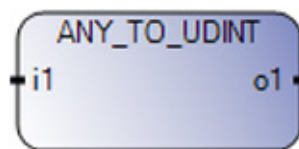

Use this table to help determine the parameter values for this instruction.

Parameter	Parameter Type	Data Type	Description
EN	Input	BOOL	Instruction enable. TRUE - execute the conversion to the 32-bit Double Integer computation. FALSE - there is no computation. Applies only to Ladder Diagram programs.

i1	Input	BOOL SINT USINT BYTE INT UINT WORD DINT DWORD LINT ULINT LWORD REAL LREAL TIME DATE STRING	Any value other than an Unsigned Double Integer.
o1	Output	UDINT	A 32-bit Unsigned Double Integer value.
ENO	Output	BOOL	Enable output. Applies only to Ladder Diagram programs.

### ANY\_TO\_UDINT Structured Text example

(\* ST Equivalence: \*)

```

bres := ANY_TO_UDINT (true);           (* bres is 1 *)
tres := ANY_TO_UDINT (t#1s46ms);      (* tres is 1046 *)
mres := ANY_TO_UDINT ('0198');        (* mres is 198 *)
  
```

## ANY\_TO\_UINT

Converts a value to an Unsigned Integer value.

Languages supported: Function Block Diagram, Ladder Diagram, Structured Text.

This instruction applies to the Micro810, Micro820, Micro830, Micro850, Micro870 controllers and Micro800 Simulator.

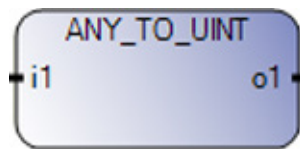

Use this table to help determine the parameter values for this instruction.

Parameter	Parameter Type	Data Type	Description
EN	Input	BOOL	Instruction enable. TRUE - execute the conversion to the 16-bit Unsigned Integer computation. FALSE - there is no computation. Applies only to Ladder Diagram programs.

i1	Input	BOOL SINT USINT BYTE INT WORD DINT UDINT DWORD LINT ULINT LWORD REAL LREAL TIME DATE STRING	Any non-Unsigned Integer value.
o1	Output	UINT	An Unsigned Integer value.
ENO	Output	BOOL	Enable output. Applies only to Ladder Diagram programs.

### ANY\_TO\_UINT Structured Text example

(\* ST Equivalence: \*)

```

bres := ANY_TO_UINT (true);           (* bres is 1 *)
tres := ANY_TO_UINT (t#0s46ms);      (* tres is 46 *)
mres := ANY_TO_UINT ('0198');        (* mres is 198 *)
  
```

## ANY\_TO\_ULINT

Converts a value to a 64-bit Unsigned Long Integer value.

Languages supported: Function Block Diagram, Ladder Diagram, Structured Text.

This instruction applies to the Micro810, Micro820, Micro830, Micro850, Micro870 controllers and Micro800 Simulator.

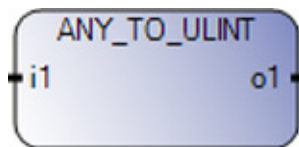

Use this table to help determine the parameter values for this instruction.

Parameter	Parameter Type	Data Type	Description
EN	Input	BOOL	Instruction enable. TRUE - execute the conversion to the 64-bit Unsigned Long Integer computation. FALSE - there is no computation. Applies only to Ladder Diagram programs.

i1	Input	BOOL SINT USINT BYTE INT UINT WORD DINT UDINT DWORD LINT LWORD REAL LREAL TIME DATE STRING	Any value other than an Unsigned Long Integer.
o1	Output	ULINT	A 64-bit Unsigned Long Integer value.
ENO	Output	BOOL	Enable output. Applies only to Ladder Diagram programs.

### ANY\_TO\_ULINT Structured Text example

(\* ST Equivalence: \*)

```

bres := ANY_TO_ULINT (true);           (* bres is 1 *)
tres := ANY_TO_ULINT (t#0s46ms);      (* tres is 46 *)
mres := ANY_TO_ULINT ('0198');        (* mres is 198 *)
  
```

## ANY\_TO\_USINT

Converts a value to an Unsigned Short Integer value.

Languages supported: Function Block Diagram, Ladder Diagram, Structured Text.

This instruction applies to the Micro810, Micro820, Micro830, Micro850, Micro870 controllers and Micro800 Simulator.

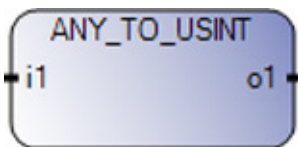

Use this table to help determine the parameter values for this instruction.

Parameter	Parameter Type	Data Type	Description
EN	Input	BOOL	Instruction enable. TRUE - execute the conversion to the 8-bit Unsigned Short Integer computation. FALSE - there is no computation. Applies only to Ladder Diagram programs.

i1	Input	BOOL SINT BYTE INT UINT WORD DINT UDINT DWORD LINT ULINT LWORD REAL LREAL TIME DATE STRING	Any non-Short Integer value.
o1	Output	USINT	An Unsigned Short Integer value.
ENO	Output	BOOL	Enable output. Applies only to Ladder Diagram programs.

### ANY\_TO\_USINT Structured Text example

(\* ST Equivalence: \*)

```

bres := ANY_TO_USINT (true);           (* bres is 1 *)
tres := ANY_TO_USINT (t#0s46ms);      (* tres is 46 *)
mres := ANY_TO_USINT ('0198');        (* mres is 198 *)
  
```

## ANY\_TO\_WORD

Converts a value to a 16-bit Word value.

Languages supported: Function Block Diagram, Ladder Diagram, Structured Text.

This instruction applies to the Micro810, Micro820, Micro830, Micro850, Micro870 controllers and Micro800 Simulator.

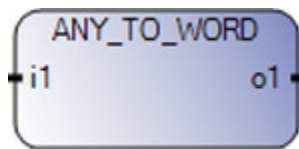

Use this table to help determine the parameter values for this instruction.

Parameter	Parameter Type	Data Type	Description
EN	Input	BOOL	Instruction enable. TRUE - execute the conversion to the 16-bit Word computation. FALSE - there is no computation. Applies only to Ladder Diagram programs.

i1	Input	BOOL SINT USINT BYTE INT DINT UDINT DWORD LINT ULINT LWORD REAL LREAL TIME DATE STRING	Any value other than a WORD value.
o1	Output	WORD	A Word value.
ENO	Output	BOOL	Enable output. Applies only to Ladder Diagram programs.

### ANY\_TO\_WORD Structured Text example

(\* ST Equivalence: \*)

```

bres := ANY_TO_WORD (true);           (* bres is 1 *)
tres := ANY_TO_WORD (t#0s46ms);      (* tres is 46 *)
mres := ANY_TO_WORD ('0198');        (* mres is 198 *)
  
```

## Data manipulation instructions

Use Data manipulation instructions to alter the output data to change the status without altering the program.

Instruction	Description
<a href="#">AVERAGE</a> on <a href="#">page 279</a>	Calculates a running average over a number of a defined samples.
<a href="#">COP</a> on <a href="#">page 280</a>	Copies the binary data in the source element to the destination element.
<a href="#">MAX</a> on <a href="#">page 287</a>	Calculates the maximum of two integer values.
<a href="#">MIN</a> on <a href="#">page 286</a>	Calculates the minimum of two integer values.

### AVERAGE

Calculates a running average over a number of a defined samples and stores the value at each cycle.

Operation details:

- The defined number of samples (N) cannot exceed 127.
- When setting or changing the value for N, set RUN to FALSE, then set it back to TRUE.
- If the RUN command is FALSE (reset mode), the output value is equal to the input value.
- When the maximum number of stored values is reached, the first stored value is erased by the last one.
- Using floating-point data types could result in inaccurate calculations due to the rounding limitations inherent in floating-point mathematics.

Languages supported: Function Block Diagram, Ladder Diagram, Structured Text.

This instruction applies to the Micro810, Micro820, Micro830, Micro850, Micro870 controllers and Micro800 Simulator.

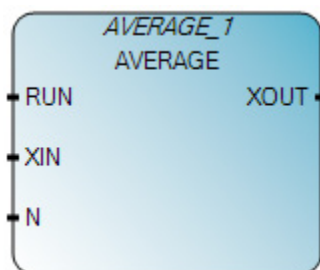

Use this table to help determine the parameter values for this instruction.

Parameter	Parameter Type	Data Type	Description
RUN	Input	BOOL	TRUE = run FALSE = reset
XIN	Input	REAL	Any real variable.
N	Input	DINT	Application defined number of samples.
XOUT	Output	REAL	Running average of XIN value.
ENO	Output	BOOL	Enable output. Applies only to Ladder Diagram programs.

### AVERAGE Function Block Diagram example

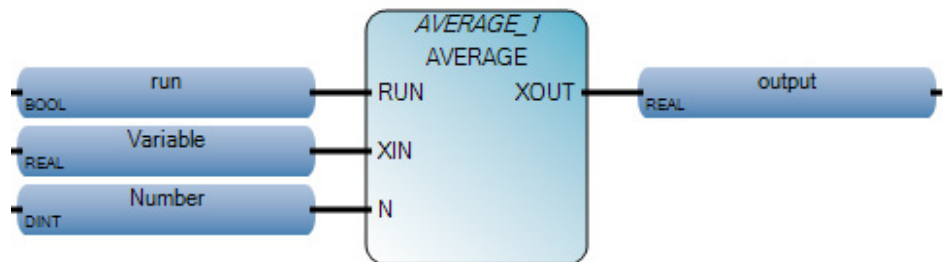

### AVERAGE Ladder Diagram example

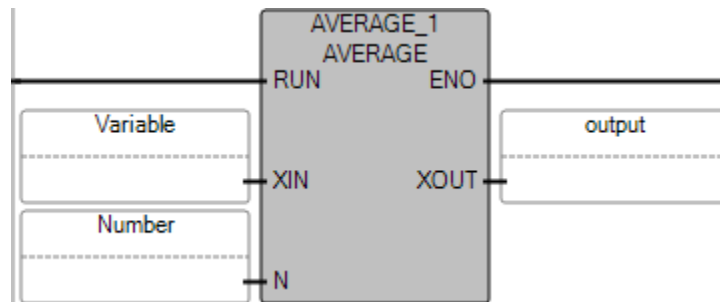

### AVERAGE Structured Text example

```
AVERAGE_1(
void AVERAGE_1(BOOL RUN, REAL XIN, DINT N)
Type : AVERAGE, Running average over N samples
```

```
1 | AVERAGE_1(run, Variable, Number);
2 | output := AVERAGE_1.XOUT;
```

(\* ST Equivalence: AVERAGE1 an instance of an AVERAGE block \*)

```
AVERAGE1((auto_mode & store_cmd), sensor_value, 100);
ave_value := AVERAGE1.XOUT;
```

## COP

Copies the binary data in the source element to the destination element. The source element remains unchanged.



Languages supported: Function Block Diagram, Ladder Diagram, Structured Text.

This instruction applies to the Micro820, Micro830, Micro850, Micro870 controllers and Micro800 Simulator.

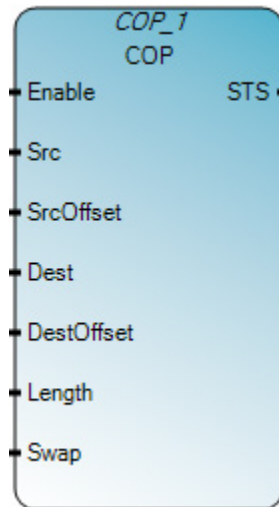

Use this table to help determine the parameter values for this instruction.

Parameter	Parameter Type	Data Type	Description																		
Enable	Input	BOOL	Instruction block enable. COP iis level triggered. TRUE - perform copy. FALSE - the function block is idle.																		
Src	Input	<table border="0"> <tr><td>BOOL</td><td>DWORD</td></tr> <tr><td>SINT</td><td>REAL</td></tr> <tr><td>USINT</td><td>TIME</td></tr> <tr><td>BYTE</td><td>DATE</td></tr> <tr><td>INT</td><td>STRING</td></tr> <tr><td>UINT</td><td>LWORD</td></tr> <tr><td>WORD</td><td>ULINT</td></tr> <tr><td>DINT</td><td>LINT</td></tr> <tr><td>UDINT</td><td>LREAL</td></tr> </table>	BOOL	DWORD	SINT	REAL	USINT	TIME	BYTE	DATE	INT	STRING	UINT	LWORD	WORD	ULINT	DINT	LINT	UDINT	LREAL	Initial element to copy. If the source is a STRING data type the destination must be a either a STRING data type or a USINT (UCHAR and BYTE) data type. If it is not, a data type mismatch is reported.
BOOL	DWORD																				
SINT	REAL																				
USINT	TIME																				
BYTE	DATE																				
INT	STRING																				
UINT	LWORD																				
WORD	ULINT																				
DINT	LINT																				
UDINT	LREAL																				
SrcOffset	Input	UINT	The source element offset is used with array data types to identify the position in the source array to copy the data from. Set the offset to 0 if: <ul style="list-style-type: none"> <li>• If it is not an array data type, or</li> <li>• To copy from the first element for an array data type.</li> </ul>																		
Dest	Input	<table border="0"> <tr><td>BOOL</td><td>DWORD</td></tr> <tr><td>SINT</td><td>REAL</td></tr> <tr><td>USINT</td><td>TIME</td></tr> <tr><td>BYTE</td><td>DATE</td></tr> <tr><td>INT</td><td>STRING</td></tr> <tr><td>UINT</td><td>LWORD</td></tr> <tr><td>WORD</td><td>ULINT</td></tr> <tr><td>DINT</td><td>LINT</td></tr> <tr><td>UDINT</td><td></td></tr> </table>	BOOL	DWORD	SINT	REAL	USINT	TIME	BYTE	DATE	INT	STRING	UINT	LWORD	WORD	ULINT	DINT	LINT	UDINT		Initial element to be overwritten by the source. If the destination is a STRING data type the source must be either a STRING data type or a USINT (UCHAR and BYTE) data type. If it is not, a data type mismatch is reported.
BOOL	DWORD																				
SINT	REAL																				
USINT	TIME																				
BYTE	DATE																				
INT	STRING																				
UINT	LWORD																				
WORD	ULINT																				
DINT	LINT																				
UDINT																					

DestOffset	Input	UINT	The destination element offset is used with array data types to identify the position in the destination array to copy the data to. Set the offset to 0 if: <ul style="list-style-type: none"> <li>• If it is not an array data type, or</li> <li>• To copy from the first element for an array data type.</li> </ul>
Length	Input	UINT	Number of destination elements to copy. When the destination is a STRING data type, it indicates the number of strings to be copied.
Swap	Input	BOOL	Used to exchange the data from the source and destination elements, so that the destination data replaces the source data and the source data replaces the destination data. TRUE - Swap bytes according to the data type. A swap operation does not occur if: <ul style="list-style-type: none"> <li>• The source data type or the destination data type is a STRING, or</li> <li>• If both the source and the destination are 1-byte length data.</li> </ul>
Sts	Output	UINT	Status of the copy operation. The definitions for the Sts parameter are defined in COP status codes.
ENO	Output	BOOL	Enables output. Applies only to Ladder Diagram programs.

### COP status codes (Sts)

The following table describes the COP status codes.

COP Status code	Status description
0x00	No action taken (not enabled).
0x01	COP function block success.
0x02	Destination has spare bytes when copying from String.
0x03	Source data are truncated.
0x04	Copy length is invalid.
0x05	Data type mismatch when there is String Data type as either source or destination.
0x06	Source data size is too small for copy.
0x07	Destination data size is too small for copy.
0x08	Source Data offset is invalid.
0x09	Destination Data offset is invalid.
0x0A	Data is invalid in either source or destination.

### COP Function Block Diagram example

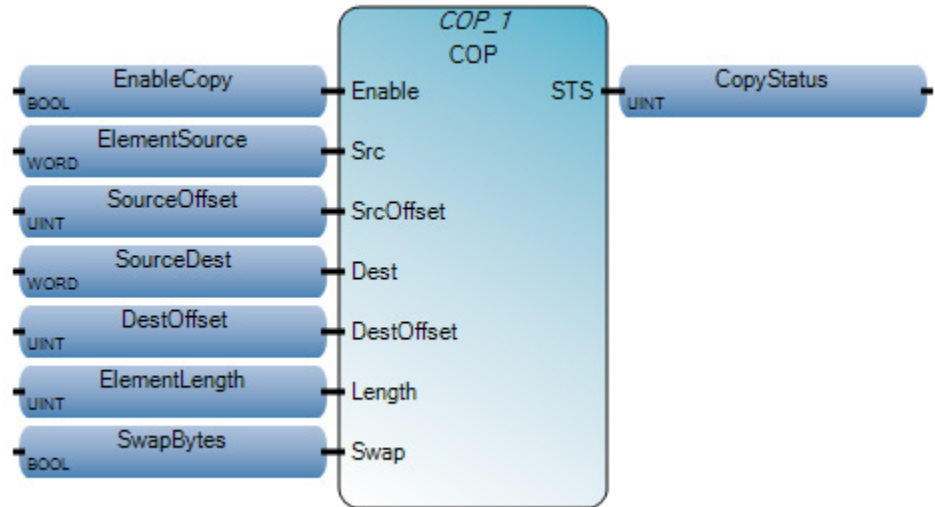

### COP Ladder Diagram example

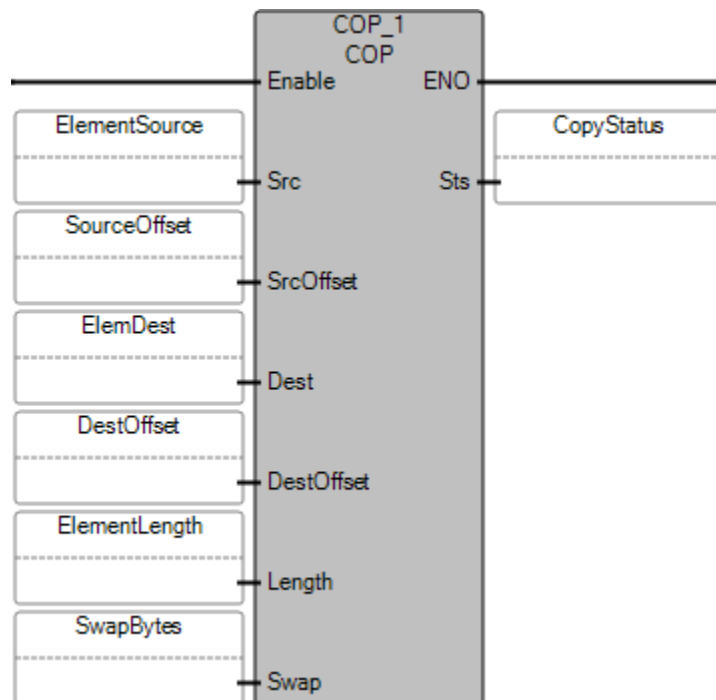

### COP Structured Text example

```

1 COP_1(EnableCopy, ElementSource, SourceOffset, SourceDest,
2   DestOffset, ElementLength, SwapBytes);
3 output :=COP_1.STS;

```

### Copy to a different data type

When a copy to or from a String data type is performed, the ODVA short String format is used for data in the USINT array.

When [COP](#) on [page 280](#) is used between any other pair of data types, the copy operation is valid, even if the data type in the source is not the same as the data type in the destination, and even when they are not in a valid format. The logic must be validated at the application level.

### From a USINT array to a String array

To copy a USINT array to a String array, the data in the USINT array must be in this format:

- Byte1: Length of first String
- Byte2: First Byte Character
- Byte3: Second Byte Character
- Byte n: Last Byte Character
- Byte (n+1): Length of second String
- Byte (n+2): First Byte Character for second String

### COP string array example

The following example shows a [COP](#) on [page 280](#) instruction copying a string array into Usint array. The COP instruction skips all the elements in the source array with Zero length.

For this example:

- Length is specified as 4 bytes.
- Number of Destination Elements to copy is 4 bytes.
- All the array elements with Zero length (blanks) are skipped.
- The COP instruction finds a non zero length element in the string array[1], which is copied into the designation Usint array[1] with 1. One is the length of the string in String array[1] and Usint array[2] is 65, which is the ASCII code of "A".
- The COP instruction finds a non zero length element in String array[10] which is "a", which is copied into destination Usint array[3] with 1. One is the length of string in String array[10] and Usint array[4] is 97 which is ASCII code of "a".

### Ladder Diagram

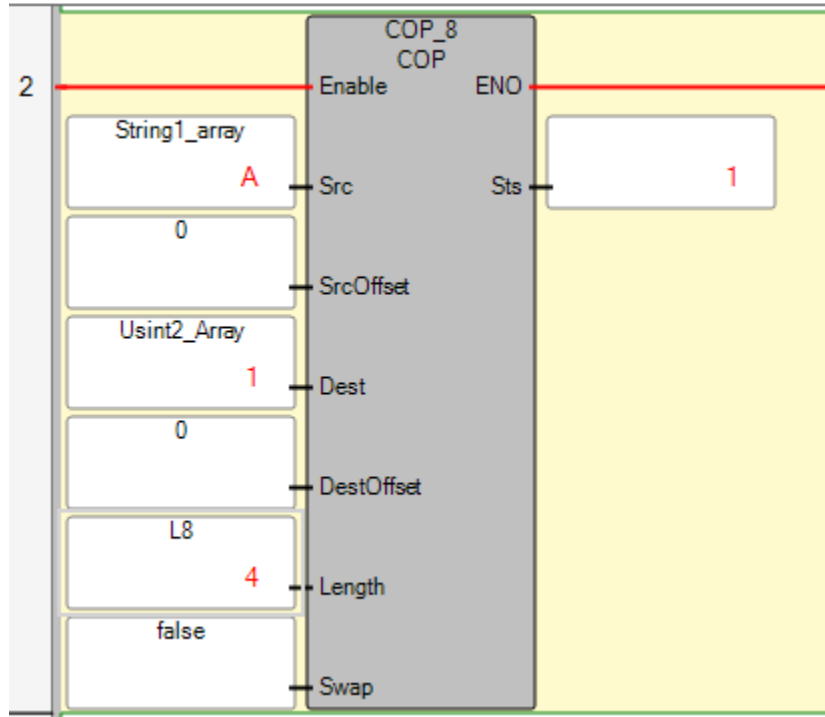

Array elements with Logical Values

Name	Alias	Logical Value
String_String_1.String1_array		...
String_String_1.String1_array[1]		A
String_String_1.String1_array[2]		
String_String_1.String1_array[3]		
String_String_1.String1_array[4]		
String_String_1.String1_array[5]		
String_String_1.String1_array[6]		
String_String_1.String1_array[7]		
String_String_1.String1_array[8]		
String_String_1.String1_array[9]		
String_String_1.String1_array[10]		a
String_String_1.COP_8		...
String_String_1.L8		4
String_String_1.Usint2_Array		...
String_String_1.Usint2_Array[1]		1
String_String_1.Usint2_Array[2]		65
String_String_1.Usint2_Array[3]		1
String_String_1.Usint2_Array[4]		97
String_String_1.Usint2_Array[5]		0
String_String_1.Usint2_Array[6]		0
String_String_1.Usint2_Array[7]		0
String_String_1.Usint2_Array[8]		0
String_String_1.Usint2_Array[9]		0
String_String_1.Usint2_Array[10]		0
String_String_1.Usint2_Array[11]		0
String_String_1.Usint2_Array[12]		0
String_String_1.Usint2_Array[13]		0



## MIN (minimum)

Calculates the minimum of two integer values.

Languages supported: Function Block Diagram, Ladder Diagram, Structured Text.

This instruction applies to the Micro810, Micro820, Micro830, Micro850, Micro870 controllers and Micro800 Simulator.



Use this table to help determine the parameter values for this instruction.

Parameter	Parameter Type	Data Type	Description
EN	Input	BOOL	Instruction enable. TRUE - execute the minimum integer value computation FALSE - there is no computation. Applies to Ladder Diagram programs.
IN1	Input	DINT	Any signed integer value.
IN2	Input	DINT	Cannot be Real.
MIN	Output	DINT	Minimum of both input values.
ENO	Output	BOOL	Enable output. Applies to Ladder Diagram programs.

### MIN Function Block Diagram example

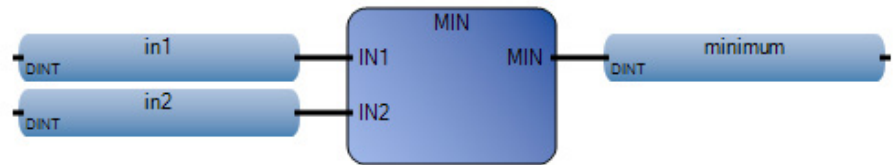

### MIN Ladder Diagram example

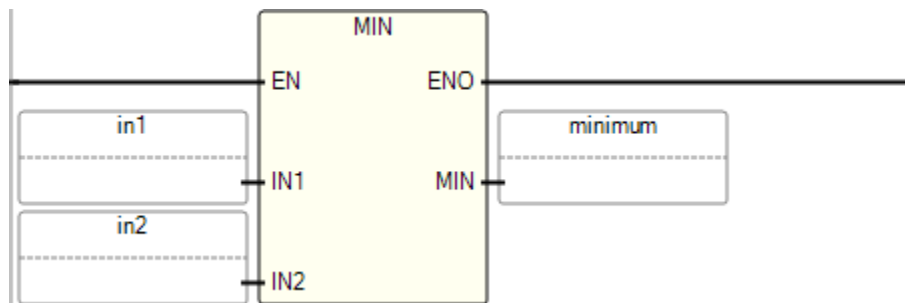

### MIN Structured Text example

```
MIN (
```

DINT MIN(DINT IN1, DINT IN2)  
Minimum

```
1 in1 := 3;
2 in2 := 10;
3 minimum := MIN(in1, in2);
```

(\* ST Equivalence: \*)

new\_value := MAX (MIN (max\_value, value), min\_value);

(\* bounds the value to the [min\_value..max\_value] set \*)

### Results

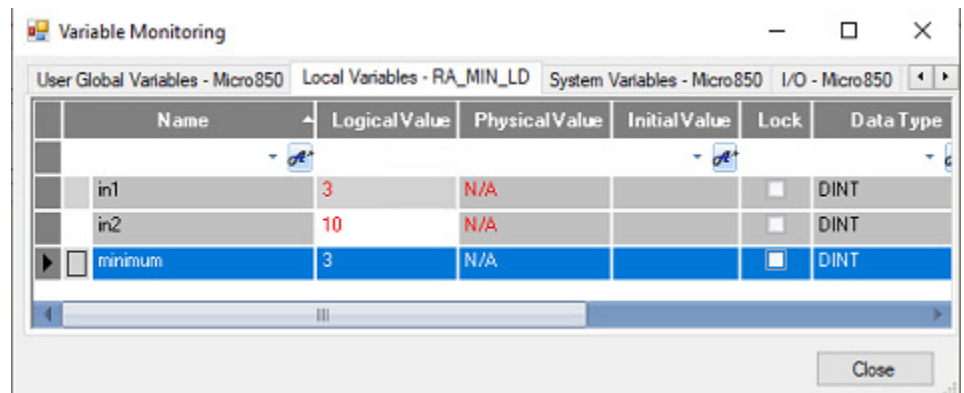

### MAX (maximum)

Calculates the maximum of two integer values.

Languages supported: Function Block Diagram, Ladder Diagram, Structured Text.

This instruction applies to the Micro810, Micro820, Micro830, Micro850, Micro870 controllers and Micro800 Simulator.



Use this table to help determine the parameter values for this instruction.

Parameter	Parameter Type	Data Type	Description
EN	Input	BOOL	Instruction enable. TRUE - execute maximum integer value computation. FALSE - there is no computation. Applies to Ladder Diagram programs.

IN1	Input	DINT	Any signed integer value.
IN2	Input	DINT	Cannot be Real.
MAX	Output	DINT	Maximum of both input values.
ENO	Output	BOOL	Enable output. Applies to Ladder Diagram programs.

### MAX Function Block Diagram example

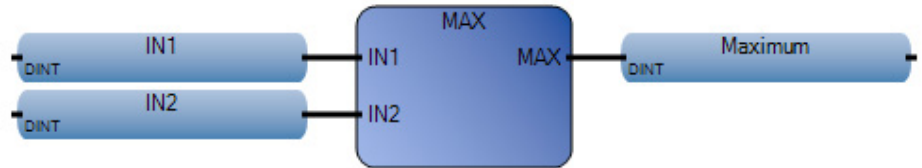

### MAX Ladder Diagram example

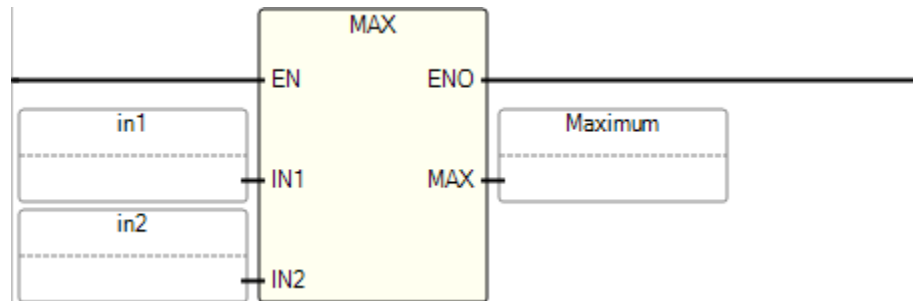

### MAX Structured Text example

```

MAX(
  DINT MAX(DINT IN1, DINT IN2)
  Maximum

1 IN1 := 3;
2 IN2 := 10;
3 Maximum := MAX(IN1, IN2);

```

(\* ST Equivalence: \*)

new\_value := MAX (MIN (max\_value, value), min\_value);

(\* bounds the value to the [min\_value..max\_value] set \*)



## Results

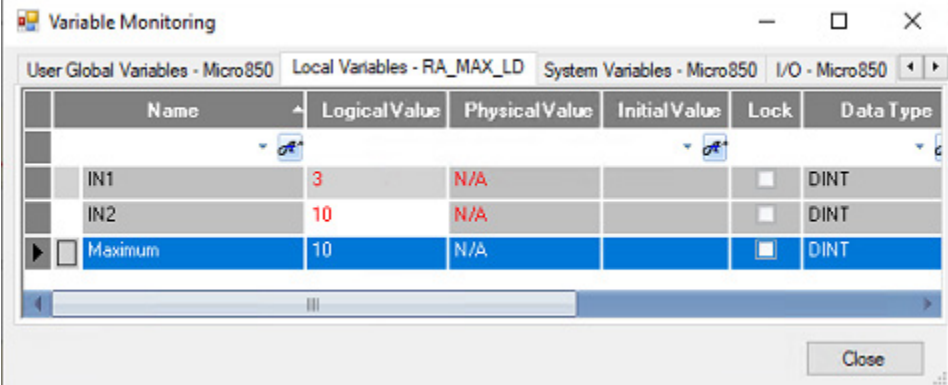

The Variable Monitoring window displays a table of variables. The table has columns for Name, Logical Value, Physical Value, Initial Value, Lock, and Data Type. The variables shown are IN1, IN2, and Maximum. IN1 has a Logical Value of 3 and a Physical Value of N/A. IN2 has a Logical Value of 10 and a Physical Value of N/A. Maximum has a Logical Value of 10 and a Physical Value of N/A. All variables have a Data Type of DINT. The Maximum variable is highlighted in blue.

Name	Logical Value	Physical Value	Initial Value	Lock	Data Type
IN1	3	N/A		<input type="checkbox"/>	DINT
IN2	10	N/A		<input type="checkbox"/>	DINT
Maximum	10	N/A		<input checked="" type="checkbox"/>	DINT



## High-Speed Counter (HSC) instructions

Use High-speed counter instructions to monitor and control the high-speed counter.

Instruction	Description
<a href="#">HSC</a> on <a href="#">page 292</a>	HSC applies high presets, low presets and output source values to the high-speed counter.
<a href="#">HSC_SET_STS</a> on <a href="#">page 307</a>	HSC_SET_STS manually sets or resets the HSC counting status.

### What is a High-Speed Counter?

A high-speed counter detects and counts narrow (fast) pulses and then issues specialized instructions to initiate control operations when the detected counts reach their preset values. Control operations include the automatic and immediate execution of the high-speed counter interrupt routine and the immediate update of outputs based on the configured source and mask pattern.

### High-speed counter capabilities

Because HSC instructions have high-performance requirements, their operation is performed by custom circuitry that runs in parallel with the main system processor. Enhanced capabilities of High-Speed Counters (HSC) include:

- 100 kHz operation high-speed direct control of outputs
- 32-bit signed integer data (count range of  $\pm 2,147,483,647$ )
- Programmable high and low presets
- Overflow and underflow setpoint
- Automatic interrupt processing based on accumulated count
- Run-time editable parameters (from the user control program) HSC instruction operation

### Micro800 controller support for HSC

All Micro830, Micro850 and Micro870 controllers, except for 2080-LCxx-AWB, support up to six HSC inputs. HSC functionality is implemented in Micro800 controllers using high-speed counter hardware (embedded inputs in the controller), and the HSC instruction in the application. The [HSC instruction](#) on [page 291](#) configures the high-speed counter hardware and updates the image accumulator.

**IMPORTANT** The HSC function can only be used with the controller's embedded I/O. It cannot be used with expansion I/O modules.

## HSC (high-speed counter)

HSC applies high presets, low presets and output source values to the high-speed counter.

Operation details:

- Programmable Limit Switch (PLS) is enabled by setting the HSCAppData.PLSEnable parameter to True.
- The PLSPosition parameter is reset after a full cycle completes and the HSCSTS.HP value is reached.

This instructions applies to the Micro830, Micro850, and Micro870 controllers.

Languages supported: Function Block Diagram, Ladder Diagram, Structured Text.

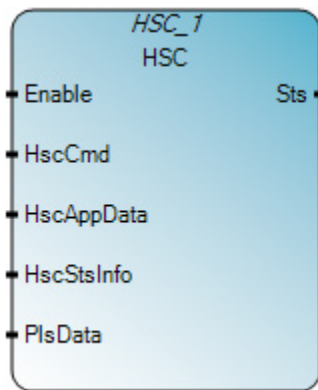

Use this table to help determine the parameter values for this instruction.

Parameter	Parameter Type	Data Type	Description
EN	Input	BOOL	Instruction block rung state. TRUE - the timer starts incrementing. FALSE - the function block is idle. The recommendation is not to use the EN parameter with the HSC function block because when EN is set to FALSE the timer continues to increment. Applies only to Ladder Diagram programs.
Enable	Input	BOOL	Enable instruction block. TRUE - execute the HSC operation specified in the HSC command parameter. FALSE - no HSC commands are issued.
HscCmd	Input	USINT	Issues commands to the HSC.
HSCAppData	Input	<a href="#">HSCAPP</a> on <a href="#">page 294</a>	HSC application configuration, which is usually only needed once.
HSCStsInfo	Input	<a href="#">HSCSTS</a> on <a href="#">page 297</a>	HSC dynamic status, which is continuously updated during HSC counting.
PIsData	Input	DINT UDINT	Programmable Limit Switch (PLS) data structure.

Sts	Output	UINT	HSC execution status. HSC status codes: <ul style="list-style-type: none"> <li>• 0x00 - No action taken (not enabled).</li> <li>• 0x01 - HSC execution successful.</li> <li>• 0x02 - HSC command invalid.</li> <li>• 0x03 - HSC ID out of range.</li> <li>• 0x04 - HSC configure error.</li> </ul>
ENO	Output	BOOL	Enable output. Applies only to Ladder Diagram programs.

### HSC Function Block Diagram example

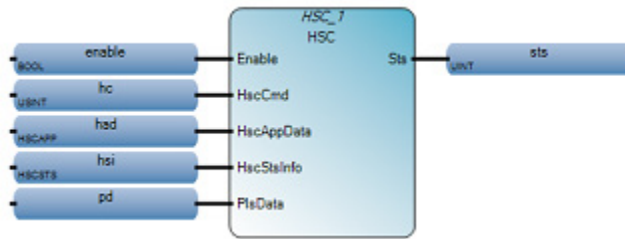

### HSC Ladder Diagram example

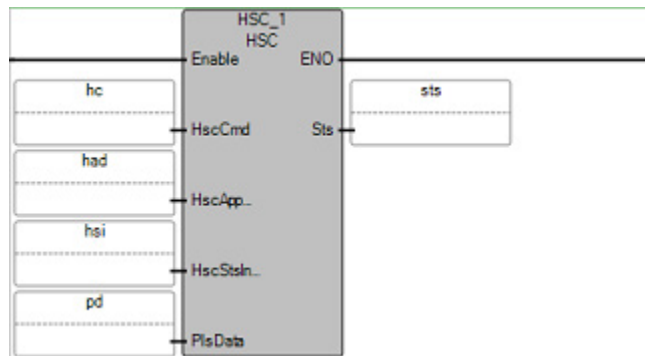

### HSC Structured Text example

```
HSC_1
void HSC_1(BOOL Enable, USINT HscCmd, HSCAPP HscAppData, HSCSTS HscStsInfo, PLS[1..1] PIsData)
Type : HSC, Apply high/low presets and output source to high-speed counter.

1 | HSC_1(enable, hc, had, hsi, pd);
2 | sts := HSC_1.Sts;
```

### HSCCmd values

The following table describes the HSC commands for each HSC command value.

HSC command	Command description
0x01	HSC RUN <ul style="list-style-type: none"> <li>• Start HSC (if HSC is in Idle mode and the rung is enabled).</li> <li>• Update HSC Status Information only (if HSC in Run mode and the rung is enabled).</li> </ul>

0x02	HSC Stop: Stop a HSC counting (if HSC is in Run mode and the rung is enabled).
0x03	HSC Load/Set: reload the HSC Application Data (if rung is enabled) for 6 input elements: HPSetting, LPSetting, HPOutput, LPOutput, OFSetting, and UFSSetting. <b>Note:</b> This command does not re-load the following input element: HSC accumulator.
0x04	HSC Accumulator Reset (if rung is enabled).

### HSC command results

Command value	Result	Conditions
HscCmd =1	Starts the HSC mechanism, and the HSC transitions to running mode.	Setting the Enable input parameter to False does not stop counting while in running mode. HscCmd =2 must be issued to stop counting.
	The HSC mechanism automatically updates values.	HSC AppData.Accumalator is updated with HSC Sts.Accumulator
HscCmd =4 (reset)	Sets the HSC Acc value to the HSC AppData.Accumalator value.	HscCmd =4 does not stop HSC counting. If HSC is counting when HscCmd =4 is issued, some counting may be lost  To set a specific value to HSC Acc while counting, write the value to HSC AppData.Accumalator immediately before HscCmd =4 is issued.

## HSCAPP data type

Use the HSCAPP data type to define the HSCAppData parameter in HSC instruction. The HSCApp data type parameters are used to define HSC configuration data.

Use this table to help determine the parameter values for the HSCAPP data type.

Parameter	Data Type	Data format	User program access	Description
PLSEnable	BOOL	bit	read/write	Enable or disable the High-Speed Counter Programmable Limit Switch (PLS).
HSCID	UINT	word	read/write	Defines the HSC.
HSCMode	UINT	word	read/write	Defines the HSC mode.
Accumulator	DINT	long word	read/write	Initial accumulator value. HSCApp.Accumulator sets the initial accumulator value when the High-Speed Counter starts. When the HSC is in Counting mode, the Accumulator is automatically updated by the HSC sub-system to reflect the actual HSC accumulator value.
HPSetting	DINT	long word	read/write	High preset setting. The HSCApp.HPSetting parameter sets the upper setpoint (in counts) that defines when the HSC sub-system generates an interrupt. The data loaded into the high preset must be less than or equal to the data resident in the overflow (HSCAPP.OFSetting) parameter or an HSC error is generated.

LPSetting	DINT	long word	read/write	<p>Low preset setting.</p> <p>HSCApp.LPSetting sets the lower setpoint (in counts) that defines when the HSC sub-system generates an interrupt.</p> <p>The data loaded into the low preset must be greater than or equal to the data resident in the underflow (HSCAPP.UFSetting) parameter or an HSC error is generated.</p> <p>If the underflow and low preset values are negative numbers, the low preset must be a number with an absolute value smaller than the underflow.</p>
OFSetting	DINT	long word	read/write	<p>Overflow setting.</p> <p>The HSCApp.OFSetting overflow setting defines the upper count limit for the counter.</p> <p>If the counter's accumulated value increments above the value specified in OFSetting, an overflow interrupt is generated.</p> <p>When the overflow interrupt is generated, the HSC sub-system resets the accumulator value to the underflow value and the counter continues counting from the underflow value (counts are not lost in this transition).</p> <p>OFSetting values must be:</p> <ul style="list-style-type: none"> <li>• Between -2,147,483,648 and 2,147,483,647.</li> <li>• Greater than the underflow value.</li> <li>• Greater than or equal to the data resident in the high preset (HSCAPP.HPSSetting) or an HSC error is generated.</li> </ul>
UFSetting	DINT	long word	read/write	<p>Underflow setting.</p> <p>The HSCApp.UFSetting underflow setting that defines the lower count limit for the counter.</p> <p>If the counter's accumulated value decrements below the value specified in UFSetting, an underflow interrupt is generated.</p> <p>When the underflow interrupt is generated, the HSC sub-system resets the accumulated value to the overflow value and the counter starts counting from the overflow value (counts are not lost in the transition).</p> <p>UFSetting values must be:</p> <ul style="list-style-type: none"> <li>• Between -2,147,483,648 and 2,147,483,647.</li> <li>• Less than the overflow value.</li> <li>• Less than or equal to the data resident in the low preset (HSCAPP.LPSSetting) or an HSC error is generated.</li> </ul>
OutputMask	UDINT	word	read/write	<p>Out mask for output.</p> <p>The HSCApp.OutputMask defines the embedded outputs on the controller that the High-Speed Counter can directly control. The HSC sub-system can, without control program interaction, turn outputs ON or OFF based on the High or Low presets of the HSC accumulator.</p> <p>The bit pattern stored in HSCApp.OutputMask defines which outputs are controlled by the HSC and which outputs are not controlled by the HSC.</p> <p>The HSCAPP.OutputMask bit pattern corresponds to the output bits on the controller and can only be configured during initial setup.</p> <p>Bits that are set (1) are enabled and can be turned on or off by the HSC sub-system.</p> <p>Bits that are set (0) cannot be turned on or off by the HSC sub-system.</p> <p>For example, to use the HSC to control outputs 0, 1, 3, assign:</p> <ul style="list-style-type: none"> <li>• HscAppData.OutputMask = 2#1011, or</li> <li>• HscAppData.OutputMask = 11</li> </ul>

HPOutput	UDINT	long word	read/write	32-bit output setting for High preset reaching. HSCApp.HPOutput defines the state (1 = ON or 0 = OFF) of the outputs on the controller when the high preset is reached. For more information on how to directly turn outputs on or off based on the high preset. Configure the high output bit pattern during initial setup, or you can use the HSC function block to load the new parameters while the controller is operating.
LPOutput	UDINT	long word	read/write	32-bit output setting for Low preset reaching. HSCApp.LPOutput defines the state (1 = "on", 0 = "off ") of the outputs on the controller when the low preset is reached. For more information on how to directly turn outputs on or off based on the low preset. Configure the low output bit pattern during initial setup, or you can use the HSC function block to load the new parameters while the controller is operating.

**HSCApp settings versus PLSData settings**

When the PLS function is enabled, relevant HSCApp settings are superseded by the corresponding PLSData settings as shown in the following table.

HSCApp setting	PLSData setting
HSCAPP.HpSetting	HSCHP
HSCAPP.LpSetting	HSCLP
HSCAPP.HPOutput	HSCHPOutput
HSCAPP.LPOutput	HSCLPOutput

**HSCApp.HSCID**

The HSCApp.HSCID parameter identifies the High-Speed Counter.

The following table lists the values for the HSCID:

Output Selection	Bit	Description
First word of HSC Function Data	15-13	Module type of HSC: <ul style="list-style-type: none"> <li>• 0x00 - Embedded.</li> <li>• 0x01 - Expansion.</li> <li>• 0x02 - Plug-in Port.</li> </ul>
	12-8	Slot ID of the module: <ul style="list-style-type: none"> <li>• 0x00 - Embedded.</li> <li>• 0x01-0x1F - ID of Expansion Module.</li> <li>• 0x01-0x05 - ID of Plug-in Port.</li> </ul>
	7-0	HSC ID inside the module: <ul style="list-style-type: none"> <li>• 0x00-0x0F - Embedded.</li> <li>• 0x00-0x07 - ID of HSC for Expansion.</li> <li>• 0x00-0x07 - ID of HSC for Plug-in Port.</li> </ul> For the initial version of Connected Components Workbench, only IDs 0x00-0x05 are supported.



## HSCApp.HSCMode

The HSCApp.HSCMode parameter sets the High-Speed Counter to one of 10 types of counting modes. The mode value is configured through the programming device and is accessible in the control program.

For additional information on HSC operating modes and input assignments, see HSC Inputs and Wiring Mapping in the *Micro830 and Micro850 Programmable Controllers User Manual*.

HSC operating modes, the main HSC and sub HSC support different modes.

- The main high-speed counters support 10 types of operation modes.
- Sub high-speed counters support 5 types of operation modes (mode 0, 2, 4, 6, 8).
- If the main high-speed counter is set to mode 1, 3, 5, 7 or 9, then the sub high-speed counter is disabled.

HSCMode	Counting mode
0	Up counter. The accumulator is immediately cleared (0) when it reaches the high preset. A low preset cannot be defined in this mode.
1	Up counter with external reset and hold. The accumulator is immediately cleared (0) when it reaches the high preset. A low preset cannot be defined in this mode.
2	Counter with external direction.
3	Counter with external direction, reset and hold.
4	Two input counter (up and down).
5	Two input counter (up and down) with external reset and hold.
6	Quadrature counter (phased inputs A and B).
7	Quadrature counter (phased inputs A and B) with external reset and hold.
8	Quadrature X4 counter (phased inputs A and B).
9	Quadrature X4 counter (phased inputs A and B) with external reset and hold.

## HSCAppData parameters example

The following image shows the HSCAppData parameters in the **Variable Selector**.

Name	Alias	Data Type	Dimension	Project Val	Initial Value
HSC_1		HSC		...	...
HSC_1.Enable	ENB	BOOL			
HSC_1.HscCmd	HscC	USINT			
HSC_1.HscAppData	HscA	HSCAPP		...	...
HSC_1.HscAppData.PlsEnable		BOOL			
HSC_1.HscAppData.HscID		UINT			
HSC_1.HscAppData.HscMode		UINT			
HSC_1.HscAppData.Accumulator		DINT			
HSC_1.HscAppData.HPSetting		DINT			
HSC_1.HscAppData.LPSetting		DINT			
HSC_1.HscAppData.OFSetting		DINT			
HSC_1.HscAppData.UFSetting		DINT			
HSC_1.HscAppData.OutputMask		UDINT			
HSC_1.HscAppData.HPOOutput		UDINT			
HSC_1.HscAppData.LPOOutput		UDINT			

## HSCSTS data type

HSCSTSInfo (data type HSCSTS) displays the status of the High-Speed

Counter.

### HSCSTSInfo status actions

During HSC counting, the following HSC status actions occur.

- If the HSC function block is counting with command 0x01, the HSC status is continuously updated.
- If an error occurs, the Error\_Detected flag is turned on and an error code is set.

### HSCSTSInfo parameters

Parameter	Data type	HSC mode	User program access	Description
CountEnable	BOOL	0...9	read only	Counting enabled.
ErrorDetected	BOOL	0...9	read/write	Non-zero means error detected.
CountUpFlag	BOOL	0...9	read only	Count up flag.
CountDwnFlag	BOOL	2...9	read only	Count down flag.
ModeIDone	BOOL	0 or 1	read/write	HSC is Mode 1A or Mode 1B; accumulator counts up to the HP value.
OVF	BOOL	0...9	read/write	Overflow is detected.
UNF	BOOL	0...9	read/write	Underflow is detected.
CountDir	BOOL	0...9	read only	1: count up; 0: count down.
HPReached	BOOL	2...9	read/write	High preset reached.
LPReached	BOOL	2...9	read/write	Low preset reached.
OFCauseInter	BOOL	0...9	read/write	Overflow caused a HSC interrupt.
UFCauseInter	BOOL	2...9	read/write	Underflow caused a HSC interrupt.
HPCauseInter	BOOL	0...9	read/write	High preset reached, causing a HSC interrupt.
LPCauseInter	BOOL	2...9	read/write	Low Preset reached, causing a HSC interrupt.
PLsPosition	UINT	0...9	read only	Position of the Programmable Limit Switch (PLS). The PLSPosition parameter is reset after completing a full cycle and reaching the HP value.
ErrorCode	UINT	0...9	read/write	Displays the error codes detected by the HSC sub-system.
Accumulator	DINT		read/write	Actual accumulator reading.
HP	DINT		read only	Last high preset setting.
LP	DINT		read only	Last low preset setting.
HPOutput	UDINT		read/write	Last high preset output setting.
LPOutput	UDINT		read/write	Last low preset output setting.

### HSCSTSInfo parameter details

HSCSTSInfo (data type HSCSTS) parameters are used to determine the status of the High-Speed Counter.

#### CountEnable

Parameter	Data type	HSC mode	User program access
HSCSTS.CountEnable	BOOL	0...9	read only

Indicates the status of the High-Speed Counter, whether counting is enabled (1) or disabled (0, default).

### ErrorDetected

Parameter	Data type	HSC mode	User program access
HSCSTS.ErrorDetected	BOOL	0...9	read/write

Detects if an error is present in the HSC sub-system. Configuration errors are the most common types of error represented by the ErrorDetecteddr. When the bit is set (1), look at the specific error code in parameter HSCSTS.ErrorCode, which is maintained by the controller. You can clear the ErrorDetected bit when necessary.

### CountUpFlag

Parameter	Data type	HSC mode	User program access
HSCSTS.CountUpFlag	BOOL	0...9	read only

Used with all of the HSCs (modes 0...9). If the HSCSTS.CountEnable bit is set, the Count Up bit is set (1). If the HSCSTS.CountEnable is cleared, the Count Up bit is cleared (0).

### CountDownFlag

Parameter	Data type	HSC mode	User program access
HSCSTS.CountDownFlag	BOOL	2...9	read only

Used with the bidirectional counters (modes 2...9). If the HSCSTS.CountEnable bit is set, the Count Down bit is set (1). If the HSCSTS.CountEnable bit is clear, the Count Down bit is cleared (0).

### Mode1Done

Parameter	Data type	HSC mode	User program access
HSCSTS.Mode1Done	BOOL	0 or 1	read/write

The HSC sub-system sets the HSCSTS.Mode1Done status flag to (1) when the HSC is configured for Mode 0 or Mode 1 behavior, and the accumulator counts up to the High Preset value.

### OVF

Parameter	Data type	HSC mode	User program access
HSCSTS.OVF	BOOL	0...9	read/write

The HSC sub-system sets the HSCSTS.OVF status flag to (1) whenever the accumulated value (HSCSTS.Accumulator) has counted through the overflow variable (HSCAPP.OFSetting). This bit is transitional and is set by the HSC sub-system. It is up to the control program to use, track, and clear (0) the overflow condition.

Overflow conditions do not generate a controller fault.

### UNF

Parameter	Data type	HSC mode	User program access
HSCSTS.UNF	BOOL	0...9	read/write

The HSC sub-system sets the HSCSTS.UNF status flag to (1) whenever the accumulated value (HSCSTS.Accumulator) has counted through the underflow variable (HSCAPP.UFSetting). This bit is transitional and is set by the HSC sub-system. It is up to the control program to use, track, and clear (0) the underflow condition.

Underflow conditions do not generate a controller fault.

**CountDir**

Parameter	Data type	HSC mode	User program access
HSCSTS.CountDir	BOOL	0...9	read only

The HSC sub-system controls the HSCSTS.CountDir status flag. When the HSC accumulator counts up, the direction flag is set to (1). Whenever the HSC accumulator counts down, the direction flag is cleared (0).

If the accumulated value stops, the direction bit retains its value. The only time the direction flag changes is when the accumulated count reverses.

This bit is updated continuously by the HSC sub-system whenever the controller is in a run mode.

**HPReached**

Parameter	Data type	HSC mode	User program access
HSCSTS.HPReached	BOOL	2...9	read/write

The HSC sub-system sets the HSCSTS.HPReached status flag to (1) whenever the accumulated value (HSCSTS.Accumulator) is greater than or equal to the high preset variable (HSCAPP.HPSSetting).

This bit is updated continuously by the HSC sub-system whenever the controller is in an executing mode. Writing to this element is not recommended.

**LPReached**

Parameter	Data type	HSC mode	User program access
HSCSTS.LPReached	BOOL	2...9	read only

The HSC sub-system sets the HSCSTS.LPReached status flag to (1) whenever the accumulated value (HSCSTS.Accumulator) is less than or equal to the low preset variable (HSCAPP.LPSetting).

This bit is updated continuously by the HSC sub-system whenever the controller is in an executing mode. Writing to this element is not recommended.

**OFCauseInter**

Parameter	Data type	HSC mode	User program access
HSCSTS.OFCauseInter	BOOL	0...9	read/write

The Overflow Interrupt status bit sets (1) when the HSC accumulator counts through the overflow value and the HSC interrupt is triggered. This bit can be used in the control program to identify that the overflow variable caused the HSC interrupt. If the control program needs to perform any specific control action based on the overflow, this bit is used as conditional logic.

This bit can be cleared (0) by the control program and is also cleared by the HSC sub-system whenever these conditions are detected:

- Low Preset Interrupt executes
- High Preset Interrupt executes
- Underflow Interrupt executes

#### UFCauseInter

Parameter	Data type	HSC mode	User program access
HSCSTS.UFCauseInter	BOOL	2...9	read/write

The Underflow Interrupt status bit sets (1) when the HSC accumulator counts through the underflow value and the HSC interrupt is triggered. This bit can be used in the control program to identify that the underflow condition caused the HSC interrupt. If the control program needs to perform any specific control action based on the underflow, this bit is used as conditional logic.

This bit can be cleared (0) by the control program and is also cleared by the HSC sub-system whenever these conditions are detected:

- Low Preset Interrupt occurs
- High Preset Interrupt occurs
- Overflow Interrupt occurs

#### HPCauseInter

Parameter	Data type	HSC mode	User program access
HSCSTS.HPCauseInter	BOOL	0...9	read/write

The High Preset Interrupt status bit sets (1) when the HSC accumulator reaches the high preset value and the HSC interrupt is triggered. This bit can be used in the control program to identify that the high preset condition caused the HSC interrupt. If the control program needs to perform any specific control action based on the high preset, this bit is used as conditional logic.

This bit can be cleared (0) by the control program and is also cleared by the HSC sub-system whenever these conditions are detected:

- Low Preset Interrupt occurs
- Underflow Interrupt occurs
- Overflow Interrupt occurs

### LPCauseInter

Parameter	Data type	HSC mode	User program access
HSCSTS.LPCauseInter	BOOL	2...9	read/write

The Low Preset Interrupt status bit sets (1) when the HSC accumulator reaches the low preset value and the HSC interrupt is triggered. This bit can be used in the control program to identify that the low preset condition caused the HSC interrupt. If the control program needs to perform any specific control action based on the low preset, this bit is used as conditional logic.

This bit can be cleared (0) by the control program and is also cleared by the HSC sub-system whenever these conditions are detected:

- High Preset Interrupt occurs
- Underflow Interrupt occurs
- Overflow Interrupt occurs

### PLSPosition

Parameter	Data type	HSC mode	User program access
HSCSTS.PLSPosition	UINT	0...9	read only

When the HSC is in Counting mode, and PLS is enabled, this parameter indicates which PLS element is used for the current HSC configuration.

### ErrorCode

Parameter	Data type	HSC mode	User program access
HSCSTS.ErrorCode	BOOL	0...9	read only

Displays the error codes detected by the HSC sub-system.

Error code sub-element	HSC counting error code	User program access
Bit 15-8 (high byte)	0-255	The non-zero value for the high byte indicates that the HSC error is due to the PLS data setting. The value of the high byte indicates which element of the PLS data triggers the error.
Bit 7-0 (low byte)	0x00	No error occurring.
	0x01	Invalid HSC counting mode.
	0x02	Invalid high preset.
	0x03	Invalid overflow.
	0x04	Invalid underflow.
	0x05	No PLS data.

### Accumulator

Parameter	Data type	User program access
HSCApp.Accumulator	DINT	read/write

Sets the initial accumulator value when the High-Speed Counter starts. When the HSC is in Counting mode, the Accumulator is automatically updated by the HSC sub-system to reflect the actual HSC accumulator value.

### HP

Parameter	Data type	User program access
HSCSTS.HP	DINT	read only

The HSCSTS.HP is the upper setpoint (in counts) that defines when the HSC sub-system generates an interrupt.

The data loaded into the high preset must be less than or equal to the data resident in the overflow (HSCAPP.OFSetting) parameter or an HSC error is generated.

This is the latest high preset setting, which may be updated by PLS function from the PLS data block.

### LP

Parameter	Data type	HSC mode	User program access
HSCSTS.LP	DINT		read only

The HSCSTS.LP is the lower setpoint (in counts) that defines when the HSC sub-system generates an interrupt.

The data loaded into the low preset must be greater than or equal to the data resident in the underflow (HSCAPP.UFSetting) parameter or an HSC error is generated. If the underflow and low preset values are negative numbers, the low preset must be a number with a smaller absolute value.

This is the latest low preset setting, which may be updated by PLS function from the PLS data block.

### HPOutput

Parameter	Data type	User program access
HSCApp.HPOutput	UDINT	read/write

Defines the state (1 = ON or 0 = OFF) of the outputs on the controller when the high preset is reached. For more information on how to directly turn outputs on or off based on the high preset.

You can configure the high output bit pattern during initial setup, or you can use the HSC function block to load the new parameters while the controller is operating.

### LPOutput

Parameter	Data type	User program access
HSCApp.LPOutput	UDINT	read/write

LPOutput (HSCApp.LPOutput) defines the state (1 = "on", 0 = "off") of the outputs on the controller when the low preset is reached. For more information on how to directly turn outputs on or off based on the low preset.

You can configure the low output bit pattern during initial setup, or you can use the HSC function block to load the new parameters while the controller is operating.

### HSCSTSInfo parameters example

The following image shows the HSCSTSInfo parameters in the **Variable Selector**.

Name	Alias	Data Type	Dimension	Project Val	Initial Value
HSC_1		HSC			
HSC_1.Enable	ENB	BOOL			
HSC_1.HscCmd	HscC	USINT			
HSC_1.HscAppData	HscA	HSCAPP			
HSC_1.HscSTSInfo	HscS	HSCSTS			
HSC_1.HscSTSInfo.CountEnable		BOOL			
HSC_1.HscSTSInfo.ErrorDetected		BOOL			
HSC_1.HscSTSInfo.CountUpFlag		BOOL			
HSC_1.HscSTSInfo.CountDwnFlag		BOOL			
HSC_1.HscSTSInfo.Mode1Done		BOOL			
HSC_1.HscSTSInfo.OVF		BOOL			
HSC_1.HscSTSInfo.UNF		BOOL			
HSC_1.HscSTSInfo.CountDir		BOOL			
HSC_1.HscSTSInfo.HPRReached		BOOL			
HSC_1.HscSTSInfo.LPRReached		BOOL			
HSC_1.HscSTSInfo.OFCauseInter		BOOL			
HSC_1.HscSTSInfo.UFCauseInter		BOOL			
HSC_1.HscSTSInfo.HPCauseInter		BOOL			
HSC_1.HscSTSInfo.LPCauseInter		BOOL			
HSC_1.HscSTSInfo.PlsPosition		UINT			
HSC_1.HscSTSInfo.ErrorCode		UINT			
HSC_1.HscSTSInfo.Accumulator		DINT			
HSC_1.HscSTSInfo.HP		DINT			
HSC_1.HscSTSInfo.LP		DINT			
HSC_1.HscSTSInfo.HPOutput		UDINT			
HSC_1.HscSTSInfo.LPOutput		UDINT			

### PLS data type

PLSData (data type PLS) is used to [configure the programmable limit switch](#) on [page 314](#).

### PLSData structure elements

The PLS data structure is a flexible array with the following elements.

Element	Element order	Data Type	Element description
HSCHP	Word 0...1	DINT	High preset
HSCLP	Word 2...3	DINT	Low preset
HSCHPOutput	Word 4...5	UDINT	Output high data
HSCLPOutput	Word 6...7	UDINT	Output low data

The total number of elements for one PLS data structure should not exceed 255.

### PLSData parameters

The following table lists the PLSData parameter details.

Element	Data Type	Data Format	HSC mode	User program access	Description
HSCHP	DINT	32-bit signed integer	0	read/writer	High preset
HSCLP	DINT	32-bit signed integer	0	read/writer	Low preset
HSCHPOutput	UDINT	32-bit binary	0	read/writer	Output high data



HSCLPOutput	UDINT	32-bit binary	0	read/writer	Output low data
-------------	-------	---------------	---	-------------	-----------------

### HSCApp settings versus PLSData settings

When the PLS function is enabled, relevant HSCApp settings are superseded by the corresponding PLSData settings as shown in the following table.

HSCApp setting	PLSData setting
HSCAPP.HpSetting	HSCHP
HSCAPP.LpSetting	HSCLP
HSCAPP.HPOOutput	HSCHPOOutput
HSCAPP.LPOOutput	HSCLPOOutput

### PLSData parameters example

The following figure shows the PLSData parameters in the **Variable Selector**.

Name	Alias	Data Type	Dimension	Project Value	Initial Value	Comment	String Size
HSC_1		HSC					
HSC_1.Enable	ENB	BOOL				Function block enable.	
HSC_1.HscCmd	HscC	USINT				See HSC Command Values.	
HSC_1.HscAppData	HscA	HSCAPP				HSC application configuration.	
HSC_1.HscStsInfo	HscS	HSCSTS				HSC dynamic status.	
HSC_1.PlsData	PlsD					Programmable Limit Switch (PLS) Data Structure	
HSC_1.PlsData[1]		PLS					
HSC_1.PlsData[1].HschP		DINT					
HSC_1.PlsData[1].HscLP		DINT					
HSC_1.PlsData[1].HschPO		UDINT					
HSC_1.PlsData[1].HscLPO		UDINT					
HSC_1._ADI_PlsData	_ADI	UINT			0	ADI hidden parameter for <PlsData> array input	
HSC_1.Sts	Sts	UINT				Execution status. See HSC Status Values.	

### HSCE\_CHANNEL data type

This describes the HSCE\_CHANNEL data type:

```
@typedef struct struct_HSCE_channel
{
    USINT    ModuleType;
    USINT    SlotID;
    USINT    HSCID;
} HSCE_CHANNEL;
```

Below is the description:

Byte	Description
Module Type	0x00: Embedded 0x01: Expansion (Sliced) 0x02: Universal Port
Slot ID	0x00: Embedded 0x01-0x1F: ID of Expansion (Sliced) Module 0x01-0x05: ID of Universal Port
HSCID	0x00-0x0F: Embedded 0x00-0x07: ID of <a href="#">HSC</a> on <a href="#">page 292</a> for Expansion 0x00-0x01: ID of HSC for Universal-Port

**HSCE\_STS data type**

Below is the description of HSCE\_STS data type:

Parameter	Data type	HSC mode	Description
CountEnable	BOOL	0...13	Counting enabled.
ErrorDetected	BOOL	0...13	Non-zero means error detected.
CountUpFlag	BOOL	0...13	Count up flag.
CountDwnFlag	BOOL	2...13	Count down flag.
Mode1Done	BOOL	0 or 1	HSC is Mode 1A or Mode 1B; accumulator counts up to the HP value.
OVF	BOOL	0...13	Overflow is detected.
UNF	BOOL	0...13	Underflow is detected.
CountDir	BOOL	0...13	1: count up; 0: count down.
HPReached	BOOL	2...13	High preset reached.
LPReached	BOOL	2...13	Low preset reached.
OFCauseInter	BOOL	0...13	Overflow caused a <a href="#">HSC</a> on <a href="#">page 292</a> interrupt.
UFCauseInter	BOOL	2...13	Underflow caused a HSC interrupt.
HPCauseInter	BOOL	0...13	High preset reached, causing a HSC interrupt.
LPCauseInter	BOOL	2...13	Low Preset reached, causing a HSC interrupt.
StateInfo	USINT		HSCE counter state machine information
PlsPosition	UINT	0...9	Position of the Programmable Limit Switch (PLS). The PlsPosition parameter is reset after completing a full cycle and reaching the HP value.
ErrorCode	UINT	0...13	Displays the error codes detected by the HSC sub-system.
Accumulator	DINT		Actual accumulator reading.
HP	DINT		Last high preset setting.
LP	DINT		Last low preset setting.
HPOutput	UDINT		Last high preset output setting.
LPOutput	UDINT		Last low preset output setting.

**PLS\_HSCE data type**

The Programmable Limit Switch function is an additional set of operating modes for the High Speed Counter. When operating in these modes, the preset and output data values are updated using user supplied data each time one of the presets is reached. These modes are programmed by providing a PLS file that contains the data sets to be used. PLS\_HSCE data structure is a flexible array with each element defined as following:

Element	Data Type	Element description
HighPreset	LINT	High preset setting
LowPreset	LINT	Low preset setting
HiPresetOutput	UDINT	High preset output data
LoPresetOutput	UDINT	Low preset output data

```
// structure for PLS element
typedef struct PLS_HSCE_EleStruct
{
    LINT HighPreset;        // HSC high preset value
    LINT LowPreset;        // HSC low preset value
    UDINT HiPresetOutput;  // HSC high preset output
    UDINT LoPresetOutput;  // HSC low preset output
} PLS_HSCE_EleStruct;
```

The total number of elements for one PLS\_HSCE data shall be not bigger than 24 for HSC plug-in.

### HSC\_SET\_STS (high-speed counter set status)

HSC\_SET\_STS manually sets or resets the HSC counting status.

Operation details:

- The HSC function block must be stopped (not counting) for the HSC\_SET\_STS function block to set or reset the HTS status. If HSC function is not stopped, the input parameters continue to update and changes made using HSC\_SET\_STS are ignored.

Languages supported: Function Block Diagram, Ladder Diagram, Structured Text.

This instructions applies to the Micro830, Micro850, and Micro870 controllers.

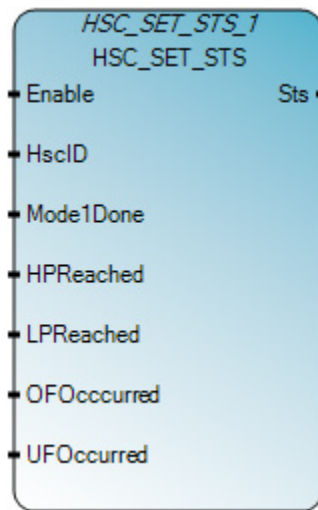

Use this table to help determine the parameter values for this instruction.

Parameter	Parameter Type	Data Type	Description
Enable	Input	BOOL	Instruction block enable. TRUE - set/reset the HSC status. FALSE - there is no HSC status change.
HscID	Input	UINT	Manually sets ore resets the HSC status.
Mode1Done	Input	BOOL	Mode 1A or 1B counting is done. This bit can be set or reset when HSC is not counting.
HPReached	Input	BOOL	High preset reached. This bit can be set or reset when HSC is not counting.
LPReached	Input	BOOL	Low preset reached. This bit can be set or reset when HSC is not counting.
OFOccurred	Input	BOOL	Overflow occurred. This bit can be set or reset when HSC is not counting.
UFOccurred	Input	BOOL	Underflow occurred. This bit can be set or reset when HSC is not counting.
Sts	Output	UINT	Status codes are defined in HSC status codes (Sts).
ENO	Output	BOOL	Enable output. Applies only to Ladder Diagram programs.

### HSC status codes (Sts)

The following table describes the status codes for the HSC function block.

Status code	Status description
0x00	No action taken (not enabled).
0x01	HSC execution successful.
0x02	HSC command invalid.
0x03	HSC ID out of range.
0x04	HSC configure error.

### HSC\_SET\_STS Function Block Diagram example

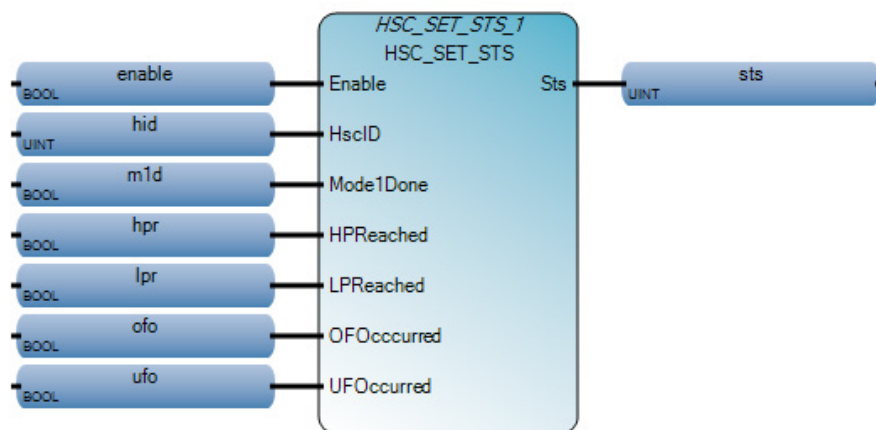

## HSC\_SET\_STS Ladder Diagram example

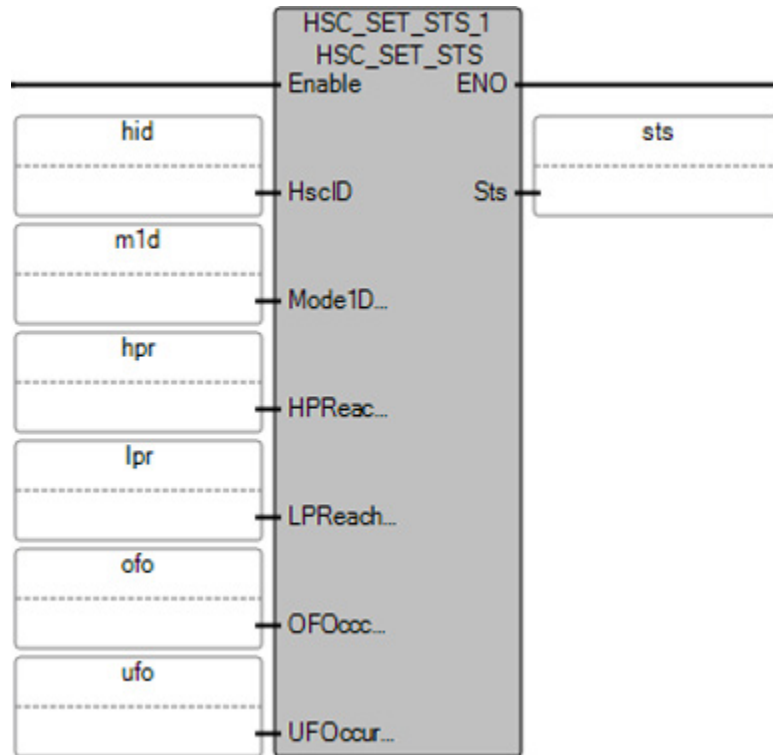

## HSC\_SET\_STS Structured Text example

```

HSC_SET_STS_1
void HSC_SET_STS_1(BOOL Enable, UINT HscID, BOOL Mode1Done, BOOL HPReached, BOOL LPReached, BOOL OFOccurred, BOOL UFOccurred)
Type: HSC_SET_STS, Manually set/reset HSC status.

1 HSC_SET_STS_1(enable, hid, m1d, hpr, lpr, ofo, ufo);
2 sts := HSC_SET_STS_1.Sts;

```

## Use the High-Speed Counter instructions

This section provides specific details and examples for using high-speed counter instructions in logic programs, including the following:

[Update HSC application data](#) on [page 309](#)

[Configure a High-Speed Counter \(HSC\) user interrupt](#) on [page 310](#)

[Configure a Programmable Limit Switch \(PLS\)](#) on [page 314](#)

[Example: How to create a High-Speed Counter\(HSC\)](#) on [page 315](#)

[Example: How to add a Programmable Limit Switch \(PLS\) function](#) on [page 323](#)

[Example: Programmable Limit Switch \(PLS\) enabled](#) on [page 325](#)

## Update HSC application data

HSC configuration is defined in the HSC application data, and is usually only configured once before programming the HSC instruction. Changes made to the HSC application data (HSCAppData parameter) are ignored while the HSC is counting.

## High-Speed Counter (HSC) User Interrupt dialog box

### To update the HSC configuration

1. Update HSCAppData.
2. Call the [HSC instruction](#) on [page 292](#) with command 0x03 (set/reload).

How do I open the High-Speed Counter (HSC) User Interrupt dialog box?

In Interrupt Type, select **High-Speed Counter (HSC) User Interrupt**.

Use the HSC interrupt dialog box to:

- [Configure the interrupt properties](#) on [page 310](#), such as ID and the program to use it in.
- Configure the interrupt parameters.

The screenshot shows a dialog box titled "Add Interrupt". It is divided into two main sections: "Interrupt Details" and "Parameters".

**Interrupt Details:**

- Type: High Speed Counter (HSC)
- Id: HSC0
- Program: RA\_MAX\_LD

**Parameters:**

- Auto Start
- Overflow Mask
- Underflow Mask
- High Preset Mask
- Low Preset Mask

At the bottom of the dialog box are four buttons: OK, Cancel, Apply, and Help.

## Configure a High-Speed Counter (HSC) User Interrupt

A user interrupt causes the controller to suspend the task it is currently performing, perform a different task, and then return to the suspended task at the point where the task was suspended.

Micro830, Micro850 and Micro870 controllers support up to six HSC User Interrupts that can be used to execute selected user logic at a pre-configured event.

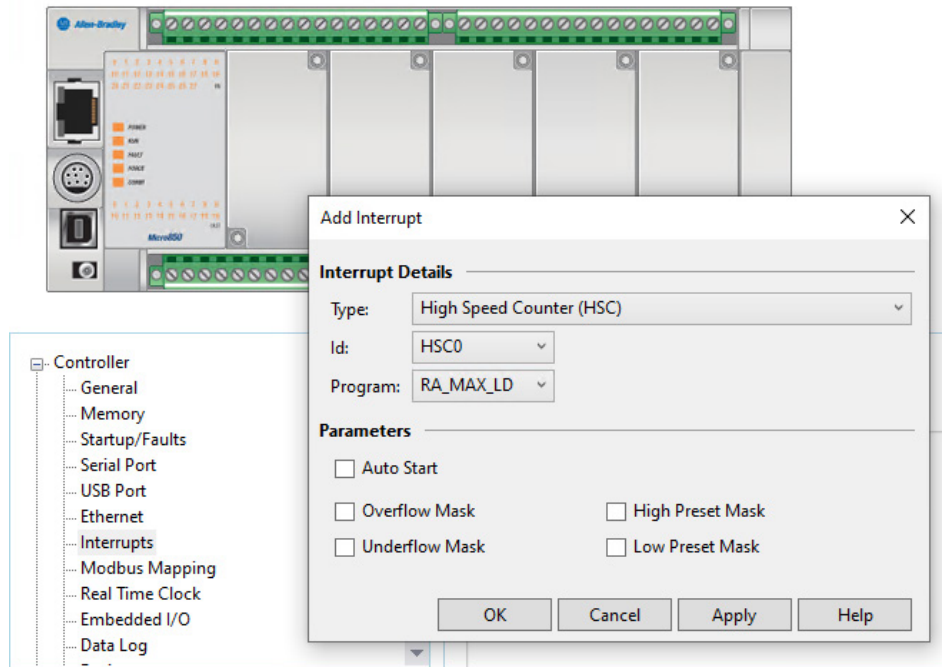

## Add and configure a High-Speed Counter (HSC) User Interrupt

To add and [configure a HSC interrupt](#) on [page 310](#) from the controller's configuration workspace, perform the following steps.

### To add an HSC interrupt:

1. In **Project Organizer**, double-click the controller to open the controller workspace.
2. In the **Controller** tree, click **Interrupts** to display the **Interrupt** configuration page.
3. Right-click an empty row, and click **Add** to open the **Interrupt** properties dialog box.
4. To configure an HSC interrupt:
  - In Interrupt Type, select **High-Speed Counter (HSC) User Interrupt**.
  - Select the [HSC Interrupt properties](#) on [page 311](#).
  - Select the [HSC Interrupt parameters](#) on [page 312](#).
5. Close the **Interrupt** properties dialog box.

## HSC Interrupt properties

The HSC Interrupt properties status bits indicate the enabled/disabled status, the execution status, and whether or not the interrupt condition is lost.

### User Interrupt Enable (HSC0.Enabled)

Parameter	Data format	HSC modes	User program access
HSC0.Enabled	bit	0...9	read only

Enabled bit is used to indicate HSC interrupt enable or disable status.

### User Interrupt Executing (HSCO.EX)

Parameter	Data format	HSC modes	User program access
HSCO.Ex	bit	0...9	read only

The EX (User Interrupt Executing) bit is set (1) whenever the HSC sub-system begins processing the HSC subroutine due to any of the following conditions:

- Low preset reached
- High preset reached
- Overflow condition - count up through the overflow value
- Underflow condition - count down through the underflow value

The HSC EX bit can be used in the control program as conditional logic to detect if an HSC interrupt is executing.

The HSC sub-system will clear (0) the EX bit when the controller completes its processing of the HSC subroutine.

### User Interrupt Pending (HSCO.PE)

Parameter	Data format	HSC modes	User program access
HSCO.PE	bit	0...9	read only

The PE (User Interrupt Pending) status flag indicates an interrupt is pending. The PE status bit can be monitored or used for logic purposes in the control program if you need to determine when a subroutine cannot be immediately executed. The PE bit is maintained by the controller and is set and cleared automatically.

### User Interrupt Lost (HSCO.LS)

Parameter	Data format	HSC modes	User program access
HSCO.LS	bit	0...9	read only

The LS (User Interrupt Lost) is a status flag that indicates an interrupt has been lost. The controller can process 1 active user interrupt condition and maintain 1 pending user interrupt condition before it sets the lost bit.

The LS bit is set by the controller. It is up to the control program to use and monitor a lost condition.

## HSC Interrupt parameters

The HSC interrupt parameters are used to configure the start and mask options.

### Auto Start (HSCO.AS)

Parameter	Data format	HSC modes	User program access
-----------	-------------	-----------	---------------------



HSCO.AS	bit	0...9	read only
---------	-----	-------	-----------

Auto Start is configured with the programming device and stored as part of the user program. The auto start bit defines if the HSC interrupt function automatically starts whenever the controller enters any run or test mode.

### Overflow Mask (HSCO.MV)

The **MV** (Overflow Mask) control bit is used to enable (allow) or disable (not allow) an overflow interrupt from occurring. If the bit is clear (0), and an **Overflow Reached** condition is detected by the **HSC**, the **HSC** user interrupt is not executed.

The **MV** bit is controlled by the user program and retains its value through a power cycle. The user program must set and clear the **MV** bit.

Parameter	Data format	HSC modes	User program access
HSCO.MV	bit	0...9	read only

### Underflow Mask (HSCO.MN)

Parameter	Data format	HSC modes	User program access
HSCO.MN	bit	2...9	read only

The **MN** (Underflow Mask) control bit is used to enable (allow) or disable (not allow) an underflow interrupt from occurring. If the bit is clear (0), and an Underflow Reached condition is detected by the HSC, the HSC user interrupt is not executed.

The **MN** bit is controlled by the user program and retains its value through a power cycle. The user program must set and clear the **MN** bit.

### High Preset Mask (HSCO.MH)

Parameter	Data format	HSC modes	User program access
HSCO.MH	bit	0...9	read only

The **MH** (High Preset Mask) control bit is used to enable (allow) or disable (not allow) a high preset interrupt from occurring. If this bit is clear (0), and a High Preset Reached condition is detected by the HSC, the HSC user interrupt is not executed.

The **MH** bit is controlled by the user program and retains its value through a power cycle. The user program must set and clear the **MH** bit.

### Low Preset Mask (HSCO.ML)

Parameter	Data format	HSC modes	User program access
-----------	-------------	-----------	---------------------

HSCO.ML	bit	2...9	read only
---------	-----	-------	-----------

The ML (Low Preset Mask) control bit is used to enable (allow) or disable (not allow) a low preset interrupt from occurring. If this bit is clear (0), and a Low Preset Reached condition is detected by the HSC, the HSC user interrupt is not executed.

The ML bit is controlled by the user program and retains its value through a power cycle. The user program must set and clear the ML bit.

## Configure a Programmable Limit Switch (PLS)

The [high-speed counter](#) on [page 292](#) has additional operating modes for implementing a Programmable Limit Switch (PLS). The PLS function is used to configure the High-Speed Counter to operate as a PLS or as a rotary cam switch. The PLS function supports up to 255 pairs of high and low presets, and can be used when you need more than one pair of high and low presets.

### Enabling PLS in the HSC

The PLS mode only operates in tandem with the HSC of the Micro800 controller, and must be enabled in the HSC instruction by setting the HSCAppData.PLSEnable parameter to True.

The PLSPosition parameter is reset after completing a full cycle and reaching the HSCSTS.HP value. Resetting the HSC instruction or moving 0 to the PLSPosition parameter does not reset the PLSPosition.

### HSC operation when PLS is enabled

The PLS function can operate with all other HSC capabilities, including the ability to select which HSC events generate a user interrupt.

[When the PLS function is enabled](#) on [page 325](#), and the controller is in run mode, the HSC counts incoming pulses, and the following events occur.

- When the count reaches the first preset (HSCHP or HSCLP) defined in the PLS data, the output source data (HSCHPOutput or HSCLPOutput) is written through the HSC mask (HSCAPP.OutputMask).
- At that point, the next presets (HSCHP and HSCLP) defined in the PLS data become active.
- When the HSC counts to the new preset, the new output data is written through the HSC mask.
- This process continues until the last element within the PLS data block is loaded.
- At that point the active element within the PLS data block is reset to zero.
- This behavior is referred to as circular operation.

## The PLS preset difference between embedded HSC and plug-in HSC module

The PLS HSCHP and HSCLP preset behaviors are different between embedded HSC and plug-in HSC module. The embedded HSC High Preset bit will be set only when the last PLS is executed, while the plug-in HSC module High Preset bit will be set when first PLS is executed. For example,

- Embedded HSC PLS<sub>0</sub>-PLS<sub>23</sub>:  
High Preset will be set when PLS<sub>23</sub>HP=Accumulator value  
Low Preset will be set when PLS<sub>23</sub>LP=Accumulator value
- Plug-in HSC PLS<sub>0</sub>-PLS<sub>23</sub>:  
High Preset will be set when PLS<sub>0</sub>HP=Accumulator value  
Low Preset will be set when PLS<sub>0</sub>LP=Accumulator value

### Example: How to create a High-Speed Counter (HSC) program

This example shows how to create a [High-Speed Counter \(HSC\)](#) on [page 292](#) program that uses a quadrature encoder and includes a Programmable Limit Switch (PLS) function.

### Quadrature encoder used in the example

The High Speed Counter program example uses an HSC function block and a quadrature counter with phased inputs A and B. The quadrature encoder determines the direction of rotation and the position for rotating equipment, such as a lathe. The Bidirectional Counter counts the rotation of the quadrature encoder.

The following quadrature encoder is connected to inputs 0 and 1. The count direction is determined by the phase angle between A and B:

- If A leads B, the counter increments.
- If B leads A, the counter decrements.

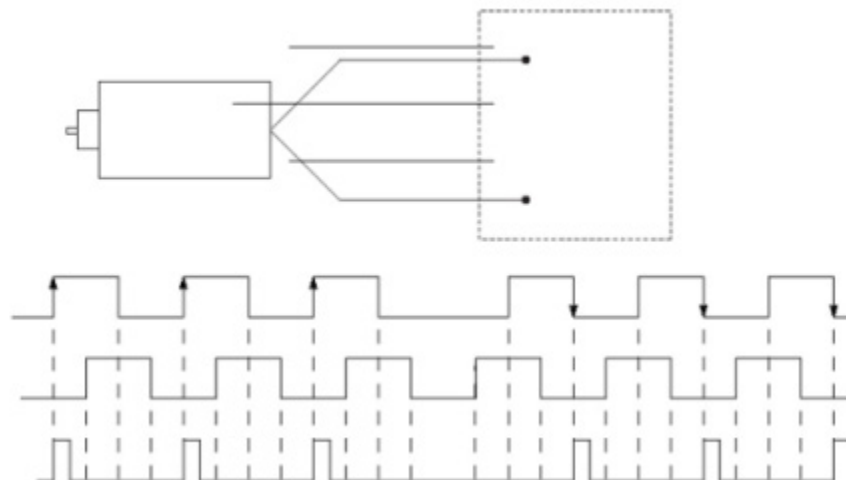

## Create a High-Speed Counter (HSC) program

Perform the following tasks to create, build, and test the HSC program, and then add a PLS function.

Step	Task
1	<a href="#">Create a ladder diagram and add variables</a> on <a href="#">page 316</a>
2	<a href="#">Assign values to the HSC variables</a> on <a href="#">page 319</a>
3	<a href="#">Assign variables and build the program</a> on <a href="#">page 320</a>
4	<a href="#">Test the program and run the High-Speed Counter</a> on <a href="#">page 321</a>
5	<a href="#">Add a Programmable Limit Switch (PLS) function</a> on <a href="#">page 323</a>

### Create a ladder diagram and add variables

Create a ladder diagram and then add local variables to the rung. This sample program uses a 2080-LC50-24QVB controller. The [HSC](#) on [page 292](#) is supported on all Micro830 and Micro850 controllers except 2080-LCxx-xxAWB controller types.

#### To create a ladder diagram and add variables:

1. In the **Device Toolbox**, expand the **Catalog** tab to view the device folders.

- Expand the Controllers folder and the Micro830 folder to view all Micro830 controllers. Double-click a controller (2080-LC50-24QVB) to add it to the **Project Organizer**.

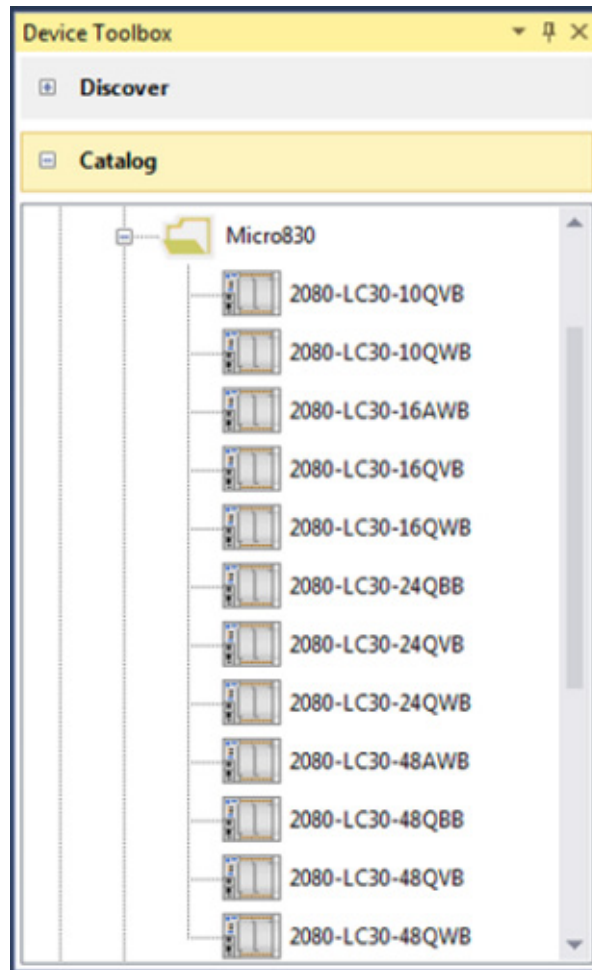

- In the **Project Organizer**, right-click **Programs**, click **Add**, and then click **New LD: Ladder Diagram** to add a new ladder logic program.
- Right-click **UntitledLD** and select **Open**.
- In the **Toolbox** dialog box.
  - Double-click **Direct Contact** to add it to the rung, or
  - Drag and drop a **Direct Contact** onto the rung.

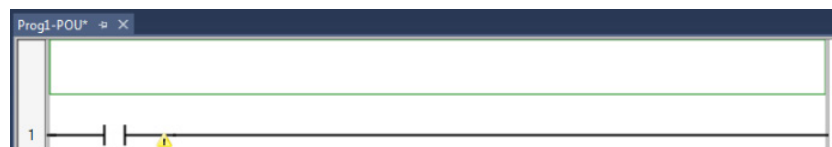

- Assign a variable to the direct contact:
  - Double-click on the direct contact to display the **Variable Selector**, and then click the **I/O - Micro830** tab.

- Click **\_IO\_EM\_DI\_05**, and then click **OK** to assign the direct contact to input 5.

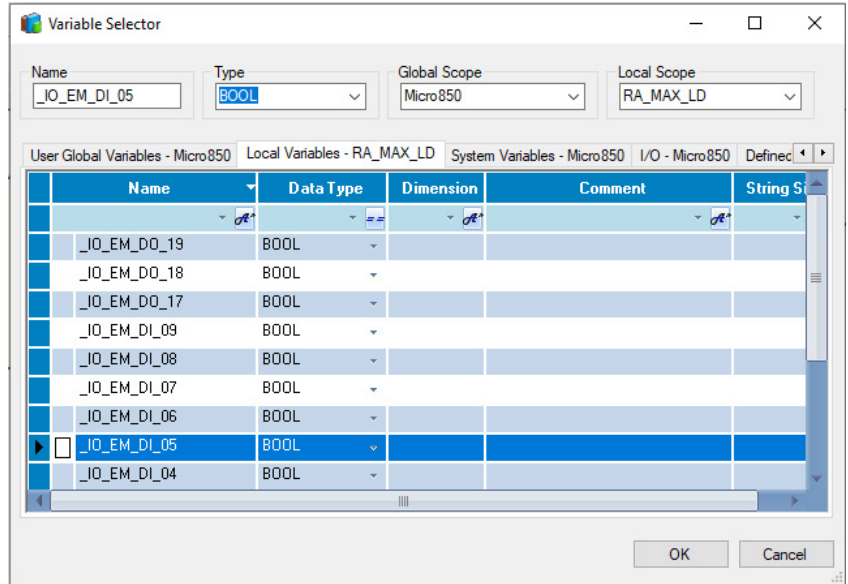

- In the **Toolbox** dialog box, select a function block and drag it to the right of the direct contact as shown in the following image.

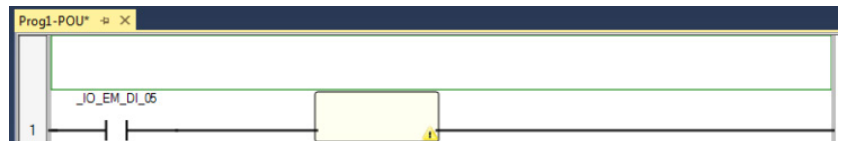

- Double-click the function block to open the **Instruction Block Selector**.
- In the **Instruction Block Selector**, select **HSC** and click **OK**.
- Verify the ladder rung looks similar to the following figure.

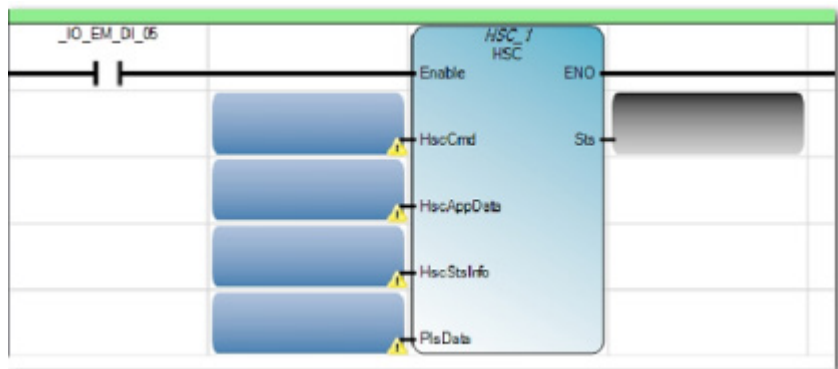

- In the **Project Organizer**, double-click **Local Variables** to display the **Variables** page.
- In the **Variables** page, add the following variables and data types.

Variable Name	Data Type
MyCommand	USINT
MyAppData	HSCAPP
MyInfo	HSCSTS
MyPLS	PLS
MyStatus	UINT

## Result

The **Variables** page should look like the image below:

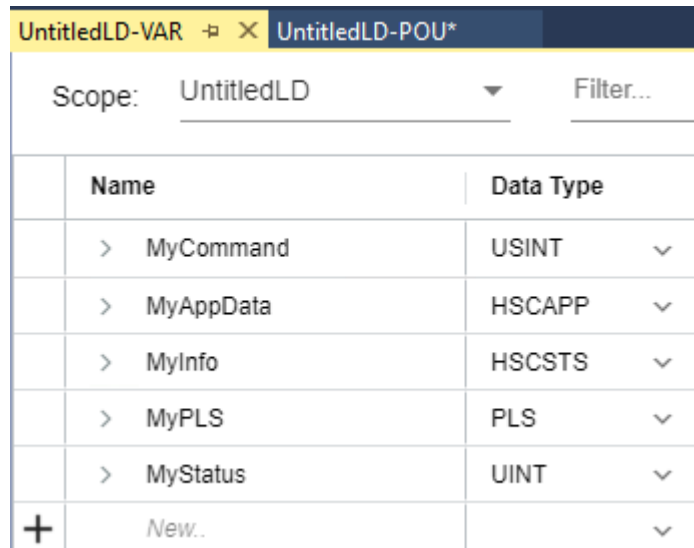

## Assign values to the HSC variables

After you add variables, follow these steps to add values to the variables using the Initial Value column in the **Variable Selector**. A standard program usually uses a routine to assign values to the variables.

### To assign values to the HSC variables:

- Expand **MyAppData** to view all variables.
- Assign the HSC mode value:
  - In the **Initial Value** field for the MyAppData.HSCMode variable, type 6.
  - See HSCMode in [HSCAPP data type](#) on [page 294](#) for more information on the description for each value.
- Assign the rest of the values to the MyAppData variables as shown in the following figure.
  - In the **Initial Value** field, enter the value.
  - See [HSCAPP data](#) on [page 294](#) type for more information on the description for each value.

Name	Alias	Data Type	Dimension	Project Value	Initial Value
MyAppData		HSCAPP		...	...
MyAppData.PlsEnable		BOOL			FALSE
MyAppData.HscID		UINT			0
MyAppData.HscMode		UINT			6
MyAppData.Accumulator		DINT			
MyAppData.HPSetting		DINT			40
MyAppData.LPSetting		DINT			-40
MyAppData.OFSetting		DINT			50
MyAppData.UFSetting		DINT			-50
MyAppData.OutputMask		UDINT			3
MyAppData.HPOutput		UDINT			1
MyAppData.LPOutput		UDINT			2

- Assign the HSC command value:

- In the **Initial Value** field for the MyCommand variable, type 1.
- See [HSCCmd values](#) on [page 293](#) for more information on command values.

## Assign variables and build the program

After you enter values in the HSC variables, follow these steps to assign the variables to the function block, and build the program.

### To assign variables and build the program:

1. From the Ladder Diagram editor, assign each variable to the HSC function block element as shown.

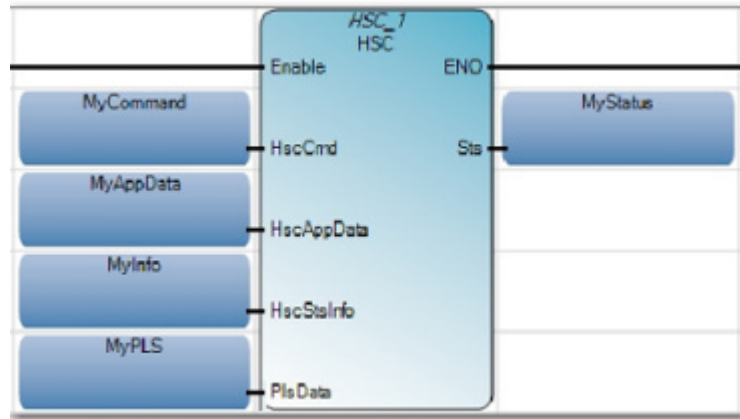

2. From **Project Organizer**, click the controller to display the **Controller** tree.

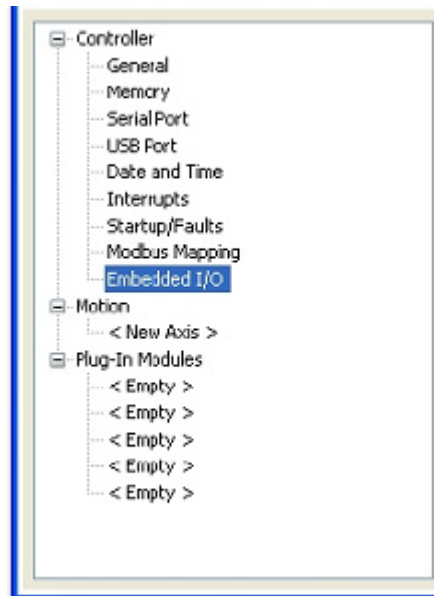



- From the **Controller** tree, click **Embedded I/O**, and select input filters for the encoder.

Controller - Embedded I/O

Input Filter		Input Latch and EII Edge		
Inputs	Input Filter	Input	Enable Latch	EII Edge
0-1	Default	0	<input type="checkbox"/>	Falling
2-3	Default	1	<input type="checkbox"/>	Falling
4-5	Default	2	<input type="checkbox"/>	Falling
6-7	Default	3	<input type="checkbox"/>	Falling
8-9	Default	4	<input type="checkbox"/>	Falling
10-11	Default	5	<input type="checkbox"/>	Falling
12-13	Default	6	<input type="checkbox"/>	Falling
14-15	Default	7	<input type="checkbox"/>	Falling
16-23	Default	8	<input type="checkbox"/>	Falling
24-27	Default	9	<input type="checkbox"/>	Falling
		10	<input type="checkbox"/>	Falling

- Verify the encoder is connected to the Micro830 controller.
- Start the Micro830 controller and connect the controller to your computer.
- Build the program and then download the program to the controller.

## Test the program and run the High-Speed Counter

After you download the HSC program to the controller, you can test it and then run the High-Speed Counter.

### To test the program:

- Connect to the Controller.
- From the **Project Organizer**, double-click the HSC program, then double-click **Local Variables**.

You can see the values of the two HSC outputs: STS (MyStatus) and HSCSTS (MyInfo).

- Double-click the `_IO_EM_DI_05` direct contact to display the **Variable Selector** window.
- Click the **I/O Micro830** tab, and then click the `_IO_EM_DI_05` row.

- Select **Lock** and **Logical Value** to force the input to the **ON** position.

Name	Alias	Logical Value	Physical Value	Initial Value	Lock	Data Type	Dimension
_JO_EM_DO_00		<input type="checkbox"/>	<input type="checkbox"/>		<input type="checkbox"/>	BOOL	-
_JO_EM_DO_01		<input type="checkbox"/>	<input type="checkbox"/>		<input type="checkbox"/>	BOOL	-
_JO_EM_DO_02		<input type="checkbox"/>	<input type="checkbox"/>		<input type="checkbox"/>	BOOL	-
_JO_EM_DO_03		<input type="checkbox"/>	<input type="checkbox"/>		<input type="checkbox"/>	BOOL	-
_JO_EM_DO_04		<input type="checkbox"/>	<input type="checkbox"/>		<input type="checkbox"/>	BOOL	-
_JO_EM_DO_05		<input type="checkbox"/>	<input type="checkbox"/>		<input type="checkbox"/>	BOOL	-
_JO_EM_DO_06		<input type="checkbox"/>	<input type="checkbox"/>		<input type="checkbox"/>	BOOL	-
_JO_EM_DO_07		<input type="checkbox"/>	<input type="checkbox"/>		<input type="checkbox"/>	BOOL	-
_JO_EM_DO_08		<input type="checkbox"/>	<input type="checkbox"/>		<input type="checkbox"/>	BOOL	-
_JO_EM_DO_09		<input type="checkbox"/>	<input type="checkbox"/>		<input type="checkbox"/>	BOOL	-
_JO_EM_DI_00		<input type="checkbox"/>	<input type="checkbox"/>		<input type="checkbox"/>	BOOL	-
_JO_EM_DI_01		<input type="checkbox"/>	<input type="checkbox"/>		<input type="checkbox"/>	BOOL	-
_JO_EM_DI_02		<input type="checkbox"/>	<input type="checkbox"/>		<input type="checkbox"/>	BOOL	-
_JO_EM_DI_03		<input type="checkbox"/>	<input type="checkbox"/>		<input type="checkbox"/>	BOOL	-
_JO_EM_DI_04		<input type="checkbox"/>	<input type="checkbox"/>		<input type="checkbox"/>	BOOL	-
_JO_EM_DI_05		<input checked="" type="checkbox"/>	<input checked="" type="checkbox"/>		<input checked="" type="checkbox"/>	BOOL	-
_JO_EM_DI_06		<input type="checkbox"/>	<input type="checkbox"/>		<input type="checkbox"/>	BOOL	-
_JO_EM_DI_07		<input type="checkbox"/>	<input type="checkbox"/>		<input type="checkbox"/>	BOOL	-
_JO_EM_DI_08		<input type="checkbox"/>	<input type="checkbox"/>		<input type="checkbox"/>	BOOL	-
_JO_EM_DI_09		<input type="checkbox"/>	<input type="checkbox"/>		<input type="checkbox"/>	BOOL	-

- To view results, click the **Local Variables** tab to view variable changes.
- Expand **MyAppData** and **MyInfo** variable list.
- Turn on the encoder to see the counter count up/down. For example, if the encoder is attached to a motor shaft, then turn on the motor to trigger the HSC count.
- Verify the Logical Value of in the MyStatus variable is 1, which indicates the HSC is running.
- View the counter value in MyInfo.Accumulator.

See [HSC \(high-speed counter\)](#) on [page 292](#) for the complete list of status codes.

## Results

In this example, once MyInfo.Accumulator reaches a High Preset value of 40, output 0 turns on and the HPRReached flag turns on. If MyInfo.Accumulator reaches a Low Preset value of -40, output 1 turns on and the LPRReached flag turns on.

Name	Logical Value	Physical Value
HSC_1	...	...
MyAppData	...	...
MyAppData.PlsEnab	<input type="checkbox"/>	N/A
MyAppData.HscID	0	N/A
MyAppData.HscMoc	7	N/A
MyAppData.Accumu	40	N/A
MyAppData.HPSettir	40	N/A
MyAppData.LPSettir	-40	N/A
MyAppData.OFSettir	50	N/A
MyAppData.UFSettir	-50	N/A
MyAppData.OutputM	3	N/A
MyAppData.HPOutp	1	N/A
MyAppData.LPOutp	2	N/A
MyCommand	0	N/A
MyInfo	...	...
MyInfo.CountEnable	<input checked="" type="checkbox"/>	N/A
MyInfo.ErrorDetector	<input type="checkbox"/>	N/A
MyInfo.CountUpFlag	<input checked="" type="checkbox"/>	N/A
MyInfo.CountDwnFlg	<input checked="" type="checkbox"/>	N/A
MyInfo.Mode1Done	<input type="checkbox"/>	N/A
MyInfo.OVF	<input type="checkbox"/>	N/A
MyInfo.UNF	<input type="checkbox"/>	N/A
MyInfo.CountDir	<input checked="" type="checkbox"/>	N/A
MyInfo.HPRReached	<input checked="" type="checkbox"/>	N/A
MyInfo.LPRReached	<input type="checkbox"/>	N/A
MyInfo.OFCauseInte	<input type="checkbox"/>	N/A
MyInfo.UFCauseInte	<input type="checkbox"/>	N/A
MyInfo.HPCauseInte	<input type="checkbox"/>	N/A
MyInfo.LPCauseInte	<input type="checkbox"/>	N/A
MyInfo.PlsPosition	0	N/A
MyInfo.ErrorCode	0	N/A
MyInfo.Accumulator	40	N/A
MyInfo.HP	40	N/A
MyInfo.LP	-40	N/A
MyInfo.HPOutput	1	N/A
MyInfo.LPOutput	2	N/A
MyPLS	...	...
MyStatus	1	N/A

### Add a Programmable Limit Switch (PLS) function

This example explains how to add a Programmable Limit Switch (PLS) function to the HSC program.

Variable values for the counter settings:

- **MyAppData.PlsEnable** is used to enable or disable the PLS settings. It should be set to FALSE (disabled) if the MyAppData variable is used.
- **MyAppData.HscID** is used to specify which embedded inputs will be used based on the mode and application type. See HSC Inputs and Wiring Mapping to know the different IDs that can be used as well as the embedded inputs and its characteristics.
- If ID 0 is used, ID 1 cannot be used on the same controller because the inputs are used by Reset and Hold.
- **MyAppData.HscMode** is used to specify the type of operation the HSC uses to count. See [HSC Mode \(HSCAPP.HSCMode\)](#) on [page 294](#).

### To enable PLS:

1. In **Project Organizer**, double-click **Local Variables** to display the **Variables** page.
2. Enable the PLS function:
  - In the Initial Value field for the MyAppData.PlsEnable variable, select TRUE.
3. Configure the underflow and overflow settings:
  - In the Initial Value field for MyAppData.OFSetting, type 50.
  - In the Initial Value field for MyAppData.UFSetting, type -50.
4. (optional) Configure the output mask if an output.

Results for this example:

- The PLS variable has a dimension of [1..4]. This means that HSC can have four pairs of High and Low Presets.
- High Preset values should be lower than the OFSetting and the Low Preset should be greater than the UFSetting.

- The HscHPOutPut and HscLPOutPut values determine which outputs are turned on when a High Preset or Low Preset is reached.

Name	Alias	Data Type	Dimension	Project Val	Initial Value
MyPLS		PLS	[1..4]	...	...
MyPLS[1]		PLS		...	...
MyPLS[1].HscHP		DINT			10
MyPLS[1].HscLP		DINT			-10
MyPLS[1].HscHPOutPut		UDINT			1
MyPLS[1].HscLPOutPut		UDINT			16
MyPLS[2]		PLS		...	...
MyPLS[2].HscHP		DINT			20
MyPLS[2].HscLP		DINT			-20
MyPLS[2].HscHPOutPut		UDINT			2
MyPLS[2].HscLPOutPut		UDINT			32
MyPLS[3]		PLS		...	...
MyPLS[3].HscHP		DINT			30
MyPLS[3].HscLP		DINT			-30
MyPLS[3].HscHPOutPut		UDINT			4
MyPLS[3].HscLPOutPut		UDINT			64
MyPLS[4]		PLS		...	...
MyPLS[4].HscHP		DINT			40
MyPLS[4].HscLP		DINT			-40
MyPLS[4].HscHPOutPut		UDINT			8
MyPLS[4].HscLPOutPut		UDINT			128

### Example: Programmable Limit Switch (PLS) enabled

This example describes the results when PLS is enabled using specific [HSC](#) on [page 292](#) and PLSData parameter values.

### HSC parameter values

This example assumes the HSC parameters are set to the following values:

- HSCApp.OutputMask = 31
- HSCApp.HSCMode = 0
- HSC controls Embedded Output o...4 only

### PLSData parameter values

This example assumes the PLSData parameters for the variable (HSC\_PLS) are configured as follows.

Name	Alias	Data Type	Dimension	Project Value	Initial Value
HSC_1		HSC		...	...
HSC_PLS		PLS	[1..4]	...	...
HSC_PLS[1]		PLS		...	...
HSC_PLS[1].HscHP		DINT			250
HSC_PLS[1].HscLP		DINT			-2
HSC_PLS[1].HscHPOutPut		UDINT			3
HSC_PLS[1].HscLPOutPut		UDINT			0
HSC_PLS[2]		PLS		...	...
HSC_PLS[2].HscHP		DINT			500
HSC_PLS[2].HscLP		DINT			-2
HSC_PLS[2].HscHPOutPut		UDINT			7
HSC_PLS[2].HscLPOutPut		UDINT			0
HSC_PLS[3]		PLS		...	...
HSC_PLS[3].HscHP		DINT			750
HSC_PLS[3].HscLP		DINT			-2
HSC_PLS[3].HscHPOutPut		UDINT			15
HSC_PLS[3].HscLPOutPut		UDINT			0
HSC_PLS[4]		PLS		...	...
HSC_PLS[4].HscHP		DINT			1000
HSC_PLS[4].HscLP		DINT			-2
HSC_PLS[4].HscHPOutPut		UDINT			31
HSC_PLS[4].HscLPOutPut		UDINT			0

### PLS enabled results

For this example, the following events occur.

- When the ladder logic first runs: HSCSTS.Accumulator = 1, which means all outputs are turned off.
- When HSCSTS.Accumulator = 250, HSC\_PLS[1].HscHPOutput is sent through the HSCAPP.OutputMask, and energizes outputs 0 and 1.
- Sending the high preset output through the output mask repeats as the HSCSTS.Accumulator reaches 500, 750, and 1000, and the controller energizes outputs 0...2, 0...3, and 0...4 respectively.
- After the operation completes, the cycle resets and repeats from HSCSTS.HP = 250.
- When the full cycle completes and the HSCSTS.HP value is reached the PLSPosition parameter is reset.

## HSCE instructions

Use HSCE instructions to monitor and control the high-speed counter.

Instruction	Description
<a href="#">HSCE</a> on <a href="#">page 327</a>	HSCE start, stop and read accumulator value.
<a href="#">HSCE_CFG</a> on <a href="#">page 330</a>	HSCE_CFG is the high speed counter configuration.
<a href="#">HSCE_CFG_PLS</a> on <a href="#">page 332</a>	HSCE_CFG_PLS is the high speed counter PLS configuration.
<a href="#">HSCE_READ_STS</a> on <a href="#">page 335</a>	HSCE_READ_STS reads high speed counter status.
<a href="#">HSCE_SET_STS</a> on <a href="#">page 327</a>	HSCE_SET_STS manually set/reset high speed counter status.

### HSCE

HSCE is used for controlling and reading the HSC counter.

Languages supported: Function Block Diagram, Ladder Diagram, Structured Text.

This instruction applies to the Micro820, Micro830, Micro850, and Micro870 controllers.

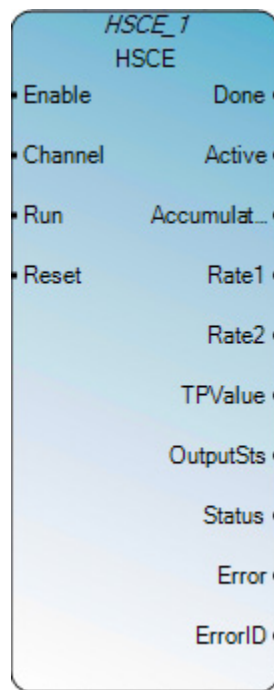

Use this table to help determine the parameter values for this instruction.

Parameter	Parameter Type	Data Type	Description
Enable	Input	BOOL	TRUE - the HSCE initiates the function block and the plug-in HSC module. Accumulator = InitAcc. Status of HSCE will be reset. Rate1 = 0, Rate2 = 0. FALSE - the Accumulator is updated by reading from the plug-in module. Done, Active, Error = FALSE while ErrorID = 0, Rate1, Rate2 = 0.

## Chapter 15 HSCE instructions

Channel	Input	HSCE_CHANNEL	The HSCE channel.
Run	Input	BOOL	For HSCE to count the operational state. TRUE - HSCE counts the pulses. FALSE - HSCE stops the counting.
Reset	Input	BOOL	True - all outputs are cleared and accumulator. Rate1 and Rate2 are also cleared to 0. Plug-in HSC module status clear. The priority of Reset input is higher than the input of Run
Done	Output	BOOL	True - when HSCE Enable is True and no error is detected False - when HSCE Enable is True but Run is False.
Active	Output	BOOL	True - when HSCE Enable is True, Done is True and Run is False. False - when HSCE Enable is True but Run is False.
Rate1	Output	REAL	Current Pulse Rate in user unit per second (Per Pulse method).
Rate2	Output	REAL	Current Pulse Rate in user unit per second (Cyclic method).
TPValue	Output	LINT	Accumulator Value capture when touch probe is triggered.
OutputSts	Output	UINT	HSC plug-in Physical & Virtual Output status and is only applicable for HSC counter 0. Bit 0: Output 0 (Physical Output Status) Bit 1 to 15: Output 1 to Output 15 (Virtual Output Status)
Status	Output	UINT	HSC status information.
Error	Output	BOOL	Indicates an error occurred.
ErrorID	Output	UINT	When an error occurs, ErrorID contains the error code.

### HSCE Function Block Diagram example

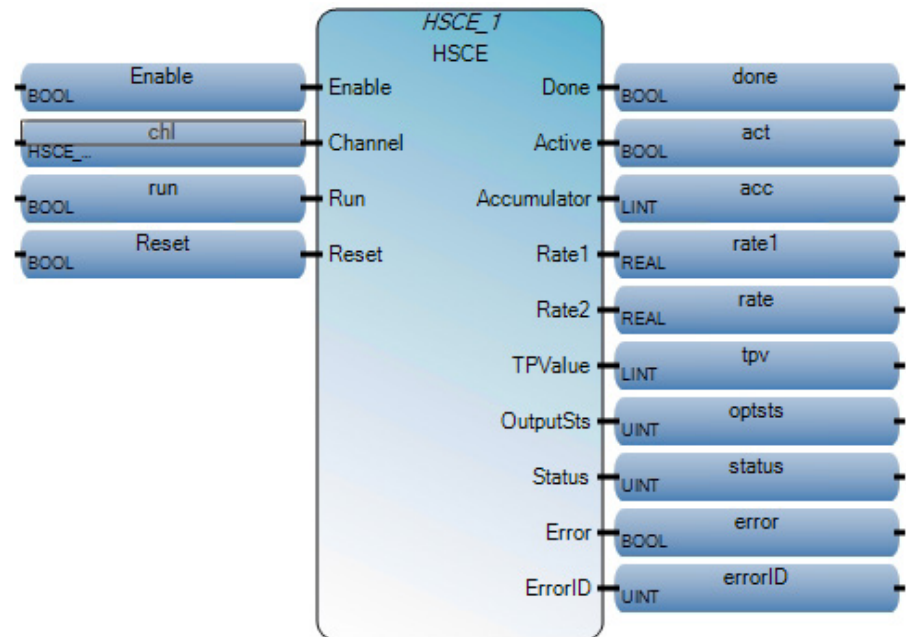



## HSCE Ladder Diagram example

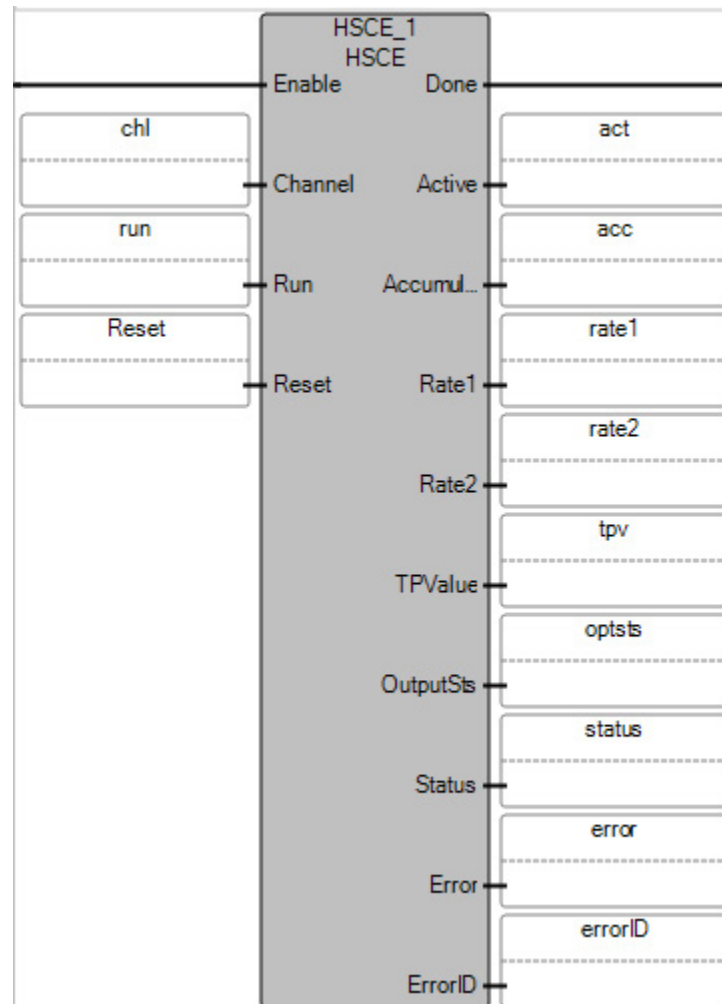

## HSCE Text Structure example

```
HSCE_1();
```

```
void HSCE_1(BOOL Enable, HSCE_CHANNEL Channel, BOOL Run, BOOL Reset)
Type : HSCE, Start, stop and read accumulator value
```

```
1 HSCE_1(Enable, chl, Run, Reset);
2 Done_HSCE := HSCE_1.Done;
3 Active_HSCE := HSCE_1.Active;
4 Accumulator_HSCE := HSCE_1.Accumulator;
5 Rate1_HSCE := HSCE_1.Rate1;
6 Rate2_HSCE := HSCE_1.Rate2;
7 TPValue_HSCE := HSCE_1.TPValue;
8 Outputsts_HSCE := HSCE_1.OutputSts;
9 Status_HSCE := HSCE_1.Status;
10 Error_HSCE := HSCE_1.Error;
11 ErrorID_HSCE := HSCE_1.ErrorID;
```

## HSCE\_CFG

HSCE\_CFG is used to configure high speed counter.

Languages supported: Function Block Diagram, Ladder Diagram, Structured Text.

This instruction applies to the Micro820, Micro830, Micro850, and Micro870 controllers.

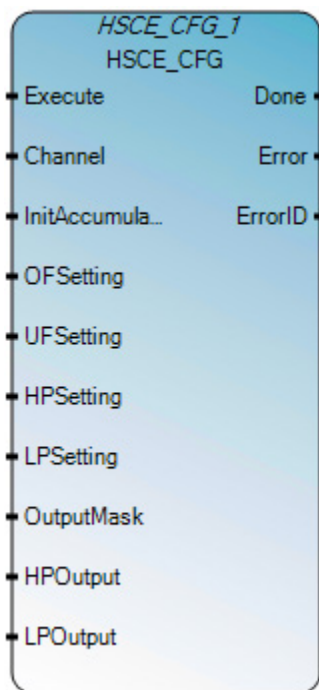

Use this table to help determine the parameter values for this instruction.

Parameter	Parameter Type	Data Type	Description
Execute	Input	BOOL	Rising Edge initiates the HSC configuration. (HSCE Enable should be equal to FALSE) Falling edge will clear all the output value.
Channel	Input	HSCE_CHANNE L	The HSCE channel.
InitAccumulator	Input	LINT	Accumulator initial value.
OFSetting	Input	LINT	Counter overflow limit value.
UFSetting	Input	LINT	Counter underflow limit value.
HPSetting	Input	LINT	High Preset (HP) Value of HSCE.
LPSetting	Input	LINT	Low Preset (LP) Value of HSCE.
PLS_Offset	Input	USINT	Offset to start with in the PLS data array.
OutputMask	Input	USINT	Output mask for PLS functionality.
HPOutput	Input	UDINT	High preset outputs state.
LPOutput	Input	UDINT	Low preset outputs state.
Done	Output	BOOL	HSC configuration action(initiated by this instruction) succeeds.
Error	Output	BOOL	Indicates an error occurred.
ErrorID	Output	UINT	When an error occurs, ErrorID contains the error code.

### HSCE\_CFG Function Block Diagram example

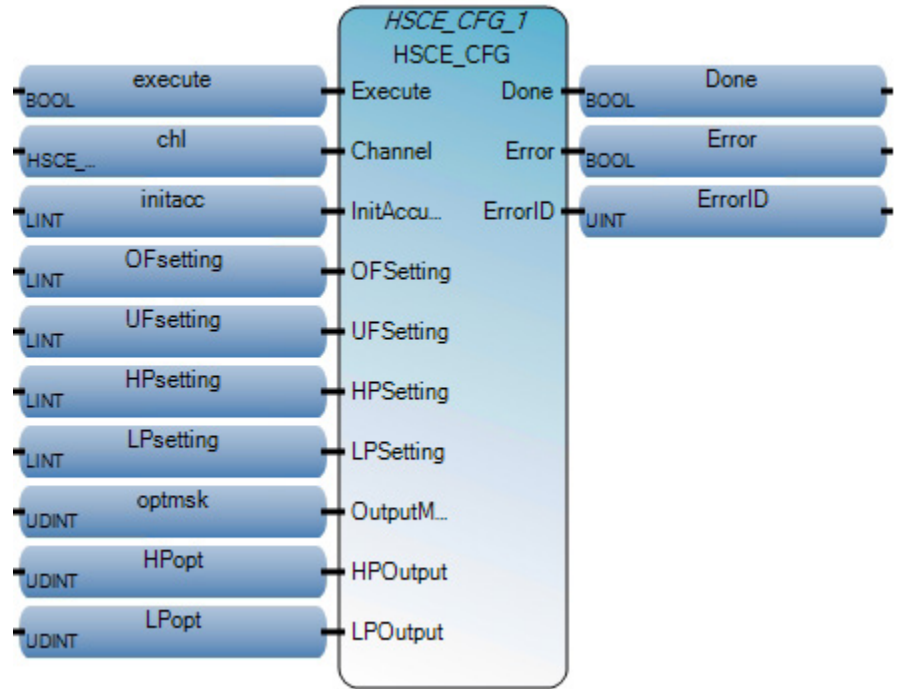

### HSCE\_CFG Ladder Diagram example

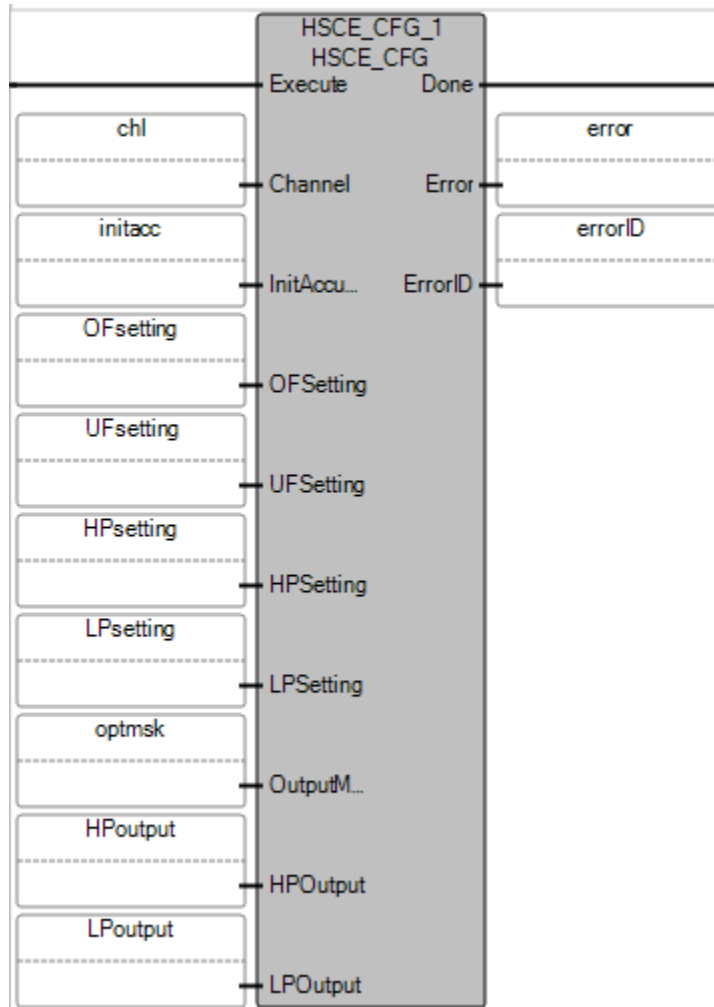

### HSCE\_CFG Text Structure example

```

1 HSCE_CFG_1
void HSCE_CFG_1(BOOL Execute, HSCE_CHANNEL Channel, LINT InitAccumulator, LINT OFSetting, LINT UFSetting, LINT HPSetting, LINT LPSetting, UDINT OutputMask, UDINT HPOutput, UDINT LPOutput)
Type: HSCE_CFG, High Speed Counter configuration

1 HSCE_CFG_1(Execute, chl, initacc, OFsetting, UFsetting, HPsetting, LPsetting, optmsk, HPopt, LPopt);
2 Done_HSCE_CFG := HSCE_CFG_1.Done;
3 Error_HSCE_CFG := HSCE_CFG_1.Error;
4 ErrorID_HSCE_CFG := HSCE_CFG_1.ErrorID;

```

### HSCE\_CFG\_PLS

This instruction is used for HSC configuration with Programmable Limit Switch (PLS). This function is an additional set of operating modes for the High Speed Counter. When operating in these modes, the preset and output data values are updated using user supplied data each time one of the presets is reached. These modes are programmed by providing a PLS file that contains the data sets to be used.

Languages supported: Function Block Diagram, Ladder Diagram, Structured Text.

This instruction applies to the Micro820, Micro830, Micro850, and Micro870 controllers.

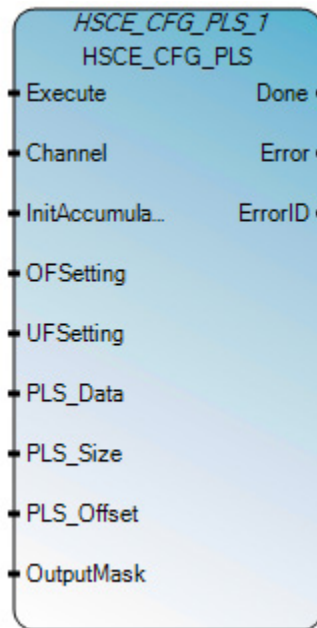

Use this table to help determine the parameter values for this instruction.

Parameter	Parameter Type	Data Type	Description
Execute	Input	BOOL	Rising Edge initiates the HSC configuration. (HSCE Enable should be equal to FALSE) Falling edge will clear all the output value.
Channel	Input	HSCE_CHANNEL	The HSCE channel.
InitAccumulator	Input	LINT	Accumulator initial value.
OFSetting	Input	LINT	Counter overflow limit value.
UFSetting	Input	LINT	Counter underflow limit value.
PLS_Data	Input	PLS2	Array of PLS (PLS_64)
PLS_Size	Input	USINT	PLS data size, and the maximum value is 24 for plug-in.
PLS_Offset	Input	USINT	Offset to start with in the PLS data array.
OutputMask	Input	USINT	Output mask for PLS functionality.
Done	Output	BOOL	HSC configuration action(initiated by this instruction) succeeds.
Error	Output	BOOL	Indicates an error occurred.
ErrorID	Output	UINT	When an error occurs, ErrorID contains the error code.

### HSCE\_CFG\_PLS Function Block Diagram example

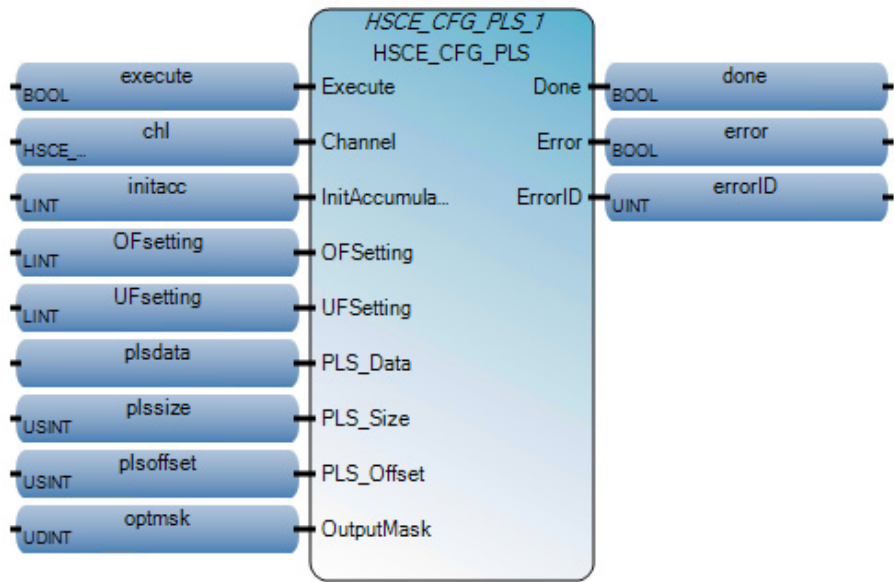

### HSCE\_CFG\_PLS Ladder Diagram example

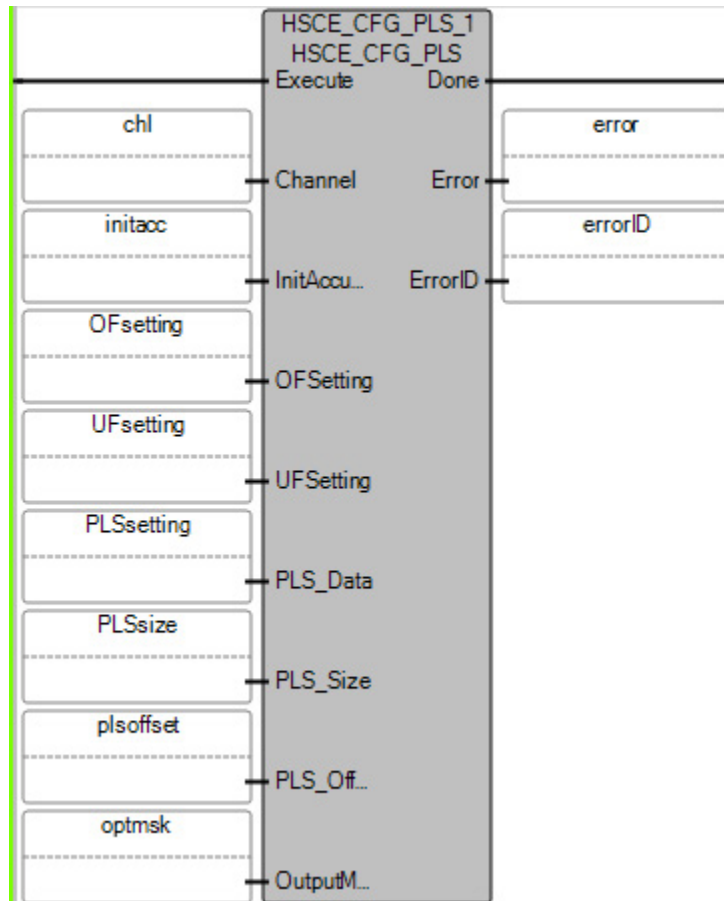

## HSCE\_CFG\_PLS Text Structure example

```

HSCE_CFG_PLS_1
void HSCE_CFG_PLS_1(BOOL Execute, HSCE_CHANNEL Channel, LINT InitAccumulator, LINT OFSetting, LINT UFSetting, PLS_HSCE[1..1] PLS_Data, USINT PLS_Size, USINT PLS_Offset, UDINT OutputMask)
Type: HSCE_CFG_PLS, High Speed Counter PLS configuration
1 HSCE_CFG_PLS_1(Execute, chl, initacc, OFsetting, UFsetting, PLS_data, PLS_Size, PLS_Offset, optmsk);
2 Done_HSCE_CFG_PLS :=HSCE_CFG_PLS_1.Done;
3 Error_HSCE_CFG_PLS :=HSCE_CFG_PLS_1.Error;
4 ErrorID_HSCE_CFG_PLS := HSCE_CFG_PLS_1.ErrorID;
    
```

## HSCE\_READ\_STS

The instruction is used to read current HSC status.

Languages supported: Function Block Diagram, Ladder Diagram, Structured Text.

This instruction applies to the Micro820, Micro830, Micro850, and Micro870 controllers.

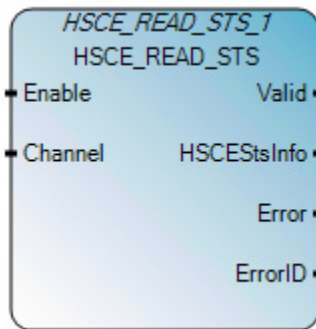

Use this table to help determine the parameter values for this instruction.

Parameter	Parameter Type	Data Type	Description
Enable	Input	BOOL	If Enable is True then HSC2StsInfo is updated.
Channel	Input	HSCE_CHANNEL	The HSC2 channel.
Valid	Output	BOOL	HSC2StsInfo is Valid if TRUE.
HSC2StsInfo	Input	LINT	Counter overflow limit value.
Error	Output	BOOL	Indicates an error occurred.
ErrorID	Output	UINT	When an error occurs, ErrorID contains the error code.

## HSCE\_READ\_STS Function Block Diagram example

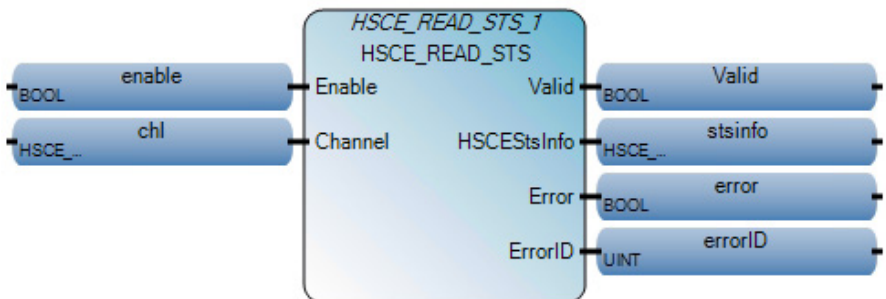

### HSCE\_READ\_STS Ladder Diagram example

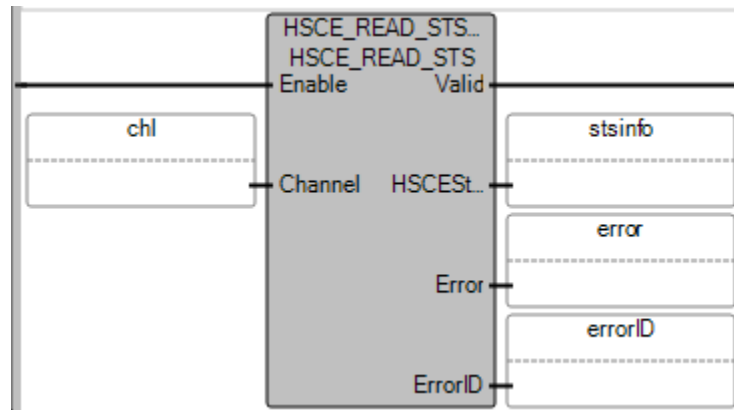

### HSCE\_READ\_STS Text Structure example

```

HSCE_READ_STS_1(
    void HSCE_READ_STS_1(BOOL Enable, HSCE_CHANNEL Channel)
    Type : HSCE_READ_STS, Read High Speed Counter status

1 HSCE_READ_STS_1(Enable, Channel);
2 Valid_HSCE_READ_STS :=HSCE_READ_STS_1.Valid;
3 HSCEstsInfo_HSCE_READ_STS := HSCE_READ_STS_1.HSCEstsInfo;
4 Error_HSCE_READ_STS := HSCE_READ_STS_1.Error;
5 ErrorID HSCE READ STS := HSCE READ STS 1.ErrorID;
    
```

## HSCE\_SET\_STS

The instruction manually sets and resets the HSC counting status flags. The HSC function block must be stopped for the HSCE\_SET\_STC function block to set or reset its HTS status. If the HSC function block is not stopped or HSC channel is not configured, HSC2\_SET\_STS function block will throw error.

Languages supported: Function Block Diagram, Ladder Diagram, Structured Text.



This instruction applies to the Micro820, Micro830, Micro850, and Micro870 controllers.

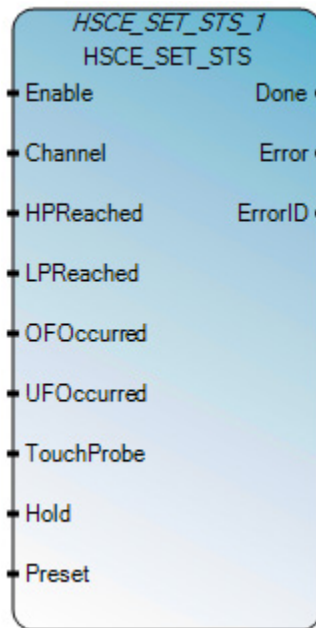

Use this table to help determine the parameter values for this instruction.

Parameter	Parameter Type	Data Type	Description
Enable	Input	BOOL	Function block enable. TRUE - set/reset the HSC status. FALSE - there is no HSC status change.
Channel	Input	HSCE_CHANNEL	The HSCE channel.
HPRReached	Output	BOOL	When High preset value reached, this bit will be set to TRUE by plug-in module. Set or reset this bit by HSCE_SET_STS function block.
LPRReached	Input	BOOL	When low preset value is reached, this bit will be set to be TRUE by plug-in module. Set or reset this bit by HSCE_SET_STS function block.
OFOccurred	Input	BOOL	When overflow occurred, this bit will be set to be TRUE by plug-in module. Set or reset this bit by HSCE_SET_STS function block.
UFOccurred	Input	BOOL	When underflow occurred, this bit will be set to be TRUE by plug-in module. Set or reset this bit by HSCE_SET_STS function block.
TouchProbe	Input	BOOL	When touch probe is triggered, this bit will be set to be TRUE by plug-in module.
Hold	Input	BOOL	When HSC hold is triggered this bit will be set to be TRUE by plugin module. Set or reset this bit by HSCE_SET_STS function block. This input parameter is only effective for counter 0. For counter 1 is always reset
Preset	Input	BOOL	When Z ACC Reset is triggered, this bit will be set to be TRUE by plug-in module. Set or reset this bit by HSCE_SET_STS function block. This input parameter is only effective for counter 0. For counter 1 is always reset.
Done	Output	BOOL	HSC configuration action (initiated by this instruction) succeeds.
Error	Output	BOOL	Indicates an error occurred.
ErrorID	Output	UINT	When an error occurs, ErrorID contains the error code.

### HSCE\_SET\_STS Function Block Diagram example

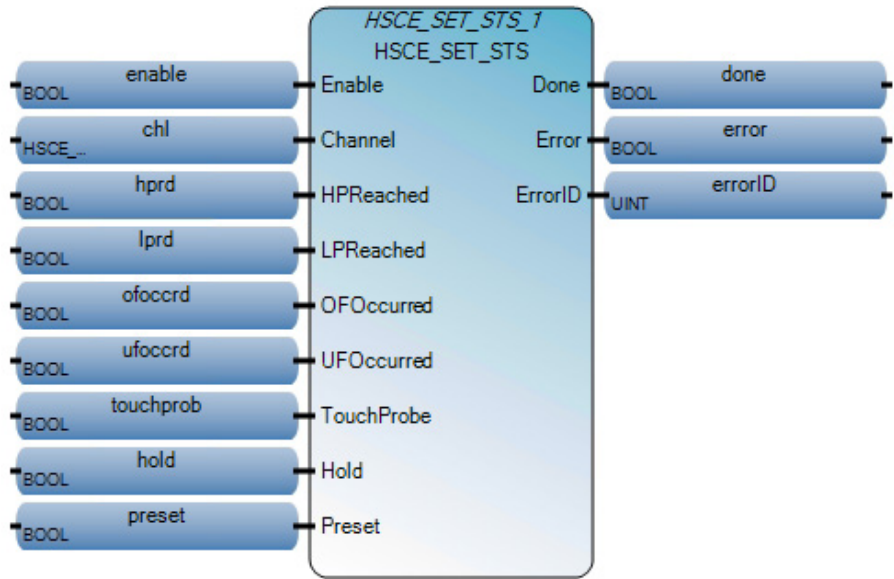

### HSCE\_SET\_STS Ladder Diagram example

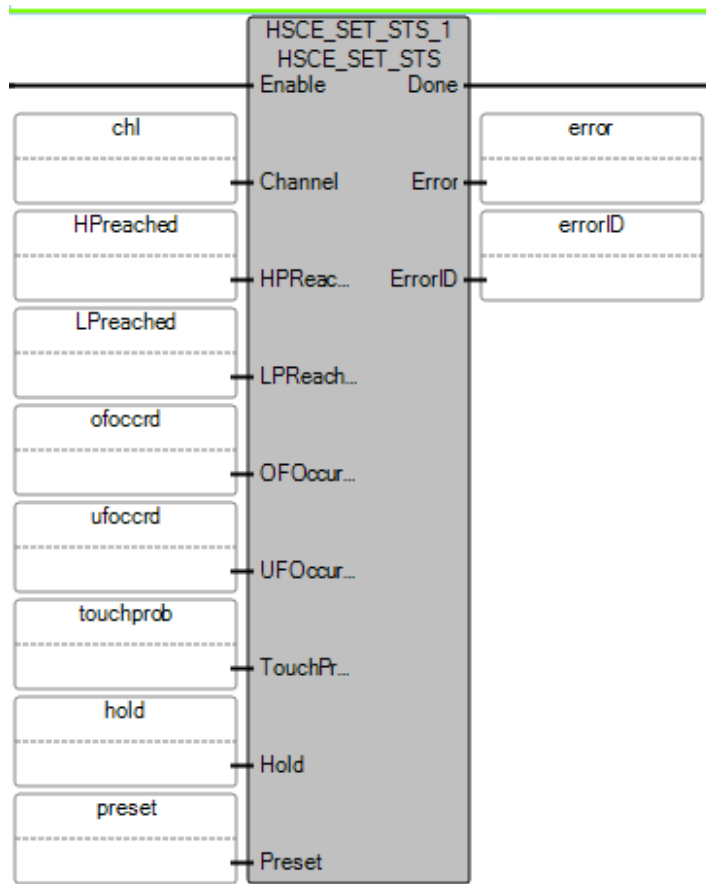

## HSCE\_SET\_STS Text Structure example

```

HSCE_SET_STS_1
void HSCE_SET_STS_1(BOOL Enable, HSCE_CHANNEL Channel, BOOL HPReached, BOOL LPReached, BOOL OFOccurred, BOOL UFOccurred, BOOL TouchProbe, BOOL Hold, BOOL Preset)
Type: HSCE_SET_STS, Manually set/reset High Speed Counter status

1 HSCE_SET_STS_1(Enable, chl, hprd, ofocccrd, ufocccrd, touchprob, hold, preset);
2 Done_HSCE_SET_STS := HSCE_SET_STS_1.Done;
3 Error_HSCE_SET_STS := HSCE_SET_STS_1.Error;
4 ErrorID_HSCE_SET_STS := HSCE_SET_STS_1.ErrorID;

```

## HSCE error codes

The following table describes the status error codes for [HSCE instructions](#) on [page 327](#):

ErrorID Code	Error description	Corrective action
0	The instruction successfully completed operation.	
1	Invalid HSC configuration files.	Contact the Rockwell Automation technical support representative. For contact information, see: <a href="http://www.rockwellautomation.com/support">http://www.rockwellautomation.com/support</a>
2	Invalid HSC module type.	Correct the module type. For example, select module type as plug-in.
3	Invalid HSC Slot ID.	Correct the Slot ID in the Channel input of the function block.
4	Invalid HSC ID.	Correct the HSC ID. For example, set 0 for counter 0.
5	Invalid mode for the Channel.	Contact Rockwell Automation technical support representative.
6	Invalid PLS Size.	PLS size should be $\leq 24$ and size of the PLS data array $\geq$ PLS size.
7	Invalid PLS offset.	PLS offset + PLS size should be within the size of the PLS data array.
8	Invalid InitAccumulator value.	Correct the InitAccumulator value. Maybe it is over the boundary or out range of LP or HP limit ( $LP \leq \text{InitACC} \leq HP$ ).
9	Invalid LP.	Correct the LP value. It may be over the boundary.
10	Invalid OF.	Correct the OF value.
11	Invalid UF.	Correct the UF value.
12	Invalid HP.	Correct the HP value.
13	There is no configuration for HSCE.	Contact the Rockwell Automation technical support representative.
14	Invalid HSCE state.	Check the HSCE related function block to confirm the state of this function block.
15	Invalid plug-in module	Check the plug-in module to confirm it is HSC module.
16	HSCE is running.	When HSC is counting, no configuration and setting status are allowed. <a href="#">HSCE_CFG</a> on <a href="#">page 330</a> and <a href="#">HSCE_CFG_PLS</a> on <a href="#">page 332</a> are executed while HSCE is running.
17	Stop HSC plug-in failure.	Contact the Rockwell Automation technical support representative.
18	Update rate write failure.	Contact the Rockwell Automation technical support representative.
19	Write the number of plus failure.	Contact the Rockwell Automation technical support representative.
20	Write Apply ACC failure.	Contact the Rockwell Automation technical support representative.
21	Write ACC failure.	Contact the Rockwell Automation technical support representative.
22	Write Apply failure.	Contact the Rockwell Automation technical support representative.
23	Write number of PLS failure.	Contact the Rockwell Automation technical support representative.
24	Write under flow failure.	Contact the Rockwell Automation technical support representative.
25	Write over flow failure.	Contact the Rockwell Automation technical support representative.
26	Write low preset failure.	Contact the Rockwell Automation technical support representative.
27	Write high preset failure.	Contact the Rockwell Automation technical support representative.
28	Write low preset out failure.	Contact the Rockwell Automation technical support representative.
29	Write high preset out failure.	Contact the Rockwell Automation technical support representative.
30	Write out mask failure.	Contact the Rockwell Automation technical support representative.
31	Write PLS low preset out failure.	Contact the Rockwell Automation technical support representative.
32	Write PLS high preset out failure.	Contact the Rockwell Automation technical support representative.

**Chapter 15 HSCE instructions**

<b>ErrorID Code</b>	<b>Error description</b>	<b>Corrective action</b>
33	Write PLS low preset failure.	Contact the Rockwell Automation technical support representative.
34	Write PLS high preset out failure.	Contact the Rockwell Automation technical support representative.
35	Write PLS offset failure.	Contact the Rockwell Automation technical support representative.
36	Write PLS number failure.	Contact the Rockwell Automation technical support representative.
37	Read status failure.	Contact the Rockwell Automation technical support representative.
38	Read high preset failure.	Contact the Rockwell Automation technical support representative.
39	Read low preset failure.	Contact the Rockwell Automation technical support representative.
40	Read ACC failure.	Contact the Rockwell Automation technical support representative.
41	Read number of pulse width failure.	Contact the Rockwell Automation technical support representative.
42	Read pulse width failure.	Contact the Rockwell Automation technical support representative.
43	Read number of pulse failure.	Contact the Rockwell Automation technical support representative.
44	Read update rate failure.	Contact the Rockwell Automation technical support representative.
45	Write status failure.	Contact the Rockwell Automation technical support representative.
46	Read low preset out failure.	Contact the Rockwell Automation technical support representative.
47	Read high preset out failure.	Contact the Rockwell Automation technical support representative.
48	Read PLS number failure.	Contact the Rockwell Automation technical support representative.
49	N.A.	Contact the Rockwell Automation technical support representative.
50	Write apply status failure.	Contact the Rockwell Automation technical support representative.
51	Invalid channel input.	Contact the Rockwell Automation technical support representative.
52	Read touch probe failure.	Contact the Rockwell Automation technical support representative.
53	Write reset ACC failure.	Contact the Rockwell Automation technical support representative.
54	Start HSC failure.	Contact the Rockwell Automation technical support representative.
55	Counter is disabled.	The HSC counter is disabled. Check the Channel configuration to verify if the HSC counter is enabled.
56	Invalid output mask value.	Check if the output mask is within the valid range. For plug-in HSC module, the range is 0-65535.
57	Invalid high preset output.	Check the if the HP output is within the valid range. For plug-in HSC module, the range is 0-65535.
58	Invalid low preset output.	Check if the LP output is within the valid range. For plug-in HSC module, the range is 0-65535.
59	Not a supported UPM revision.	Check the revision configuration for the HSC plug-in module.
60	Not a HSC module is added.	Check if the actual plug-in module is HSC module.
61	HSCE plug-in module is not configured.	Contact the Rockwell Automation technical support representative.
62	A UPM plug-in Write error occurs while changing HSC plug-in Mode to Non-run.	Contact the Rockwell Automation technical support representative.
63	A UPM plug-in Write error occurs while changing HSC plug-in Mode to run mode.	Contact the Rockwell Automation technical support representative.
64	A UPM plug-in Read error occurs while reading Output Status.	Contact the Rockwell Automation technical support representative.

## Input/Output instructions

Use Input/Output instructions to read or write data to or from a controller or module using signals sent to a device that is physically connected to a programmable logic controller. Input relays transfer signals to the internal relays, and output relays transfer signals to external output devices.

Instruction	Description
<a href="#">LCD</a> on <a href="#">page 341</a>	Micro810 only. Displays a string or number on an LCD screen.
<a href="#">LCD_BKLT_REM</a> on <a href="#">page 344</a>	Sets the remote LCD backlight parameters in a user program.
<a href="#">LCD_REM</a> on <a href="#">page 346</a>	Displays user defined messages for the remote LCD.
<a href="#">RHC</a> on <a href="#">page 348</a>	Reads the high speed clock value in the Micro800 controller.
<a href="#">RPC</a> on <a href="#">page 350</a>	Reads the user program checksum, either from the controller or memory module.
<a href="#">DLG</a> on <a href="#">page 351</a>	Writes variable values from the run-time engine into a Data Logging File on an SD Card.
<a href="#">IIM</a> on <a href="#">page 353</a>	Updates inputs prior to normal output scan.
<a href="#">IOM</a> on <a href="#">page 354</a>	Updates outputs prior to normal output scan.
<a href="#">KEY_READ</a> on <a href="#">page 356</a>	Micro810 only. Reads the Key status on the optional LCD module when the user display is active.
<a href="#">KEY_READ_REM</a> on <a href="#">page 359</a>	Micro820 only. Reads the Key status on the optional remote LCD module when the user display is active.
<a href="#">MM_INFO</a> on <a href="#">page 361</a>	Reads memory module header information.
<a href="#">MODULE_INFO</a> on <a href="#">page 364</a>	Reads module information from a plug-in or expansion module excluding the 2080-MEMBAK-RTC memory module.
<a href="#">PLUGIN_INFO</a> on <a href="#">page 375</a>	Reads module information from a generic plug-in or expansion module excluding the 2080-MEMBAK-RTC memory module.
<a href="#">PLUGIN_READ</a> on <a href="#">page 377</a>	Reads data from a generic plug-in module excluding the 2080-MEMBAK-RTC memory module.
<a href="#">PLUGIN_RESET</a> on <a href="#">page 379</a>	Resets the hardware for a generic plug-in module excluding the 2080-MEMBAK-RTC memory module.
<a href="#">PLUGIN_WRITE</a> on <a href="#">page 381</a>	Writes data to a generic plug-in module excluding the 2080-MEMBAK-RTC memory module.
<a href="#">RCP</a> on <a href="#">page 383</a>	Reads and writes recipe data to and from an SD memory card.
<a href="#">RTC_READ</a> on <a href="#">page 385</a>	Reads the real-time clock (RTC) module information.
<a href="#">RTC_SET</a> on <a href="#">page 387</a>	Sets RTC data to the RTC module information.
<a href="#">SYS_INFO</a> on <a href="#">page 389</a>	Reads the status data block for the Micro800 controller.
<a href="#">TRIMPOT_READ</a> on <a href="#">page 392</a>	Reads the trimpot value from a specific trimpot.

### LCD

Displays a string or a number on the optional LCD screen.

Languages supported: Function Block Diagram, Ladder Diagram, Structured Text.

This instruction applies to the Micro810 controllers.

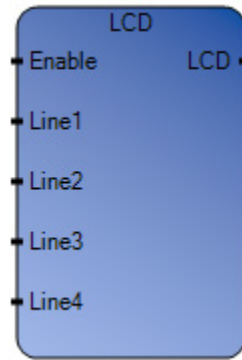

Use this table to help determine the parameter values for this instruction.

Parameter	Parameter Type	Data Type	Description
Enable	Input	BOOL	Instruction enable. TRUE - the LCD switches to the user-defined screen (strings display on the LCD screen) instead of the I/O status screen. FALSE - the LCD displays the contents of the I/O status screen.
Line1	Input	STRING	String displayed on line 1 of the LCD.
Line2	Input	STRING	String displayed on line 2 of the LCD.
Line3	Input	STRING	String displayed on line 3 of the LCD.
Line4	Input	STRING	String displayed on line 4 of the LCD.
LCD	Output	BOOL	TRUE - function is enabled.

### LCD Function Block Diagram example

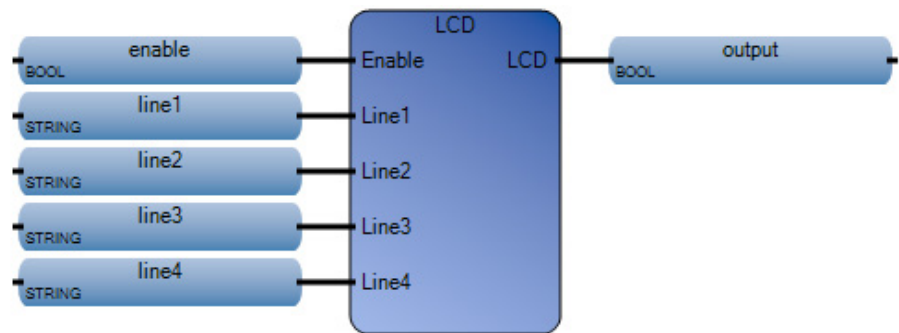

## LCD Ladder Diagram example

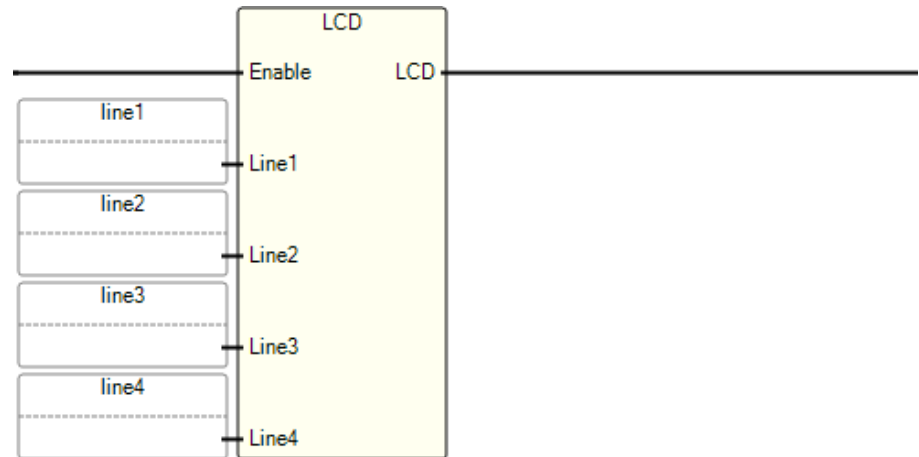

## LCD Structured Text example

**LCD** (  
 BOOL **LCD**(BOOL Enable, STRING Line1, STRING Line2, STRING Line3, STRING Line4)  
 Display string or number according to user requirements if option LCD mounts.

```

1 enable := TRUE;
2 line1 := 'R';
3 line2 := 'O';
4 line3 := 'C';
5 line4 := 'K';
6 output := LCD(enable, line1, line2, line3, line4);

```

(\* ST Equivalence: \*)

```
TESTOUTPUT := LCD(LCDENABLE, LINE1, LINE2, LINE3, LINE4);
```

## Results

Name	Logical Value	Physical Value	Lock	Data Type
enable	<input checked="" type="checkbox"/>	N/A	<input type="checkbox"/>	BOOL
line1	R	N/A	<input type="checkbox"/>	STRING
line2	O	N/A	<input type="checkbox"/>	STRING
line3	C	N/A	<input type="checkbox"/>	STRING
line4	K	N/A	<input type="checkbox"/>	STRING
output	<input checked="" type="checkbox"/>	N/A	<input type="checkbox"/>	BOOL

## LCD\_BKLT\_REM (remote LCD backlight)

Sets the Remote LCD backlight parameters in a user program.

Operation details:

The backlight settings defined in LCD\_BKLT\_REM are used when the Remote LCD display is:

- a user defined screen defined using LCD\_REM.
- the default IO Status screen.
- For all other screens, the backlight settings used are those defined using the menu on the Remote LCD.

Languages supported: Function Block Diagram, Ladder Diagram, Structured Text.

This instruction applies to the Micro820 controllers.

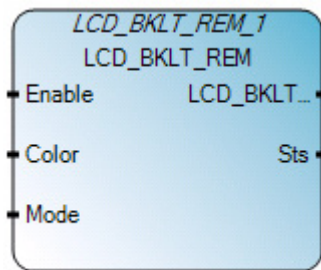

Use this table to help determine the parameter values for this instruction.

Parameter	Parameter Type	Data Type	Description
Enable	Input	BOOL	Instruction enable. TRUE - execute REM_LCD_BKLT, overwrite any current backlight settings. FALSE - REM_LCD_BKLT is disabled and the Remote LCD menu settings take effect.
Color	Input	UINT	Backlight Color Code <ul style="list-style-type: none"> <li>• 0: White</li> <li>• 1: Blue</li> <li>• 2: Red</li> <li>• 3: Green</li> <li>• 4-65535: Reserved</li> </ul>
Mode	Input	UINT	<ul style="list-style-type: none"> <li>• 0 : Permanently OFF</li> <li>• 1: Permanently ON</li> <li>• 2: Flash (1 sec interval)</li> <li>• 3-65535: Reserved</li> </ul>
LCD_BKLT_REM	Output	BOOL	TRUE - Instruction executed successfully. FALSE - Error occurred during instruction execution.



Sts	Output	UINT	<p>Status of the remote LCD operation.</p> <p>LCD_BKLT_REM status codes:</p> <ul style="list-style-type: none"> <li>• 0 - Enable input is false.</li> <li>• 1 - Success.</li> <li>• 2 - Remote LCD not detected.</li> </ul> <p>May occur when:</p> <ul style="list-style-type: none"> <li>• Remote LCD is not physically connected to the controller or the wiring is incorrect.</li> <li>• Serial port settings are other than what is required for the Remote LCD.</li> </ul> <ul style="list-style-type: none"> <li>• 3 - Connection error.</li> </ul> <p>May occur when there is an internal state machine error such as an incompatibility between Controller FW version and RLCD FW version.</p> <ul style="list-style-type: none"> <li>• 4 - Invalid color code.</li> <li>• 5 - Invalid mode.</li> <li>• 6-65535 - Reserved.</li> </ul>
-----	--------	------	--

### LCD\_BKLT\_REM Function Block Diagram examples

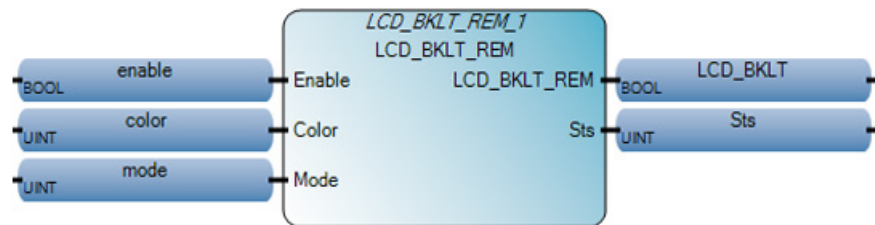

### LCD\_BKLT\_REM Ladder Diagram example

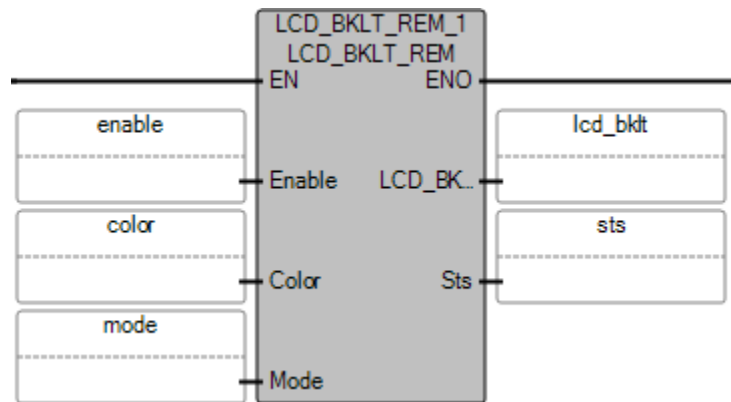

### LCD\_BKLT\_REM Structured Text example

```

LCD_BKLT_REM_4 (
    void LCD_BKLT_REM_4(BOOL Enable, UINT Color, UINT Mode)
    Type: LCD_BKLT_REM, Set the remote LCD backlight parameters.

1 | LCD_BKLT_REM_1 (EN, Enable, Color, Mode);
2 | output := LCD_BKLT_REM_1.ENO
3 | LCD_BKLT_REM_1 := LCD_BKLT_REM_1.LCD_BKLT_REM
4 | sts_lcd_rem := LCD_REM_1.Sts
    
```

## LCD\_REM (remote LCD)

Displays user defined messages for the Remote LCD.

Operation details:

- For Line1 through Line8 the maximum string length is 24 characters.

Languages supported: Function Block Diagram, Ladder Diagram, Structured Text.

This instruction applies to the Micro820 controllers.

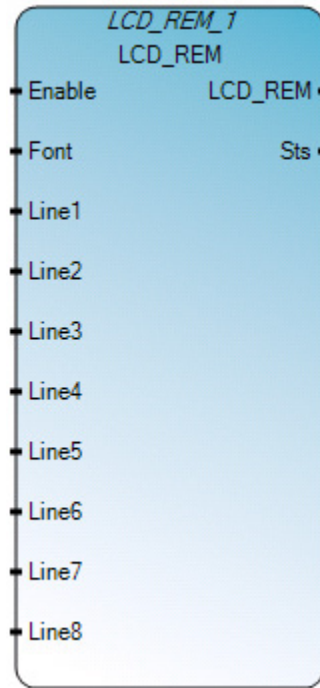

Use this table to help determine the parameter values for this instruction.

Parameter	Parameter Type	Data Type	Description
Enable	Input	BOOL	Enable the instruction block. TRUE - remote LCD switches to user-defined screen from I/O status screen. FALSE - remote LCD switches back to I/O status screen.
Font	Input	UDINT	Font size for startup message: <ul style="list-style-type: none"> <li>• 0: Default (Large - 8x16)</li> <li>• 1: Small (8x8)</li> <li>• 2: Large (8x16)</li> <li>• 3: Extra Large (16x16)</li> <li>• 4 onward: Reserved</li> </ul> The Remote LCD size is 192x64 pixels. When the font size for the start up message is small font, the Remote LCD displays: <ul style="list-style-type: none"> <li>• strings in Line1 to Line8.</li> <li>• a maximum of 24 characters per line.</li> </ul> When the font size for the start up message is large or extra large, the Remote LCD displays: <ul style="list-style-type: none"> <li>• strings in Line1 to Line4.</li> <li>• ignores strings in Line5 to Line8.</li> <li>• a maximum of 12 characters per line.</li> </ul>

Line1	Input	String	String to be displayed on line 1 of the LCD. For Line1 through Line8 the maximum string length is 24 characters.
Line2	Input	String	String displayed on line 2 of the LCD.
Line3	Input	String	String displayed on line 3 of the LCD.
Line4	Input	String	String displayed on line 4 of the LCD.
Line5	Input	String	String displayed on line 5 of the LCD.
Line6	Input	String	String displayed on line 6 of the LCD.
Line7	Input	String	String displayed on line 7 of the LCD.
Line8	Input	String	String displayed on line 8 of the LCD.
LCD_REM	Output	BOOL	Function block enable. When Enable = TRUE, user display is active. When Enable = FALSE, IO Status/Menu display is active.
Sts	Output	UINT	Status of the remote LCD operation. LCD_REM status codes: <ul style="list-style-type: none"> <li>• 0 - Enable input is false.</li> <li>• 1 - User message displayed successfully.</li> <li>• 2 - Remote LCD not detected.</li> <li>• 3 - Connection error.</li> </ul> May occur when: <ul style="list-style-type: none"> <li>• Remote LCD is not physically connected to the controller (or the wiring is incorrect).</li> <li>• Serial port settings are other than what is required for the Remote LCD.</li> </ul> <ul style="list-style-type: none"> <li>• 4 - Invalid font code.</li> <li>• 5 - 5-65535 - Reserved.</li> </ul>

### LCD\_REM Function Block Diagram example

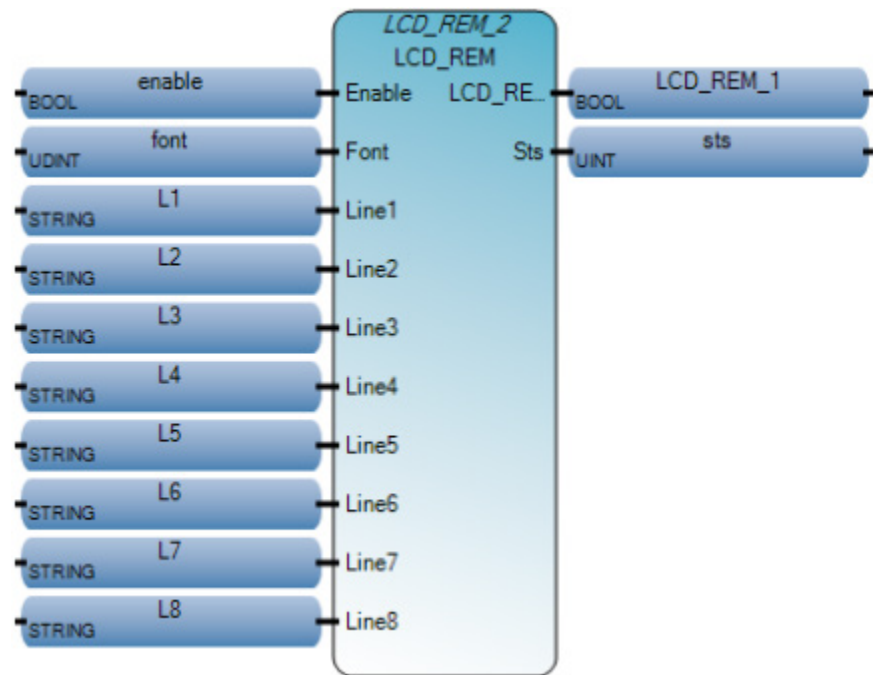

### LCD\_REM Ladder Diagram example

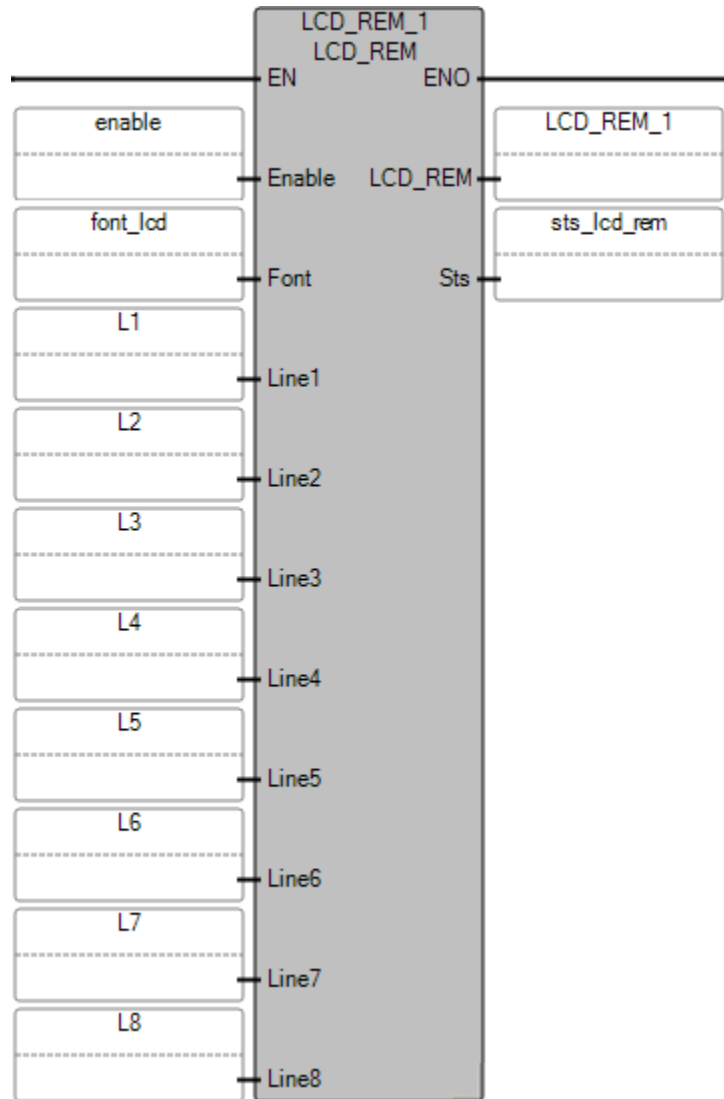

### LCD\_REM Structured Text example

```

LCD_REM_1
void LCD_REM_1(BOOL Enable, UDINT Font, STRING Line1, STRING Line2, STRING Line3, STRING Line4, STRING Line5, STRING Line6, STRING Line7, STRING Line8)
Type: LCD_REM, Display user strings on remote LCD when it is connected.

1| LCD_REM_1 (EN, Enable, Font, Line1, Line2, Line3, Line4, Line5, Line6, Line7, Line8);
2| output := LCD_REM_1.ENO
3| LCD_REM_1 := LCD_REM_1.LCD_REM
4| sts_lcd_rem := LCD_REM_1.Sts
    
```

**RHC (read high speed clock)** Reads the high speed clock value in the Micro800 controller.

Languages supported: Function Block Diagram, Ladder Diagram, Structured Text.

This instruction applies to the Micro810, Micro820, Micro830, Micro850, Micro870 controllers and Micro800 Simulator.



Use this table to help determine the parameter values for this instruction.

Parameter	Parameter Type	Data Type	Description
EN	Input	BOOL	Instruction enable. TRUE - read high speed clock. FALSE - no operation. Applies to Ladder Diagram programs.
ENO	Output	BOOL	Enable output. Applies to Ladder Diagram programs.
RHC	Output	UDINT	The value of the high speed clock.

### High-speed clock resolution

Controller Type	Increments	Timebase	Resolution
Micro810	4 every 40 microseconds	10 microseconds	40 microseconds
Micro820 Micro830 Micro850	1 every 10 microseconds	10 microseconds	10 microseconds

### RHS Function Block Diagram example



### RHS Ladder Diagram example

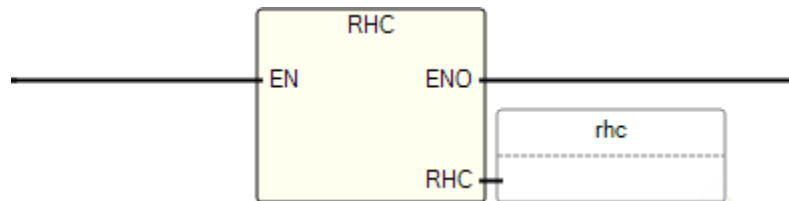

### RHS Structured Text example

```
RHC (|
  UDINT RHC()
  Read high-speed clock.
```

```
1 | rhc := RHC ();
```

(\* ST Equivalence: \*)

```
TESTOUTPUT2 := RHC();
```

### RPC (read program checksum)

Reads the user program checksum, either from the controller or memory module.

Languages supported: Function Block Diagram, Ladder Diagram, Structured Text.

This instruction applies to the Micro810, Micro820, Micro830, Micro850, Micro870 controllers and Micro800 Simulator.



Use this table to help determine the parameter values for this instruction.

Parameter	Parameter Type	Data Type	Description
MemMod	Input	BOOL	TRUE - the value is taken from the memory module. FALSE - the value is taken from the Micro800 controller.
ENO	Output	BOOL	Enable output. Applies to Ladder Diagram programs.
RPC	Output	UDINT	The checksum value of the specified user program.

### RPC Function Block Diagram example

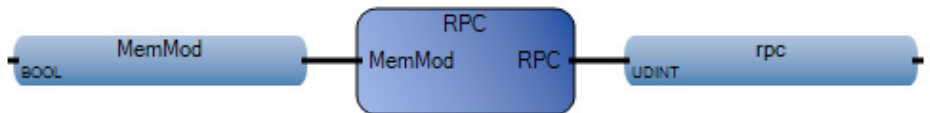

### RPC Ladder Diagram example

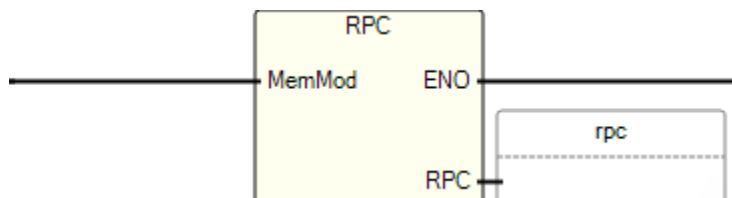

## RPC Structured Text example

```
RPC (
  UDINT RPC(BOOL MemMod)
  Reads user program checksum.
```

```
1 MemMod := TRUE;
2 rpc := RPC(MemMod);
```

(\* ST Equivalence: \*)

```
TESTOUTPUT2 := RPC(TESTINPUT);
```

## DLG (data log)

Writes variable values from the run-time engine into a Data Logging File on an SD Card.

When writing to a data log a maximum of 50 group folders are allowed per day. Each group folder has a maximum of 50 files with a file size of 4k-8k.

Languages supported: Function Block Diagram, Ladder Diagram, Structured Text.

This instruction applies to the Micro820, Micro830, Micro850, and Micro870 controllers.

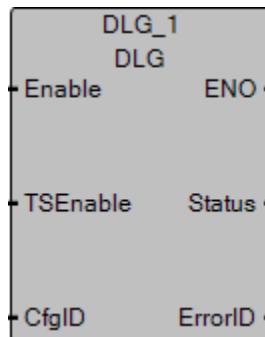

Use this table to help determine the parameter values for this instruction.

Parameter	Parameter Type	Data Type	Description
Enable	Input	BOOL	Data logging write enable. TRUE - Rising Edge Enable detected, start data logging operation when previous instruction operations are complete. FALSE - Rising Edge not detected.
TSEnable	Input	BOOL	TRUE - Date and time stamp logging enable flag.
CfgID	Input	USINT	Data logging configuration VA ID number from 1-10.
ENO	Output	BOOL	Enable output. Applies to Ladder Diagram programs.
Status	Output	USINT	Current status of the instruction. Data logging Status codes: <ul style="list-style-type: none"> <li>• 0 - Idle</li> <li>• 1 - Doing</li> <li>• 2 - Succeed, indicates data logging is complete.</li> <li>• 3 - Error, indicates data logging completed with error.</li> </ul>

ErrorID	Output	UDINT	A unique numeric error code for DLG.
---------	--------	-------	--------------------------------------

### DLG error codes

Error code	Error Name	Comments
0	DLG_ERR_NONE	No error.
1	DLG_ERR_NO_SDCARD	SD card is absent.
2	DLG_ERR_RESERVED	Reserved.
3	DLG_ERR_DATAFILE_ACCESS	Access Data logging file error.
4	DLG_ERR_CFG_ABSENT	Data logging configuration file is absent.
5	DLG_ERR_CFG_ID	Configure ID is absent in data logging configuration file
6	DLG_ERR_RESOURCE_BUSY	The Data logging operation linked to this Data logging ID is used by another FB operation.
7	DLG_ERR_CFG_FORMAT	Data logging configuration file format is invalid.
8	DLG_ERR_RTC	Real time clock is invalid.
9	DLG_ERR_UNKNOWN	Unspecified error has occurred.

### DLG Function Block Diagram example

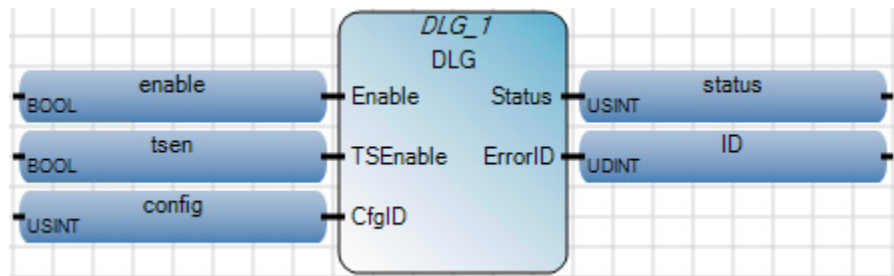

### DLG Ladder Diagram example

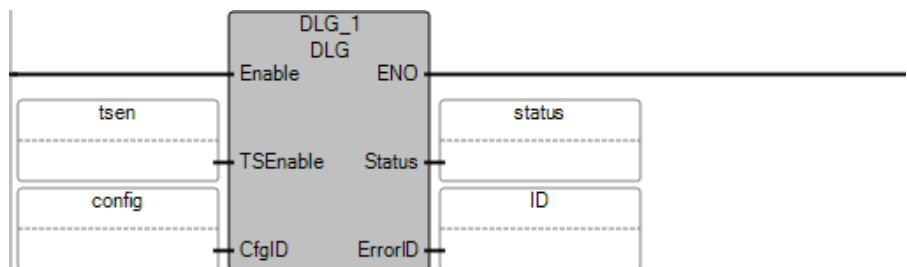

### DLG Structured Text example

```

DLG_1 (
    void DLG_1(BOOL Enable, BOOL TSEnable, USINT CfgID)
    Type : DLG, Save list of data instances to SD Card Data Log file.

1 | DLG_1 (EN, Enable, TSEnable, CfgID)
2 | output := DLG_1.ENO
3 | status := DLG_1.Status
4 | ID := DLG_1.ErrorID
    
```



**IIM (immediate input)**

Update inputs prior to normal output scan.

Operation details:

- Typically used at the beginning of an interrupt program to select or mask inputs that are immediately scanned to get the current inputs.

Languages supported: Function Block Diagram, Ladder Diagram, Structured Text.

This instructions applies to the Micro830, Micro850, and Micro870 controllers.

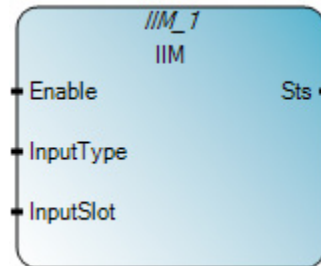

Use this table to help determine the parameter values for this instruction.

Parameter	Parameter Type	Data Type	Description
Enable	Input	BOOL	Instruction block enable. TRUE - execute instruction block. FALSE - do not execute.
InputType	Input	USINT	Identifies the type of input: 0 - Embedded input. 1 - Plug-in input.
InputSlot	Input	USINT	Identifies the input slot. 0 - Embedded input 1,2,3,4,5 - Plug-in slot number. (Slots are numbered from left to right, starting with number 1.) For embedded input, always 0. For Plug-in input, input slot is 1,2,3,4,5 (Plug-in slot number, starting with left-most slot = 1).
Sts	Output	USINT	Immediate input scan status. IIM status (Sts) codes: <ul style="list-style-type: none"> <li>• 0x00 - Not enabled (no action taken).</li> <li>• 0x01 - Input/output scan success.</li> <li>• 0x02 - Input/output type invalid.</li> <li>• 0x03 - Input/output slot invalid.</li> </ul>
ENO	Output	BOOL	Enable output. TRUE - Input updated. FALSE - Input not updated. Applies only to Ladder Diagram programs.

### IIM Function Block Diagram example

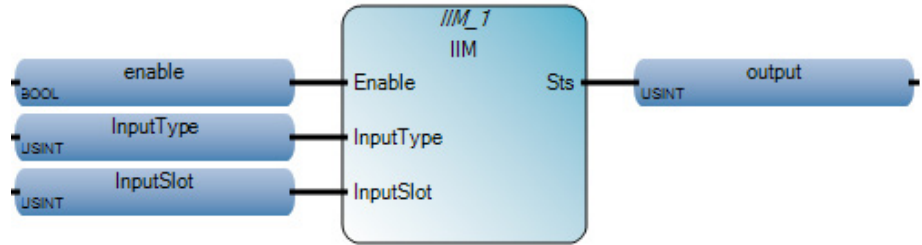

### IIM Ladder Diagram example

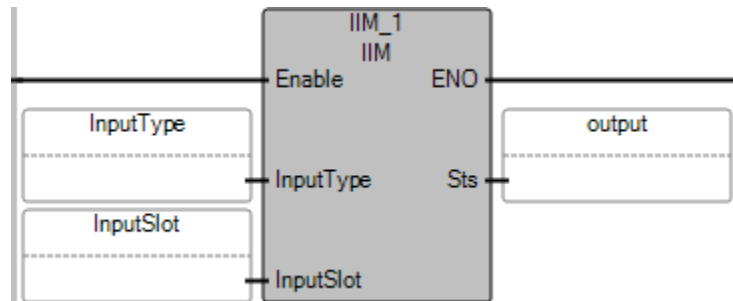

### IIM Structured Text example

```

IIM_1 (
void IIM_1(BOOL Enable, USINT InputType, USINT InputSlot)
Type : IIM, Update inputs prior to normal input scan.

1 enable := TRUE;
2 InputType := 0;
3 InputSlot := 0;
4 IIM_1(enable, InputType, InputSlot);
5 output := IIM_1.Sts;

```

### Results

Variable Monitoring

Name	Logical Value	Physical Value	Initial Value	Lock	Data Type
IIM_1	...	...	...	<input type="checkbox"/>	IIM
InputSlot	0	N/A		<input type="checkbox"/>	USINT
InputType	0	N/A		<input type="checkbox"/>	USINT
output	1	N/A		<input type="checkbox"/>	USINT

### IOM (immediate output)

Update outputs prior to normal output scan.

Operation details:

- Typically used at the end of an interrupt program to select or mask which outputs are immediately scanned and updated.

Languages supported: Function Block Diagram, Ladder Diagram, Structured Text.

This instructions applies to the Micro830, Micro850, and Micro870 controllers.

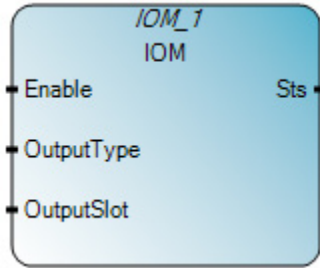

Use this table to help determine the parameter values for this instruction.

Parameter	Parameter Type	Data Type	Description
Enable	Input	BOOL	Instruction block enable. TRUE - execute instruction. FALSE - do not execute.
OutputType	Input	USINT	Identifies the type of output: 0 - Embedded output. 1 - Plug-in output.
OutputSlot	Input	USINT	Identifies the output slot: 0 - Embedded output 1,2,3,4,5 - Plug-in slot number. (Slots are numbered from left to right, starting with number 1.) For embedded output, always 0. For Plug-in output, output slot is 1,2,3,4,5 (Plug-in slot number, starting with left-most slot = 1).
Sts	Output	USINT	Immediate output scan status. IOM (Sts) status codes: <ul style="list-style-type: none"> <li>• 0x00 - Not enabled (no action taken).</li> <li>• 0x01 - Input/output scan success.</li> <li>• 0x02 - Input/output type invalid.</li> <li>• 0x03 - Input/output slot invalid.</li> </ul>
ENO	Output	BOOL	Enable output. TRUE - Output updated. FALSE - Output not updated. Applies only to Ladder Diagram programs.

### IOM Function Block Diagram example

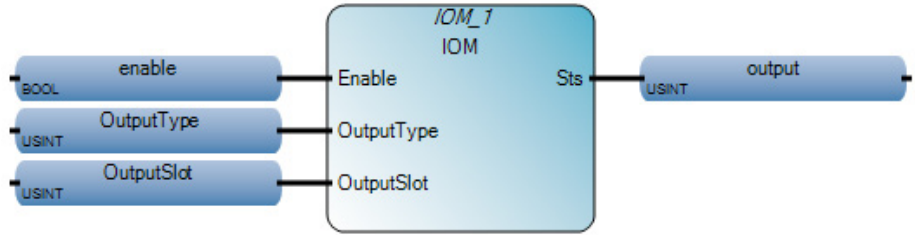

### IOM Ladder Diagram example

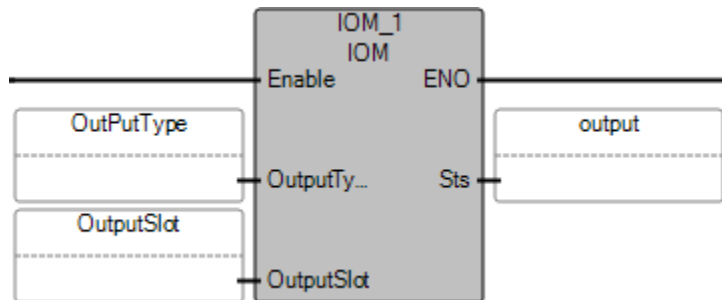

### IOM Structured Text example

```
IOM_1(
void IOM_1(BOOL Enable, USINT OutputType, USINT OutputSlot)
Type : IOM, Update outputs prior to normal output scan.
```

```
1 enable := TRUE;
2 OutputType := 0;
3 OutputSlot := 0;
4 IOM_1(enable, OutputType, OutputSlot);
5 output := IOM_1.Sts;
```

### Results

Name	Logical Value	Physical Value	Initial Value	Lock	Data Type
OutputType	0	N/A		<input type="checkbox"/>	USINT
OutputSlot	0	N/A		<input type="checkbox"/>	USINT
output	1	N/A		<input type="checkbox"/>	USINT
IOM_1	...	...	...	<input type="checkbox"/>	IOM
enable	<input checked="" type="checkbox"/>	N/A		<input type="checkbox"/>	BOOL

### KEY\_READ (read keys on LCD)

Reads the Key status on the optional LCD module when the user display is active.

Languages supported: Function Block Diagram, Ladder Diagram, Structured Text.

This instruction applies to the Micro810 controller.

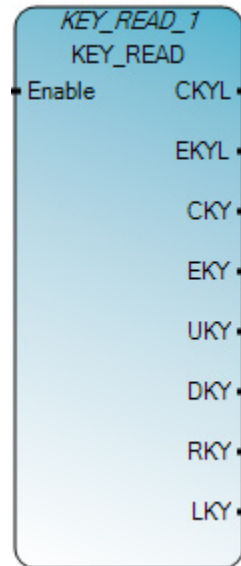

Use this table to help determine the parameter values for this instruction.

Parameter	Parameter Type	Data Type	Description
Enable	Input	BOOL	Enables the instruction block. TRUE - enable Read Keys on the Remote LCD keypad. FALSE - disable Read Keys on the Remote LCD keypad.
CKYL	Output	BOOL	TRUE: ESC key pressed for more than 2 seconds.
EKYL	Output	BOOL	TRUE: OK key pressed for more than 2 seconds.
CKY	Output	BOOL	TRUE: ESC key pressed.
EKY	Output	BOOL	TRUE: OK key pressed.
UKY	Output	BOOL	TRUE: Up key pressed.
DKY	Output	BOOL	TRUE: Down key pressed.
LKY	Output	BOOL	TRUE: Left key pressed.
RKY	Output	BOOL	TRUE: Right key pressed.

### KEY\_READ Function Block Diagram example

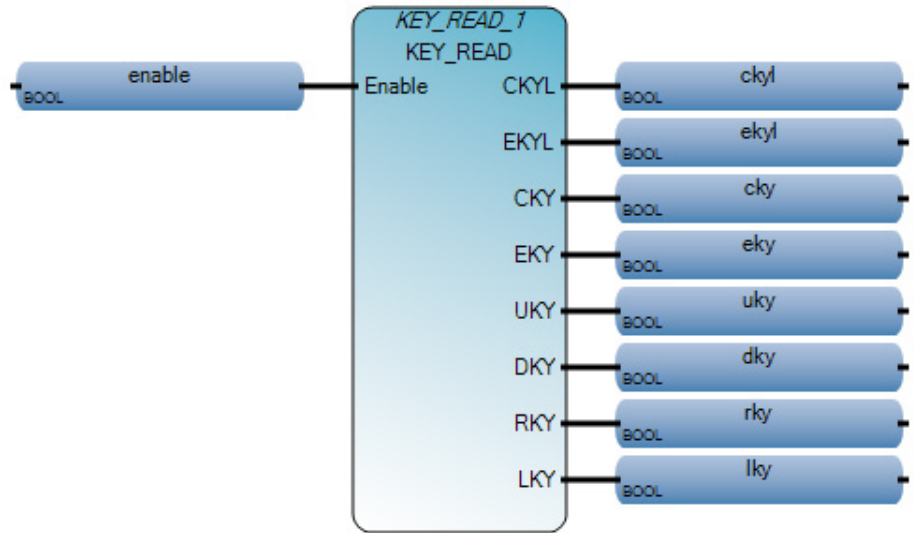

### KEY\_READ Ladder Diagram example

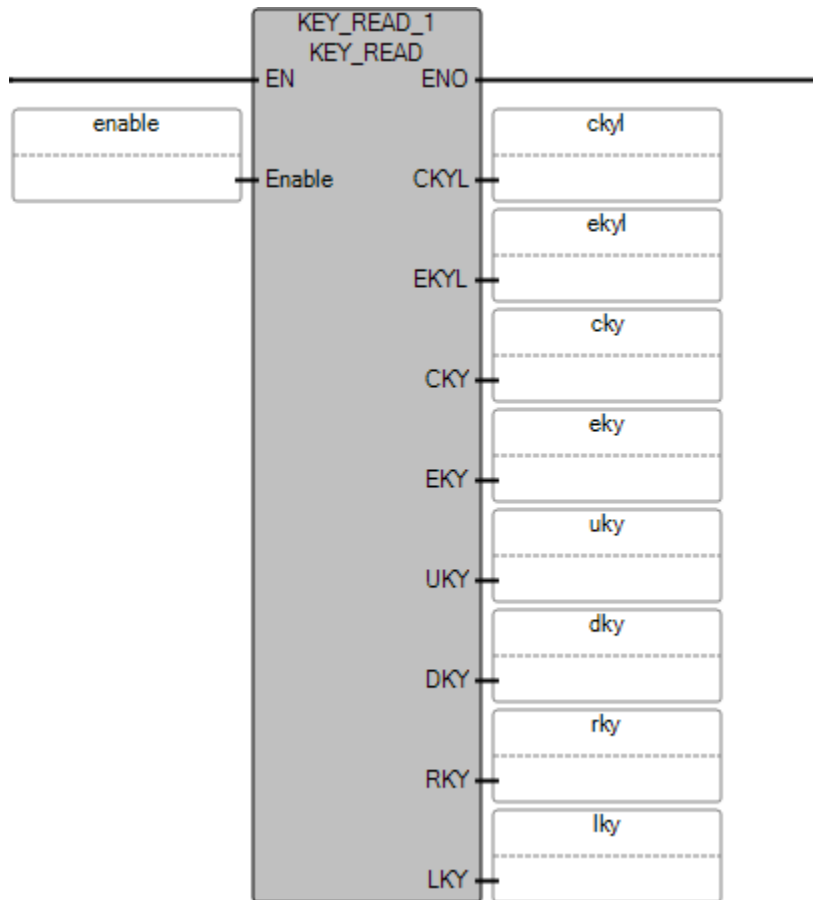

## KEY\_READ Structured Text example

```

KEY_READ_1(
void KEY_READ_1(BOOL Enable)
Type : KEY_READ, Read key status on option LCD module.

1 KEY_READ_1(enable);
2 cky1 := KEY_READ_1.CKYL;
3 ekyl := KEY_READ_1.EKYL;
4 cky := KEY_READ_1.CKY;
5 eky := KEY_READ_1.EKY;
6 uky := KEY_READ_1.UKY;
7 dky := KEY_READ_1.DKY;
8 lky := KEY_READ_1.LKY;
9 rky := KEY_READ_1.RKY;

```

(\* ST Equivalence: \*)

```

KEY_READ_1(KEYENABLE) ;
KEY_EKYL := KEY_READ_1.EKYL ;
KEY_CKY := KEY_READ_1.CKY ;
KEY_EKY := KEY_READ_1.EKY ;
KEY_UKY := KEY_READ_1.UKY ;
KEY_DKY := KEY_READ_1.DKY ;
KEY_RKY := KEY_READ_1.RKY ;
KEY_LKY := KEY_READ_1.LKY ;

```

## KEY\_READ\_REM (read keys for remote LCD)

Reads the Key status on the optional Remote LCD module when the user display is active.

Operation details:

- Use the LCD\_REM instruction to activate the user display on the Remote LCD module. If the user display is not active, an error occurs during KEY\_READ\_REM execution.
- P-BUTTON property in LCD Function File activates; otherwise all key status is FALSE.
- Only single key presses are supported for the KEY\_READ\_REM instruction; two-key press combinations are not supported.

Languages supported: Function Block Diagram, Ladder Diagram, Structured Text.

This instruction applies to the Micro820 controllers.

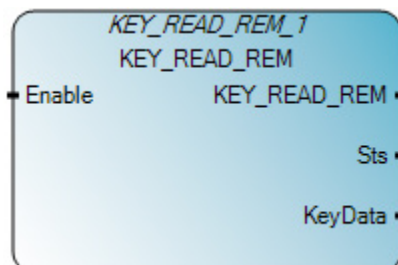

Use this table to help determine the parameter values for this instruction.

Parameter	Parameter Type	Data Type	Description
Enable	Input	BOOL	Instruction block enable. TRUE - Enable FALSE - Disable
KEY_READ_REM	Output	BOOL	TRUE - Remote LCD Key data is read successfully. FALSE - Enable is false, there is an error reading. Remote LCD Key Data or User Display is not active.
Sts	Output	UINT	Status of the KEY_READ_REM operation. KEY_READ_REM status codes: <ul style="list-style-type: none"> <li>• 0 - Enable Input is False.</li> <li>• 1 - Key data read successfully.</li> <li>• 2 - Remote LCD not detected.</li> </ul> May occur when: <ul style="list-style-type: none"> <li>• Remote LCD is not physically connected to the controller (or the wiring is incorrect).</li> <li>• Serial port settings are other than what is required for the Remote LCD.</li> </ul> <li>• 3 - Connection Error. May occur when there is an internal state machine error. Possible cause, an incompatibility between Controller FW version and RLCD FW version.</li> <li>• 4 - User Display is not active.</li> <li>• 5-65535 - Reserved.</li>
KeyData	Output	UDINT	Remote LCD KeyPad Data. KeyData definitions are defined in KeyData bitfields table.

### KeyData bitfields table

Use this table to help determine the KeyData bitfields for KEY\_READ\_REM.

Bit No. in KeyData	Name	Parameter Description
0	UKY	TRUE = Up key pressed.
1	DKY	TRUE = Down key pressed.
2	LKY	TRUE = Left key pressed.
3	RKY	TRUE = Right key pressed.
4	F1KY	TRUE = F1 key pressed.
5	F2KY	TRUE = F2 key pressed.
6	F3KY	TRUE = F3 key pressed.
7	F4KY	TRUE = F4 key pressed.
8	F5KY	TRUE = F5 key pressed.
9	F6KY	TRUE = F6 key pressed.
10	EKY	TRUE = Enter key pressed.
11	CKY	TRUE = Cancel key pressed.
12	EKYL	TRUE = Enter key pressed for more than 2 seconds.
13	CKYL	TRUE = Cancel key pressed for more than 2 seconds.
14-31	--	Reserved.



### KEY\_READ\_REM Function Block Diagram example

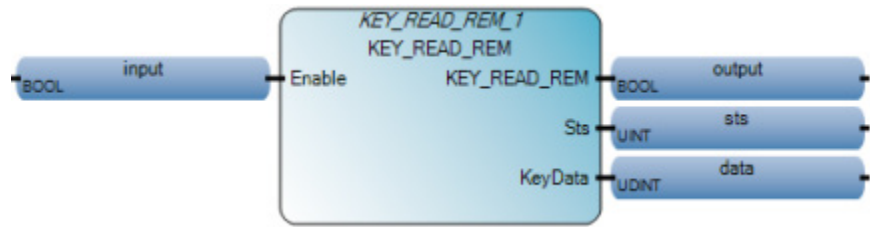

### KEY\_READ\_REM Ladder Diagram example

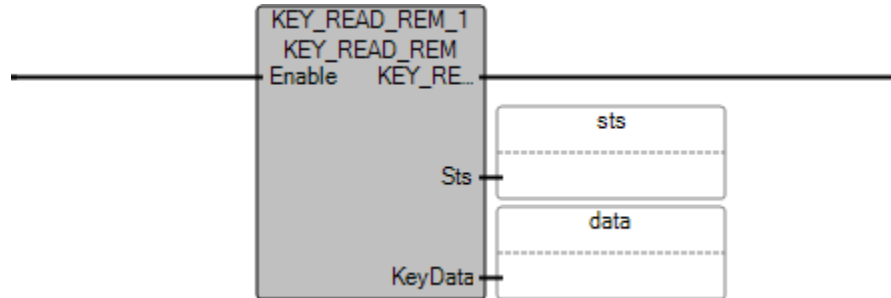

### KEY\_READ\_REM Structured Text example

```
KEY_READ_REM_2 (
void KEY_READ_REM_2(BOOL Enable)
Type : KEY_READ_REM, Check key status on remote LCD.

1 KEY_READ_REM (Enable);
2 output := KEY_READ_REM.ENO
3 sts := KEY_READ_REM.Sts
4 data := KEY_READ_REM.KeyData
```

## MM\_INFO (memory module information)

Reads Memory Module header information. When a Memory Module is not present, all values return zero (0).

Languages supported: Function Block Diagram, Ladder Diagram, Structured Text.

This instruction applies to the Micro810, Micro820, Micro830, Micro850, Micro870 controllers and Micro800 Simulator.

The outputs are always reset when the instruction is applied to the simulated controller (2080-LC50-48QWB-SIM).

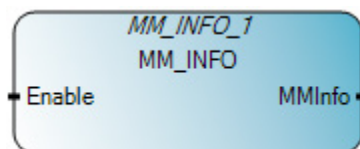

Use this table to help determine the parameter values for this instruction.

Parameter	Parameter Type	Data Type	Description
-----------	----------------	-----------	-------------

Enable	Input	BOOL	Instruction block enable. TRUE - read Memory Module header information. FALSE - there is no read operation, and the output Memory Module information is invalid.
MMInfo	Output	MMINFO	Memory Module Information is defined in the <a href="#">MMINFO data type</a> on <a href="#">page 363</a> .
ENO	Output	BOOL	Enable output. Applies only to Ladder Diagram programs.

### MM\_INFO Function Block Diagram example

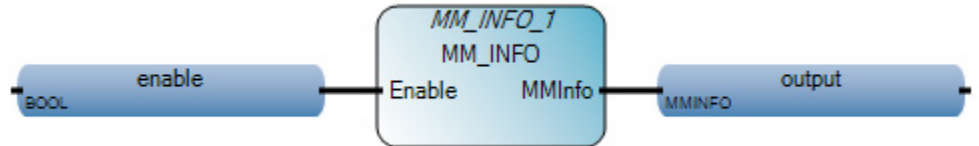

### MM\_INFO Ladder Diagram example

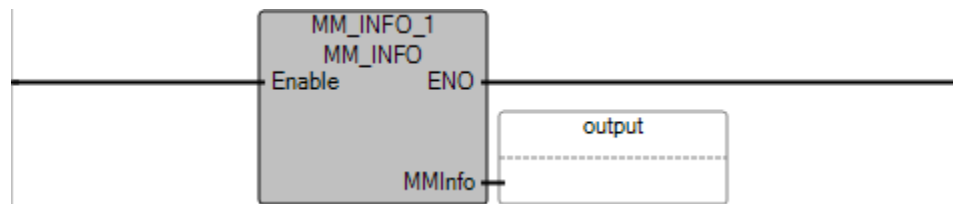

### MM\_INFO Structured Text example

```

MM_INFO_1(
void MM_INFO_1(BOOL Enable)
Type : MM_INFO, Read memory module header information.

1 MM_INFO_1(enable);
2 output := MM_INFO_1.MMInfo;

```

## Results

For controllers using 2080-MEMBAK-RTC:

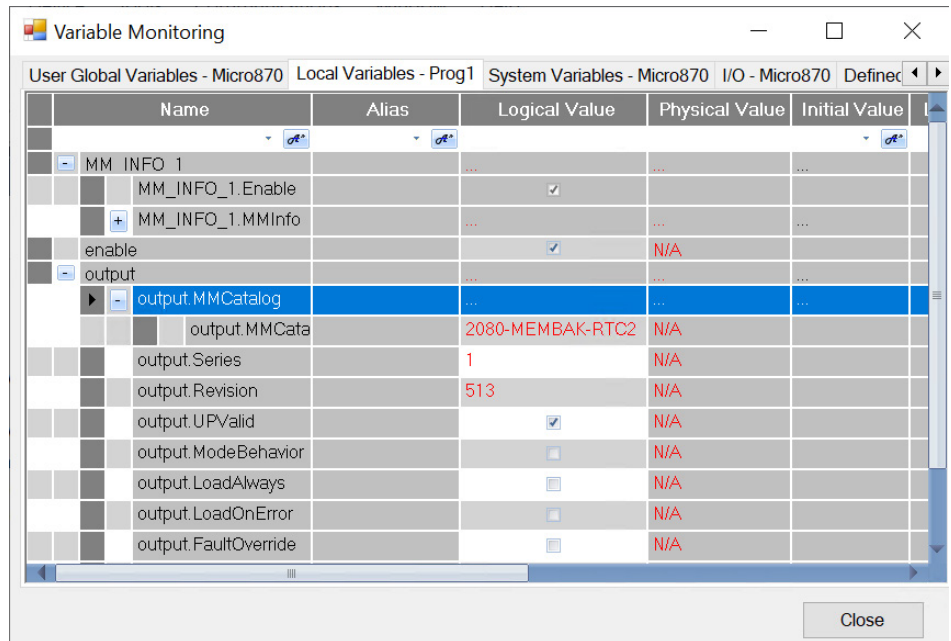

For controllers using an SD card:

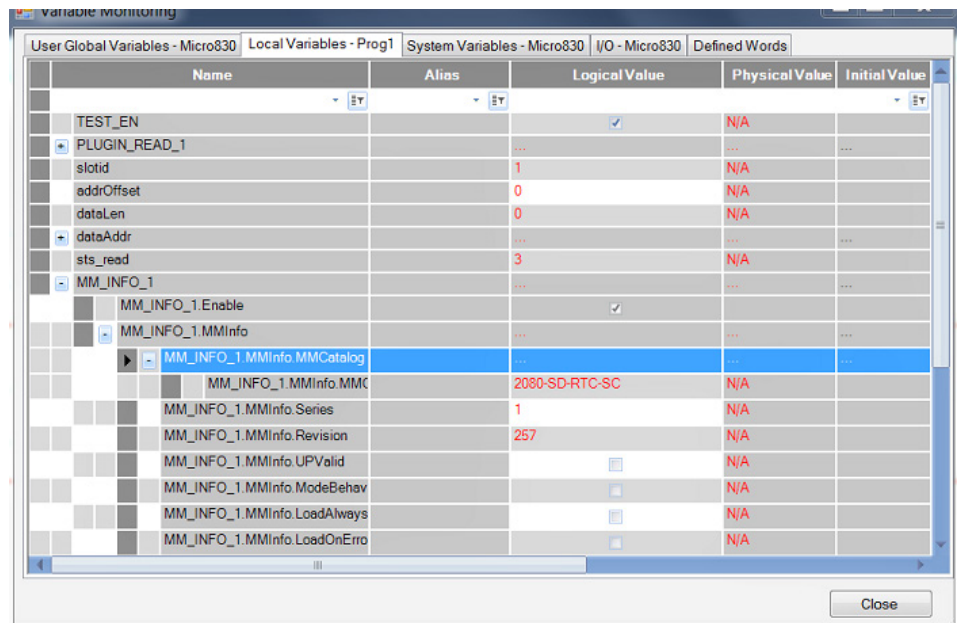

## MMINFO data type

The following table describes the MMINFO data type parameters.

Parameter	Data type	Description
MMCatalog	MMCATNUM	The catalog number of the Memory Module. When using the <a href="#">MM_INFO</a> on <a href="#">page 361</a> instruction on controllers with an SD card, the MMCatalog is "SD CARD".
Series	UINT	The series of the Memory Module. When using the MM_INFO instruction on controllers with an SD card, the series is 1.
Revision	UINT	The revision of the Memory Module. When using the MM_INFO on controllers with an SD card, the revision is 257.

Parameter	Data type	Description
UPValid	BOOL	User program is present (TRUE: possibly valid project is found). Note: Even if TRUE, there is still a possibility that the project will be detected during download or restore as invalid if individual files are missing or corrupt.
ModeBehavior	BOOL	Mode behavior (TRUE: Go to RUN on power up).
LoadAlways	BOOL	Memory Module restore to controller always on power up.
LoadOnError	BOOL	Memory Module restore to controller if power up with error.
FaultOverride	BOOL	Override fault on power up.
MMPresent	BOOL	Memory Module is present.

## MODULE\_INFO

Reads module information from a plug-in module or an expansion module.

Operation details:

- Plug-in module information is read during RUN time.
- The 2080-MEMBAK-RTC memory plug-in module is not supported.
- Expansion module information is read when the module is powered on.
- When a plug-in or expansion module is not defined with a ModuleID, ProductType, or ProductCode, the MODULE\_INFO operation returns 0 for the respective output parameter.
- The plug-in and expansion module identification information is defined by Allen-Bradley and is provided below as part of the MODULE\_INFO description.

Languages supported: Function Block Diagram, Ladder Diagram, Structured Text.

This instruction applies to the Micro820, Micro830, Micro850, and Micro870 controllers. Expansion modules are only supported on the Micro850 and Micro870 controllers.

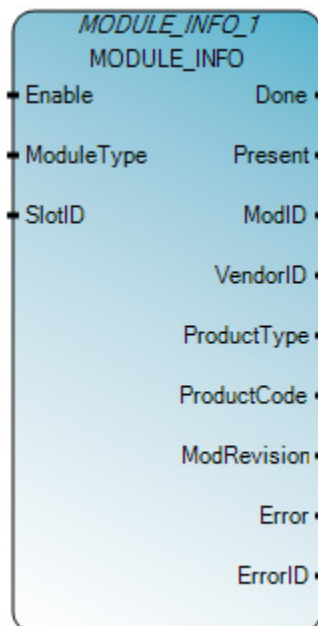

Use this table to help determine the parameter values for this instruction.

Parameter	Parameter Type	Data Type	Description
Enable	Input	BOOL	Instruction block enable. TRUE - executes MODULE_INFO read operation. FALSE - does not execute the read operation. All output data values are reset to 0.
ModuleType	Input	USINT	Identifies the module type: <ul style="list-style-type: none"> <li>• 1 - 2085 Expansion Module.</li> <li>• 2 - 2080 Plug-in Module.</li> </ul>
SlotID	Input	USINT	The slot number where the plug-in or expansion module is located. Slot IDs are: 1, 2, 3, 4, 5 Slot 1 is on the far left.
Done	Output	BOOL	TRUE - Operation completed successfully. FALSE - Operation is not executing or an error condition occurred.
Present	Output	BOOL	Detects the plug-in or expansion module in the controller slot. TRUE - Module is physically present. FALSE - Module is not physically present.
ModID	Output	UINT	The identification for the module in the controller slot. <ul style="list-style-type: none"> <li>• Plug-in modules are defined with a unique module identifier.</li> <li>• Expansion modules are not defined with a unique module identifier, ModID returns 0.</li> </ul>
VendorID	Output	UINT	The plug-in or expansion module vendor ID. For Allen-Bradley products, the vendor ID is 1.
ProductType	Output	UINT	The plug-in or expansion module product type.
ProductCode	Output	UINT	The plug-in or expansion module product code.
ModRevision	Output	UINT	The plug-in or expansion module revision information.
Error	Output	BOOL	Indicates the existence of an error condition. TRUE - An error is detected. FALSE - No error.
ErrorID	Output	USINT	A unique numeric that identifies the error. The errors are defined in the MODULE_INFO error codes.

### MODULE\_INFO error codes

Use this table to determine the MODULE\_INFO error codes and descriptions.

Error code	Error description
1	Invalid module type. Change to a valid module type. Valid module types are: 1 - 2085 Expansion Module. Only supported on Micro850 controllers. 2 - 2080 Plug-in Module. Supported on Micro820, Micro830, and Micro850 controllers.
2	Invalid slot number. Change to a valid slot number.
3	Invalid expansion module type.
4	Expansion module fatal error.
5	Plug-in module Read Info is not supported.
6	Plug-in module read error occurred while reading the Module ID.
7	Plug-in module read error occurred while reading the Vendor ID.
8	Plug-in module read error while reading the Product Type.
9	Plug-in module read error occurred while reading the Product Code.

Error code	Error description
1	Invalid module type. Change to a valid module type. Valid module types are: 1 - 2085 Expansion Module. Only supported on Micro850 controllers. 2 - 2080 Plug-in Module. Supported on Micro820, Micro830, and Micro850 controllers.
2	Invalid slot number. Change to a valid slot number.
3	Invalid expansion module type.
4	Expansion module fatal error.
5	Plug-in module Read Info is not supported.
10	Plug-in module read error occurred while reading the Module Revision.

### MODULE\_INFO Function Block Diagram example

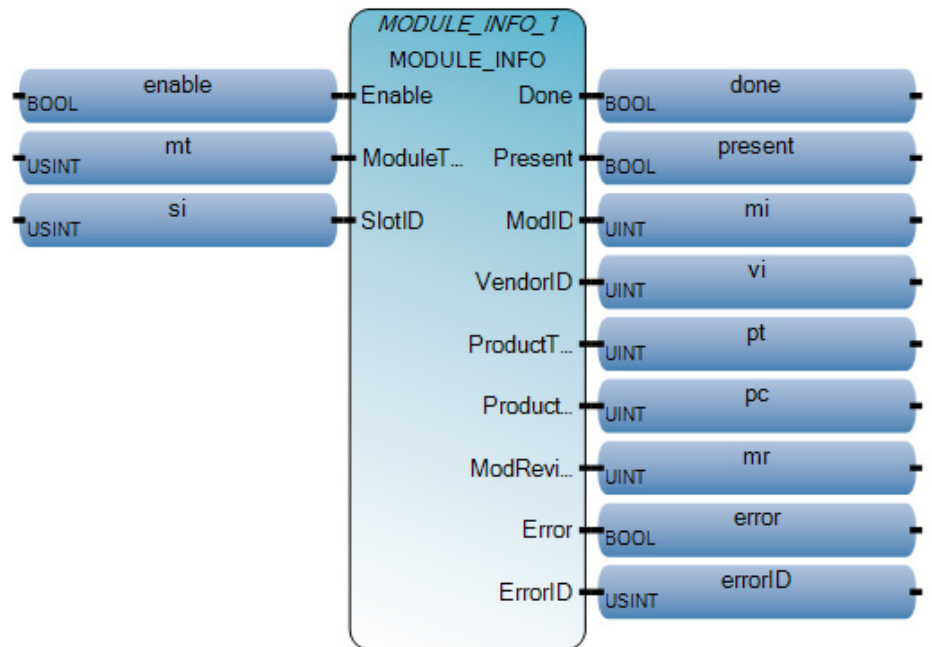

## MODULE\_INFO Ladder Diagram example

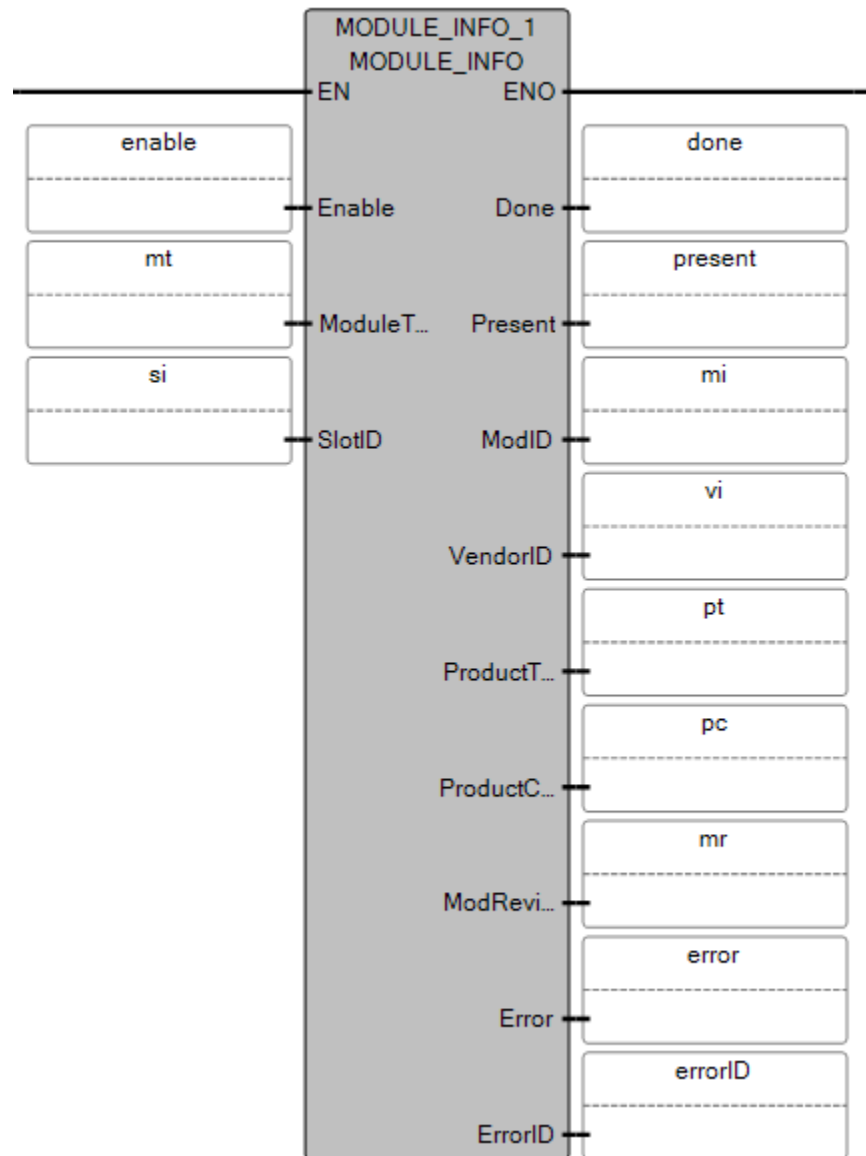

## MODULE\_INFO Structured Text example

```

1  MODULE_INFO_1(enable, mt, si);
2  done := MODULE_INFO_1.Done;
3  present :=MODULE_INFO_1.Present;
4  mi :=MODULE_INFO_1.ModID;
5  vi :=MODULE_INFO_1.VendorID;
6  pt :=MODULE_INFO_1.ProductType;
7  pc :=MODULE_INFO_1.ProductCode;
8  mr :=MODULE_INFO_1.ModRevision;
9  error :=MODULE_INFO_1.Error;
10 errorID :=MODULE_INFO_1.ErrorID;

```

```

MODULE_INFO_1(
void MODULE_INFO_1(BOOL Enable, USINT ModuleType, USINT SlotID)

```

## Results

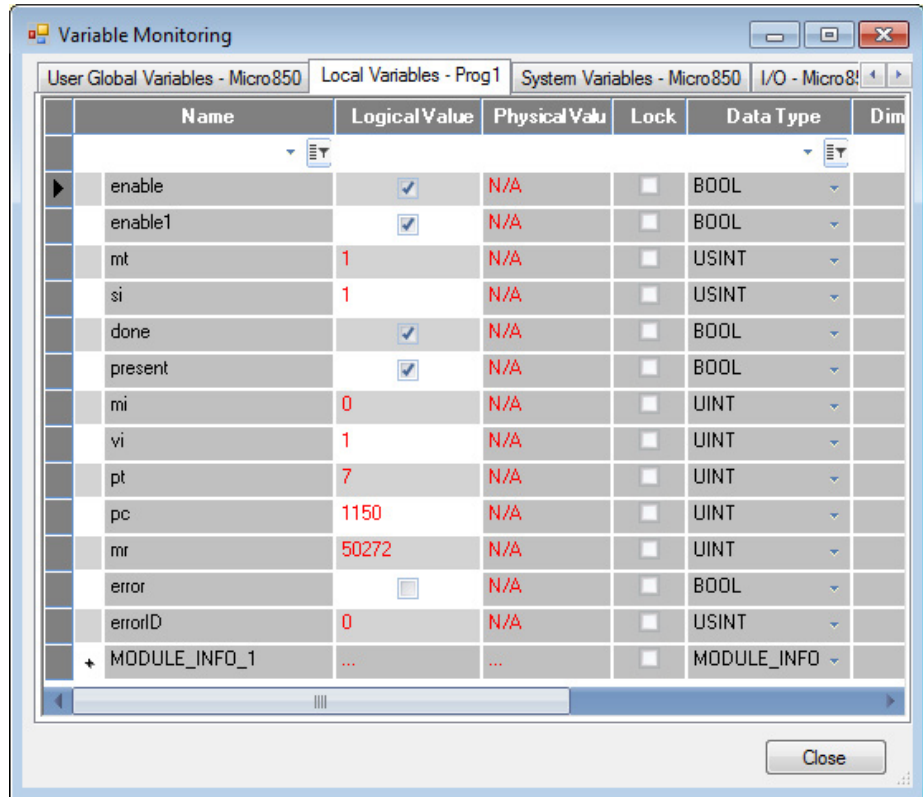

### MODULE\_INFO - plug-in and expansion module information

The following information provides the plug-in and expansion module Type, Module ID, Vendor ID, Product Codes and the Revision Word descriptions for expansion modules as defined by Allen-Bradley.

#### Plug-in module information

Use this table to determine the plug-in module information defined by Allen-Bradley.

Plug-in Module	Plug-in Type	Module ID	Vendor ID	Product Type	Product Code
2080-IF2	Analog	96	1	10	32
2080-IF4	Analog	98	1	10	33
2080-OF2	Analog	100	1	10	34
2080-TC2	Analog	102	1	10	35
2080-RTD2	Analog	104	1	10	36
2080-DNET20	Communication	34	1	12	249
2080-SERIALISOL	Communication	32	1	-	-
2080-IQ4	Digital	192	1	7	192
2080-OB4	Digital	193	1	7	193
2080-OV4	Digital	194	1	7	194
2080-IQ4OB4	Digital	195	1	7	195
2080-IQ4OV4	Digital	196	1	7	196
2080-OW4I	Digital	197	1	7	197
2080-MOT-HSC	Specialty	48	1	43	48



2080-TRIMPOT6	Specialty	72	1	-	-
---------------	-----------	----	---	---	---

## Expansion module information

Use this table to determine the expansion module information defined by Allen-Bradley.

Model number	Expansion Type	Module ID	Vendor ID	Product Type	Product Code
2085-IF4	Analog	-	1	10	208
2085-IF8	Analog	-	1	10	206
2085-IRT4	Analog	-	1	10	213
2085-OF4	Analog	-	1	10	214
2085-IA8	Digital	-	1	7	1148
2085-IM8	Digital	-	1	7	1152
2085-IQ16	Digital	-	1	7	1144
2085-IQ32T	Digital	-	1	7	1145
2085-OA8	Digital	-	1	7	1149
2085-OB16	Digital	-	1	7	1146
2085-OV16	Digital	-	1	7	1147
2085-OW16	Digital	-	1	7	1151
2085-OW8	Digital	-	1	7	1150

## Expansion module Revision Word descriptions

Use this table to determine the Revision Word information for Allen-Bradley expansion modules.

Bit	Name	Description
15 14	Max Baud Rate (1:0)	These bits identify the maximum frequency for Max Baud Rate (1:0). 00 (bin) is 2 Mbps 01 (bin) is 4 Mbps 10 (bin) is 8 Mbps 11 (bin) is 16 Mbps
13 12 11 10	Minor Revision (3:0)	Minor Revision (3:0) is the product minor revision designation. This field indicates the minor revision of the Catalog number designated by the Vendor ID, Product Type, Product Code, Series and Major Revision. The Minor Revision ranges from 0 to 15.
9 8 7 6 5	Major Revision (4:0)	Major Revision (4:0) is the product major revision designation. This field indicates the major revision of the Catalog number designated by the Vendor ID, Product Type, Product Code, and Series. The Major ranges from 0 to 31.

4	Series (4:0)	<p>SERIES (4:0) is the product Series designation. This field indicates the Series letter of the Catalog number designated by the Vendor ID, Product Type, and Product Code.</p> <table border="1" style="width: 100%; border-collapse: collapse;"> <thead> <tr> <th style="text-align: center;">Series (4:0)</th> <th style="text-align: center;">Series</th> <th style="text-align: center;">Series (4:0)</th> <th style="text-align: center;">Series</th> <th style="text-align: center;">Series (4:0)</th> <th style="text-align: center;">Series</th> <th style="text-align: center;">Series (4:0)</th> <th style="text-align: center;">Series</th> </tr> </thead> <tbody> <tr> <td style="text-align: center;">0</td> <td style="text-align: center;">A</td> <td style="text-align: center;">8</td> <td style="text-align: center;">I</td> <td style="text-align: center;">16</td> <td style="text-align: center;">Q</td> <td style="text-align: center;">24</td> <td style="text-align: center;">Y</td> </tr> <tr> <td style="text-align: center;">1</td> <td style="text-align: center;">B</td> <td style="text-align: center;">9</td> <td style="text-align: center;">J</td> <td style="text-align: center;">17</td> <td style="text-align: center;">R</td> <td style="text-align: center;">25</td> <td style="text-align: center;">Z</td> </tr> <tr> <td style="text-align: center;">2</td> <td style="text-align: center;">C</td> <td style="text-align: center;">10</td> <td style="text-align: center;">K</td> <td style="text-align: center;">18</td> <td style="text-align: center;">S</td> <td style="text-align: center;">26</td> <td style="text-align: center;">AA</td> </tr> <tr> <td style="text-align: center;">3</td> <td style="text-align: center;">D</td> <td style="text-align: center;">11</td> <td style="text-align: center;">L</td> <td style="text-align: center;">19</td> <td style="text-align: center;">T</td> <td style="text-align: center;">27</td> <td style="text-align: center;">AB</td> </tr> <tr> <td style="text-align: center;">4</td> <td style="text-align: center;">E</td> <td style="text-align: center;">12</td> <td style="text-align: center;">M</td> <td style="text-align: center;">20</td> <td style="text-align: center;">U</td> <td style="text-align: center;">28</td> <td style="text-align: center;">AC</td> </tr> <tr> <td style="text-align: center;">5</td> <td style="text-align: center;">F</td> <td style="text-align: center;">13</td> <td style="text-align: center;">N</td> <td style="text-align: center;">21</td> <td style="text-align: center;">V</td> <td style="text-align: center;">29</td> <td style="text-align: center;">AD</td> </tr> <tr> <td style="text-align: center;">6</td> <td style="text-align: center;">G</td> <td style="text-align: center;">14</td> <td style="text-align: center;">O</td> <td style="text-align: center;">22</td> <td style="text-align: center;">W</td> <td style="text-align: center;">30</td> <td style="text-align: center;">AE</td> </tr> <tr> <td style="text-align: center;">7</td> <td style="text-align: center;">H</td> <td style="text-align: center;">15</td> <td style="text-align: center;">P</td> <td style="text-align: center;">23</td> <td style="text-align: center;">X</td> <td style="text-align: center;">31</td> <td style="text-align: center;">&gt;AE</td> </tr> </tbody> </table>	Series (4:0)	Series	Series (4:0)	Series	Series (4:0)	Series	Series (4:0)	Series	0	A	8	I	16	Q	24	Y	1	B	9	J	17	R	25	Z	2	C	10	K	18	S	26	AA	3	D	11	L	19	T	27	AB	4	E	12	M	20	U	28	AC	5	F	13	N	21	V	29	AD	6	G	14	O	22	W	30	AE	7	H	15	P	23	X	31	>AE
Series (4:0)	Series	Series (4:0)	Series	Series (4:0)	Series	Series (4:0)	Series																																																																			
0	A	8	I	16	Q	24	Y																																																																			
1	B	9	J	17	R	25	Z																																																																			
2	C	10	K	18	S	26	AA																																																																			
3	D	11	L	19	T	27	AB																																																																			
4	E	12	M	20	U	28	AC																																																																			
5	F	13	N	21	V	29	AD																																																																			
6	G	14	O	22	W	30	AE																																																																			
7	H	15	P	23	X	31	>AE																																																																			

### MODULE\_INFO instruction timing diagrams

The following timing diagram examples describe execution scenarios for the [MODULE\\_INFO instruction](#) on [page 364](#).

#### Successful execution when a module is physically present

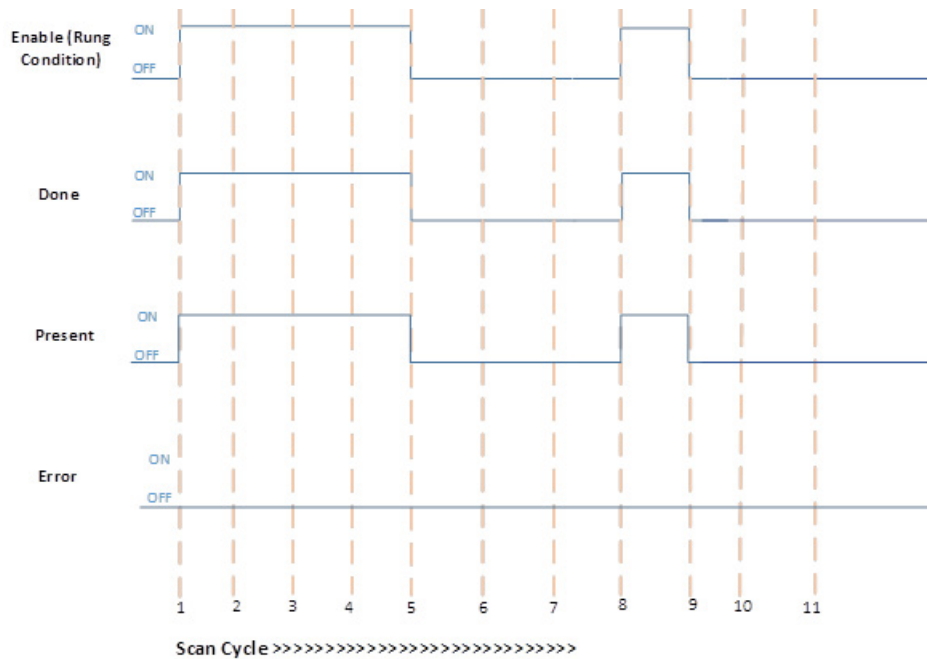

Use this table to help determine the MODULE\_INFO parameter values for each scan cycle.

Scan Cycle	Description

Scan Cycle	Description
1, 8	Rung condition becomes TRUE when: <ul style="list-style-type: none"> <li>• Enable input bit is TRUE.</li> <li>• ModuleType and SlotID are valid. A physical module is present.</li> <li>• Done and Present output bits are TRUE.</li> <li>• Error output bit is FALSE.</li> <li>• Update module related information for Module ID, Vendor ID, Product Type, Product Code, and Module Revision accordingly.</li> </ul>
2,3,4	No change in rung condition.
5, 9	Rung condition becomes FALSE when Enable bit is FALSE. All output parameters are cleared.
6, 7, 10, 11	No change in rung condition. Enable bit is FALSE. All output parameters are cleared.

### Successful execution when Module is not physically present

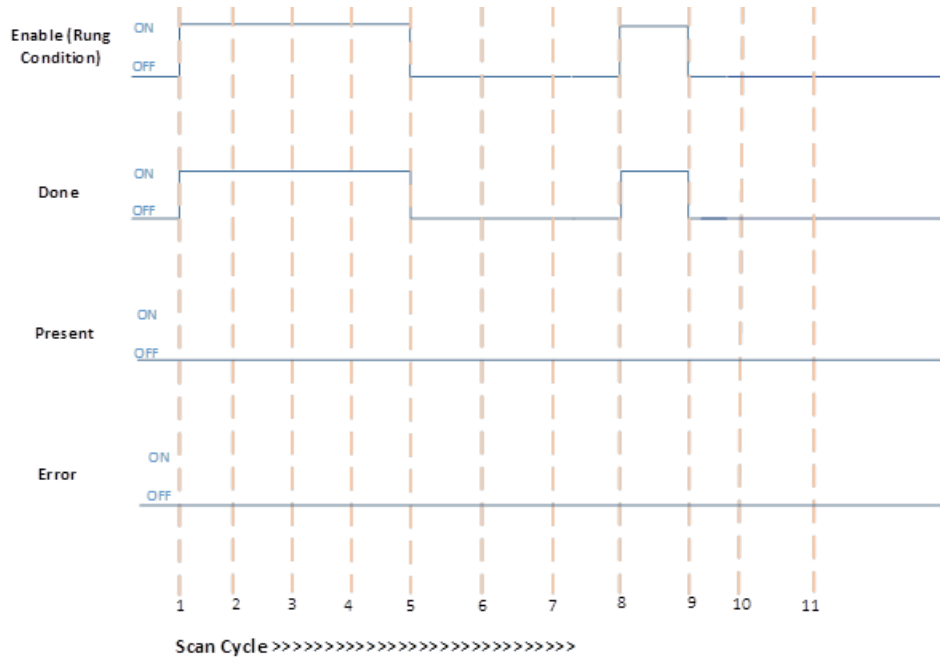

Use this table to help determine the MODULE\_INFO parameter values for each scan cycle.

Scan Cycle	Description
1, 8	Rung condition becomes TRUE when: <ul style="list-style-type: none"> <li>• Enable input bit is TRUE.</li> <li>• ModuleType and SlotID are valid. A physical module is not present.</li> <li>• Done output bit is TRUE.</li> <li>• Error and Present output bits are FALSE.</li> <li>• Update module related information for Module ID, Vendor ID, Product Type, Product Code, and Module Revision accordingly.</li> </ul>
2,3,4	No change in rung condition. <ul style="list-style-type: none"> <li>• Enable input bit is TRUE.</li> <li>• Input parameters are valid and a physical module is not present.</li> <li>• Update output parameters accordingly.</li> </ul>

Scan Cycle	Description
5, 9	Rung condition becomes FALSE when: <ul style="list-style-type: none"> <li>• Enable bit is FALSE.</li> <li>• All output parameters are cleared.</li> </ul>
6, 7, 10, 11	No change in rung condition. Enable bit is FALSE. All output parameters are cleared.

### MODULE\_INFO execution with Error

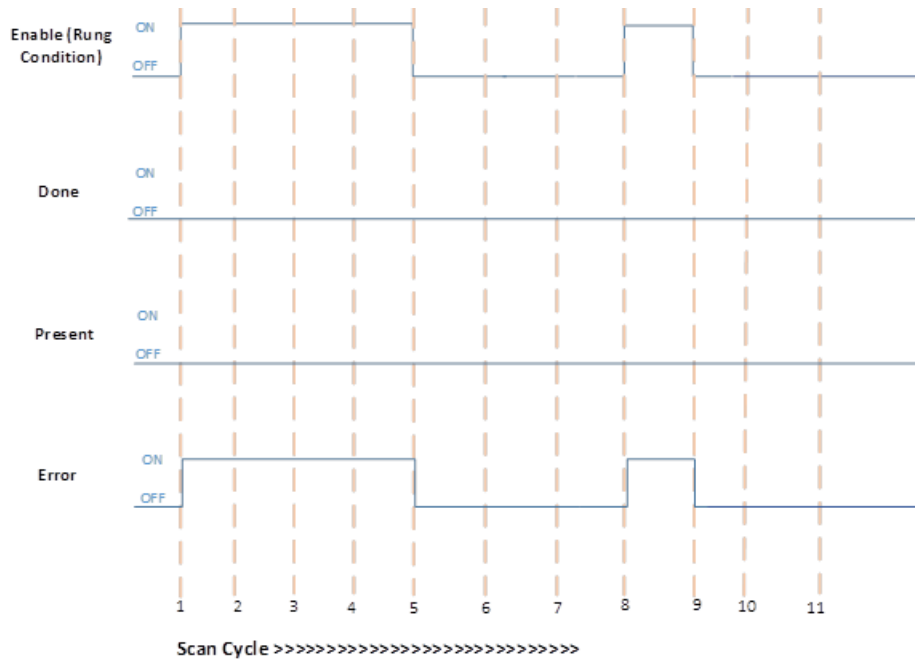

Use this table to help determine the MODULE\_INFO parameter values for each scan cycle.

Scan Cycle	Description
1, 8	Rung condition becomes TRUE when: <ul style="list-style-type: none"> <li>• Enable input bit is TRUE.</li> <li>• ModuleType and SlotID are valid. A physical module is not present.</li> <li>• Done and Present output bits are TRUE.</li> <li>• Error output bit is TRUE.</li> <li>• Module related information for Module ID, Vendor ID, Product Type, Product Code, and Module Revision is cleared.</li> </ul>
2,3,4	No change in rung condition. <ul style="list-style-type: none"> <li>• Enable input bit is TRUE.</li> <li>• ModuleType, SlotID, or both are invalid.</li> <li>• Update output parameters accordingly.</li> </ul>
5, 9	Rung condition becomes FALSE when: <ul style="list-style-type: none"> <li>• Enable bit is FALSE.</li> <li>• All output parameters are cleared.</li> </ul>
6, 7, 10, 11	No change in rung condition. Enable bit is FALSE. All output parameters are cleared.

### MODULE\_INFO successful execution with error - no physical module

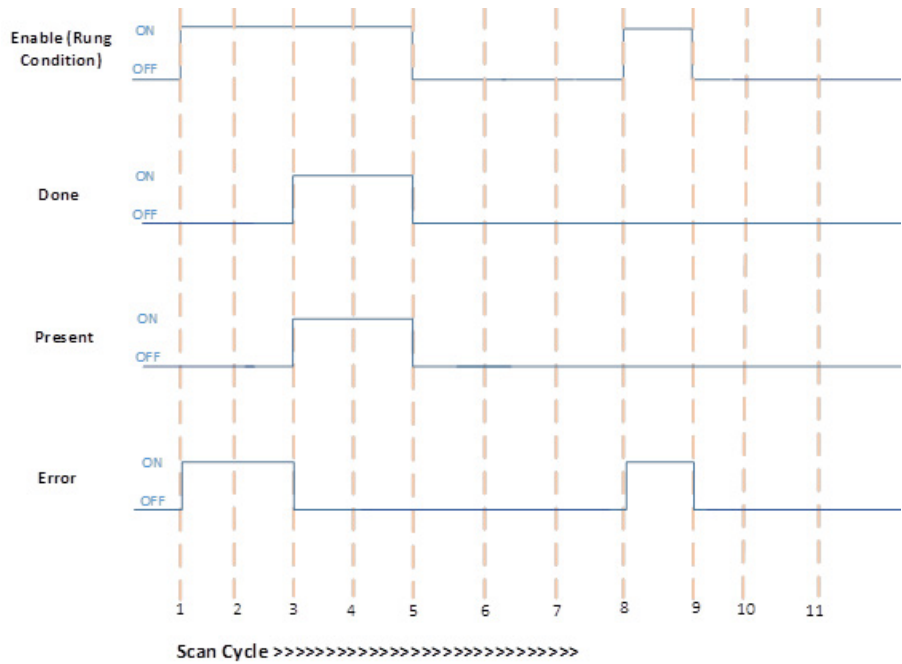

Use this table to help determine the MODULE\_INFO parameter values for each scan cycle.

Scan Cycle	Description
1, 8	Rung condition becomes TRUE when: <ul style="list-style-type: none"> <li>• Enable input bit is TRUE.</li> <li>• ModuleType or SlotID or both are invalid. A physical Module is not present.</li> <li>• Done and Present output bits are FALSE.</li> <li>• Error output bit is TRUE.</li> <li>• Module related information for Module ID, Vendor ID, Product Type, Product Code, and Module Revision is cleared.</li> </ul>
2	No change in rung condition. <ul style="list-style-type: none"> <li>• Enable input bit is TRUE.</li> <li>• ModuleType or SlotID or both are invalid.</li> <li>• Update output parameters accordingly.</li> </ul>
3, 4	No change in rung condition. <ul style="list-style-type: none"> <li>• Enable input bit is TRUE.</li> <li>• ModuleType and SlotID are both are valid. Module is physically present.</li> <li>• Done and Present output bits are TRUE.</li> <li>• Error output bit is FALSE.</li> <li>• Update module information for Module ID, Vendor ID, Product Type, Product Code, and Module Revision accordingly.</li> </ul>
5, 9	Rung condition becomes FALSE when: <ul style="list-style-type: none"> <li>• Enable bit is FALSE.</li> <li>• All output parameters are cleared.</li> </ul>
6, 7, 10, 11	No change in rung condition. Enable bit is FALSE. All output parameters are cleared.

## MODULE\_INFO successful execution with error when physical module is present

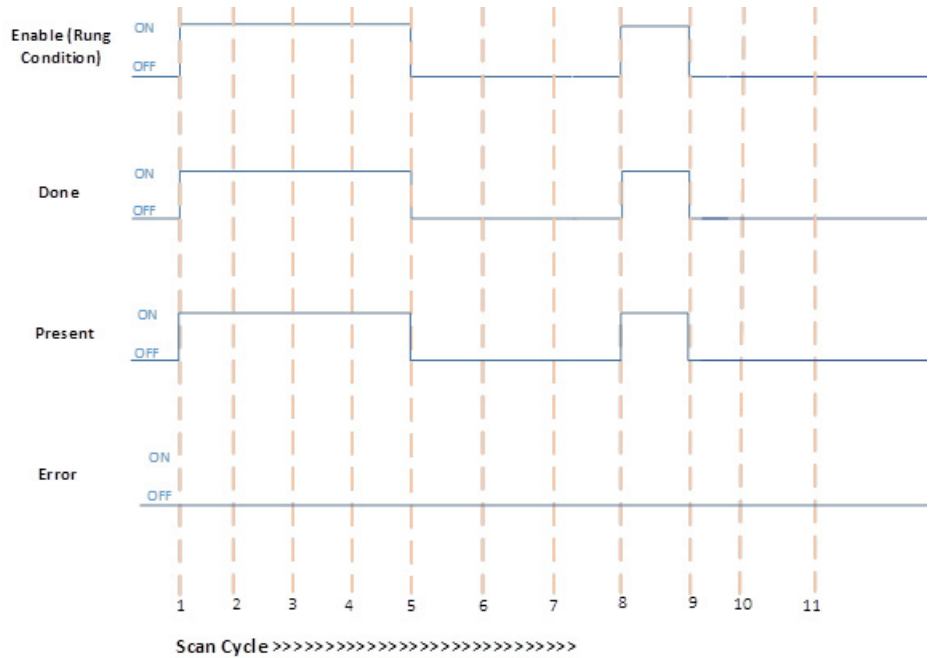

Use this table to help determine the MODULE\_INFO parameter values for each scan cycle.

Scan Cycle	Description
1, 8	Rung condition becomes TRUE when: <ul style="list-style-type: none"> <li>• Enable input bit is TRUE.</li> <li>• ModuleType or SlotID or both are valid. Module is physically present.</li> <li>• Done and Present output bits are TRUE.</li> <li>• Error output bit is FALSE</li> <li>• Update module related information for Module ID, Vendor ID, Product Type, Product Code, and Module Revision accordingly.</li> </ul>
2	No change in rung condition. <ul style="list-style-type: none"> <li>• Enable input bit is TRUE.</li> <li>• Module input parameters are valid and module is physically present.</li> <li>• Update output parameters accordingly.</li> </ul>
3, 4	No change in rung condition. <ul style="list-style-type: none"> <li>• Enable input bit is TRUE.</li> <li>• ModuleType and SlotID are both are invalid. Module is physically present.</li> <li>• Done and Present output bits are FALSE.</li> <li>• Error output bit is TRUE and cleared.</li> <li>• Update module information for Module ID, Vendor ID, Product Type, Product Code, and Module Revision accordingly.</li> </ul>
5, 9	Rung condition becomes FALSE when: <ul style="list-style-type: none"> <li>• Enable bit is FALSE.</li> <li>• All output parameters are cleared.</li> </ul>
6, 7, 10, 11	No change in rung condition. Enable bit is FALSE. All output parameters are cleared.

## PLUGIN\_INFO (plug-in information)

Read module information from a generic Plug-in or Expansion module.

Operation details:

- In Connected Components Workbench 10 or higher, the PLUGIN\_INFO instruction can read any generic Plug-in or Expansion Module information, except the 2080-MEMBAK-RTC module.
- When a generic Plug-in or Expansion Module is not present, all values return to zero (0).

Languages supported: Function Block Diagram, Ladder Diagram, Structured Text.

This instruction applies to the Micro820, Micro830, Micro850, and Micro870 controllers.

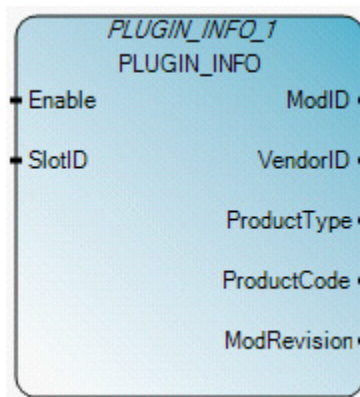

Use this table to help determine the parameter values for this instruction.

Parameter	Parameter Type	Data Type	Description
Enable	Input	BOOL	Instruction block enable. TRUE - execute Plug-in or Expansion module information read. FALSE - the instruction block is not executed. All output data values are reset to 0.
SlotID	Input	UINT	Plug-in Slot number: Slot ID = 1,2,3,4,5 (Starting with the first Slot from left = 1).  Expansion Slot number: Slot ID = 101, 102, 103, 104 (Starting with the first Slot from left = 101).
ModID	Output	UINT	Plug-in Generic Module physical ID. • If the Expansion Module is not supported ModID = 0xFFFF • If a Plug-in or Expansion Module is not present ModID = 0x0000
VendorID	Output	UINT	The Plug-in or Expansion Generic Module vendor ID. For Allen Bradley products, the vendor ID = 1. If a Plug-in or Expansion Module is not present VendorID = 0x0000
ProductType	Output	UINT	Plug-in or Expansion Generic Module product type. If a Plug-in or Expansion Module is not present ProductType = 0x0000

ProductCode	Output	UINT	Plug-in or Expansion Generic Module product code. If a Plug-in or Expansion Module is not present ProductCode = 0x0000
ModRevision	Output	UINT	Plug-in or Expansion Generic Module revision information. If a Plug-in or Expansion Module is not present ModRevision = 0x0000
ENO	Output	BOOL	Enable output. Applies only to Ladder Diagram programs. Ladder Diagram adds the ENO output automatically.

**PLUGIN\_INFO Function Block Diagram example**

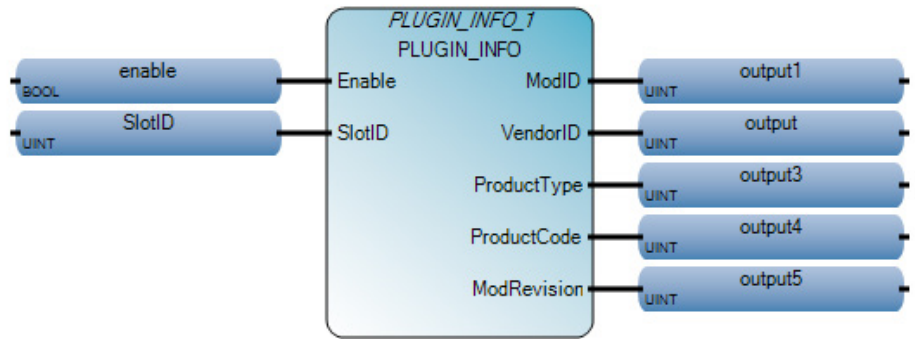

**PLUGIN\_INFO Ladder Diagram example**

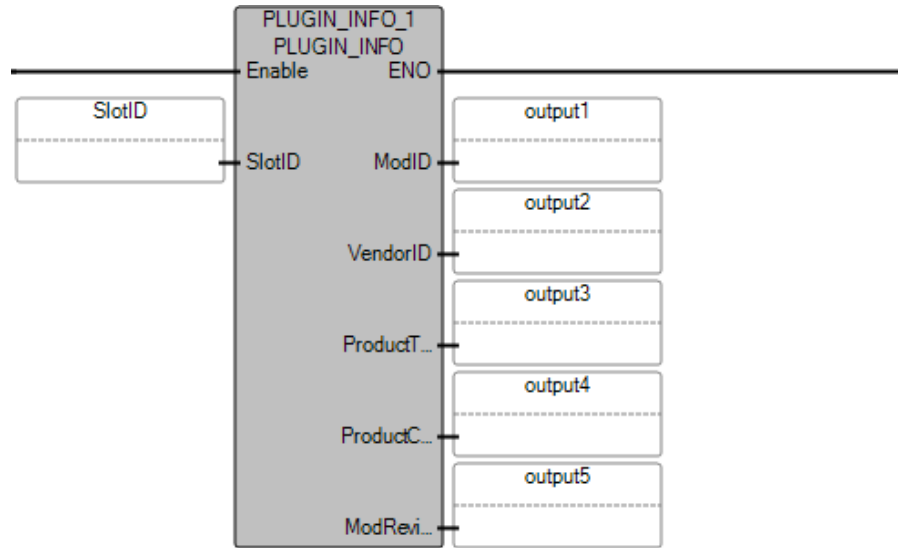



## PLUGIN\_INFO Structured Text example

```

PLUGIN_INFO_1(
void PLUGIN_INFO_1(BOOL Enable, UINT SlotID)
Type : PLUGIN_INFO, Get module information from a generic plug-in module.

1 SlotID := 1;
2 PLUGIN_INFO_1(enable, SlotID);
3 output1 := PLUGIN_INFO_1.ModID;
4 output2 := PLUGIN_INFO_1.VendorID;
5 output3 := PLUGIN_INFO_1.ProductType;
6 output4 := PLUGIN_INFO_1.ProductCode;
7 output5 := PLUGIN_INFO_1.ModRevision;

```

## Results

The screenshot shows the 'Variable Monitoring' window with the following data:

Name	Logical Value	Physical Value	Lock	Data Type
enable	<input checked="" type="checkbox"/>	N/A	<input type="checkbox"/>	BOOL
SlotID	1	N/A	<input type="checkbox"/>	UINT
output1	0	N/A	<input type="checkbox"/>	UINT
output2	0	N/A	<input type="checkbox"/>	UINT
output3	0	N/A	<input type="checkbox"/>	UINT
output4	0	N/A	<input type="checkbox"/>	UINT
output5	0	N/A	<input type="checkbox"/>	UINT
PLUGIN_INFO_1	...	...	<input type="checkbox"/>	PLUGIN_IN

**PLUGIN\_READ (read plugin)** Reads data from a generic plug-in module.

Operation details:

- Any plug-in module except for 2080-MEMBAK-RTC modules.
- When a Plug-in Generic Module is not present, all values return to zero (0).

Languages supported: Function Block Diagram, Ladder Diagram, Structured Text.

This instruction applies to the Micro820, Micro830, Micro850, and Micro870 controllers.

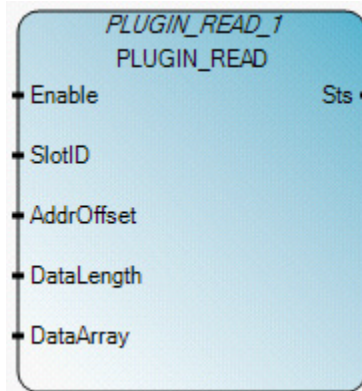

Use this table to help determine the parameter values for this instruction.

Parameter	Parameter Type	Data Type	Description
Enable	Input	BOOL	Instruction block enable. TRUE - execute UPM read. FALSE - there is no read operation and the data inside the data array is invalid.
SlotID	Input	UINT	Plug-in slot number. Slot ID = 1,2,3,4,5 (starting with the far left slot = 1).
Offset	Input	UINT	Address offset of the first data to be read, calculating from the first byte of the Plug-in Generic Module.
DataLength	Input	UINT	The number of bytes to be read.
DataArray	Input	USINT	An array used to store the data read from the Plug-in Generic Module.
Sts	Output	UINT	Status codes for PLUGIN_READ. Status (Sts) codes: <ul style="list-style-type: none"> <li>• 0x00 - Function block not enabled (no operation).</li> <li>• 0x01 - Plug-in operation success.</li> <li>• 0x02 - Plug-in operation fails due to an invalid Slot ID.</li> <li>• 0x03 - Plug-in operation fails since it is not a valid Plug-in Generic module.</li> <li>• 0x04 - Plug-in operation fails due to data operated out of range.</li> <li>• 0x05 - Plug-in operation fails due to a data access parity error.</li> </ul>
ENO	Output	BOOL	Enable output. Applies only to Ladder Diagram programs.

### PLUGIN\_READ Function Block Diagram example

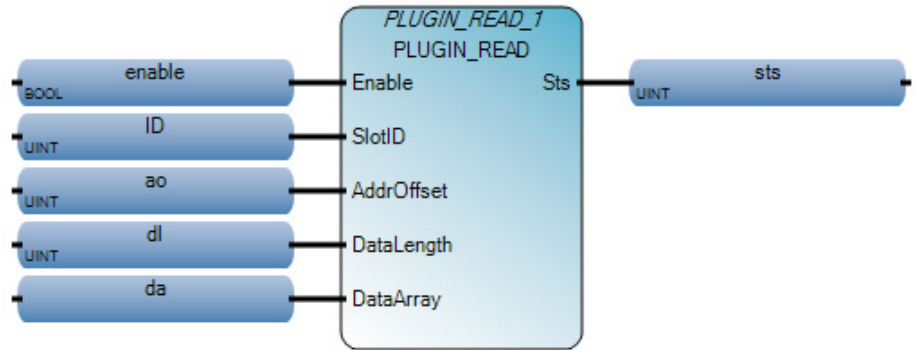

### PLUGIN\_READ Ladder Diagram example

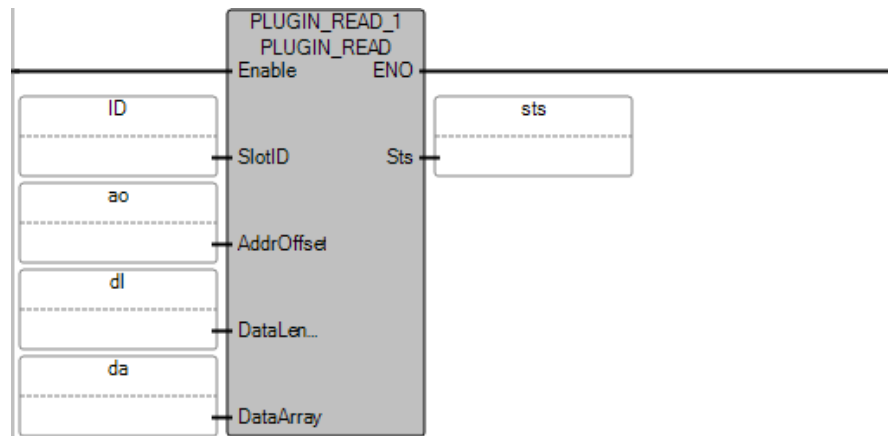

### PLUGIN\_READ Structured Text example

```
PLUGIN_READ_1(
void PLUGIN_READ_1(BOOL Enable, UINT SlotID, UINT AddrOffset, UINT DataLength, USINT[1..1] DataArray)
Type : PLUGIN_READ, Read data from a generic PLUGIN module.
```

```
1 | PLUGIN_READ_1(enable, ID, ao, dl, da);
2 | sts := PLUGIN_READ_1.Sts;
```

### PLUGIN\_RESET (reset plugin)

Resets any Plug-in Generic Module hardware except 2080-MEMBAK-RTC modules. After the hardware reset, the Plug-in Generic Module is ready for configuration and operation.

Languages supported: Function Block Diagram, Ladder Diagram, Structured Text.

This instruction applies to the Micro820, Micro830, Micro850, and Micro870 controllers.



Use this table to help determine the parameter values for this instruction.

Parameter	Parameter Type	Data Type	Description
Enable	Input	BOOL	Instruction block enable. TRUE - execute Plug-in reset. FALSE - there is no reset operation.
SlotID	Input	UINT	Plug-in slot number. Slot ID = 1,2,3,4,5 (starting with the far left slot = 1).
Sts	Output	UINT	PLUGIN_RESET status codes. Status (Sts) codes: <ul style="list-style-type: none"> <li>• 0x00 - Function block not enabled (no operation).</li> <li>• 0x01 - Plug-in operation success.</li> <li>• 0x02 - Plug-in operation fails due to an invalid Slot ID.</li> <li>• 0x03 - Plug-in operation fails since it is not a valid Plug-in Generic module. -2080-MOT-HSC module configuration is in High Speed Counter Instruction mode.</li> <li>• 0x04 - Plug-in operation fails due to data operated out of range.</li> <li>• 0x05 - Plug-in operation fails due to a data access parity error.</li> </ul>
ENO	Output	BOOL	Enable output. Applies only to Ladder Diagram programs.

### PLUGIN\_RESET Function Block Diagram example

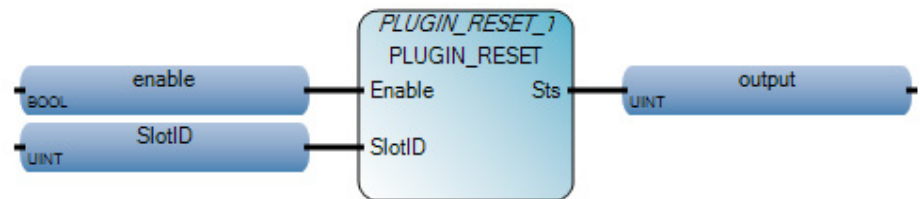

### PLUGIN\_RESET Ladder Diagram example

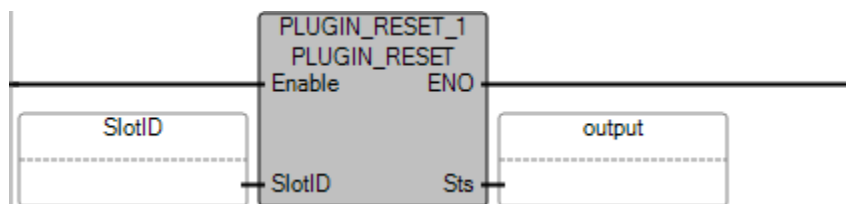

### PLUGIN\_RESET Structured Text example

```

PLUGIN_RESET_1(
void PLUGIN_RESET_1(BOOL Enable, UINT SlotID)
Type : PLUGIN_RESET, Reset a generic PLUGIN module(hardware reset).

1 SlotID := 1;
2 PLUGIN_RESET_1(enable, SlotID);
3 output := PLUGIN_RESET_1.Sts;
    
```

### Results

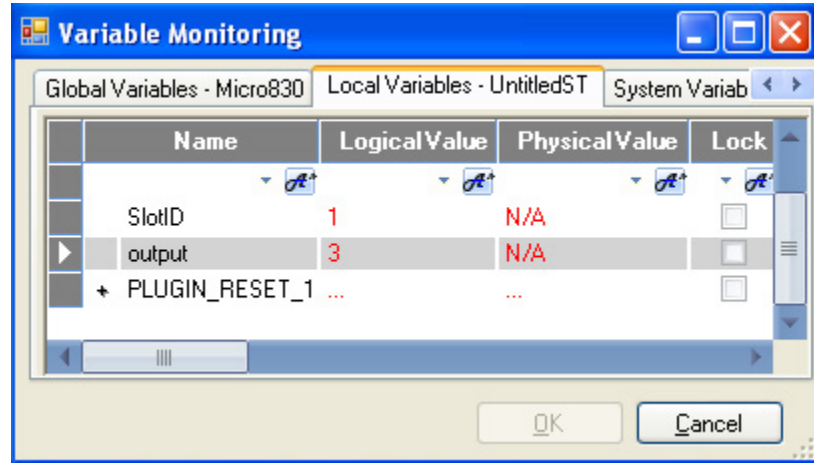

### PLUGIN\_WRITE (write plugin)

Writes a block of data to any Plug-in Generic Module hardware except 2080-MEMBAK-RTC modules.

Languages supported: Function Block Diagram, Ladder Diagram, Structured Text.

This instruction applies to the Micro820, Micro830, Micro850, and Micro870 controllers.



Use this table to help determine the parameter values for this instruction.

Parameter	Parameter Type	Data Type	Description
Enable	Input	BOOL	Instruction block enable. TRUE - execute Plug-in write. FALSE - there is no data write operation.

SlotID	Input	UINT	Plug-in slot number. Slot ID = 1,2,3,4,5 (starting with the far left slot = 1).
AddrOffset	Input	UINT	Address offset of the first data to be written, calculating from the first byte of the Plug-in Generic Module.
DataLength	Input	UINT	The number of bytes to be written.
dataArray	Input	USINT	Data to be written to the Plug-in Generic Module.
Sts	Output	UINT	PLUGIN_WRITE status codes. Status (Sts) codes: <ul style="list-style-type: none"> <li>• 0x00 - Function block not enabled (no operation).</li> <li>• 0x01 - Plug-in operation success.</li> <li>• 0x02 - Plug-in operation fails due to an invalid Slot ID.</li> <li>• 0x03 - Plug-in operation fails since it is not a valid Plug-in Generic module.</li> <li>• 0x04 - Plug-in operation fails due to data operated out of range.</li> <li>• 0x05 - Plug-in operation fails due to a data access parity error.</li> </ul>
ENO	Output	BOOL	Enable output. Applies only to Ladder Diagram programs.

### PLUGIN\_WRITE Function Block Diagram example

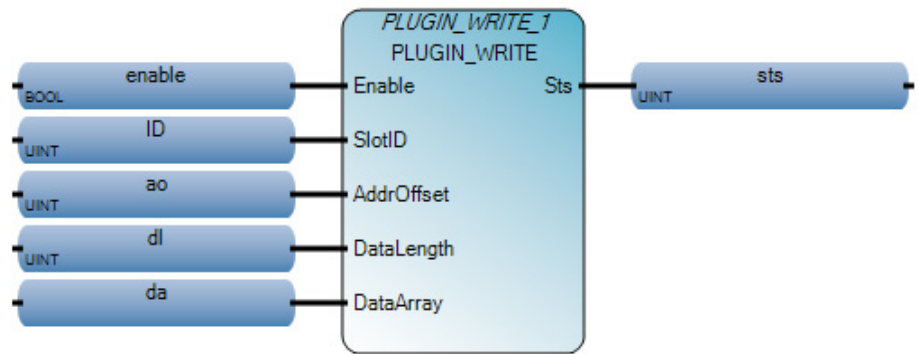

### PLUGIN\_WRITE Ladder Diagram example

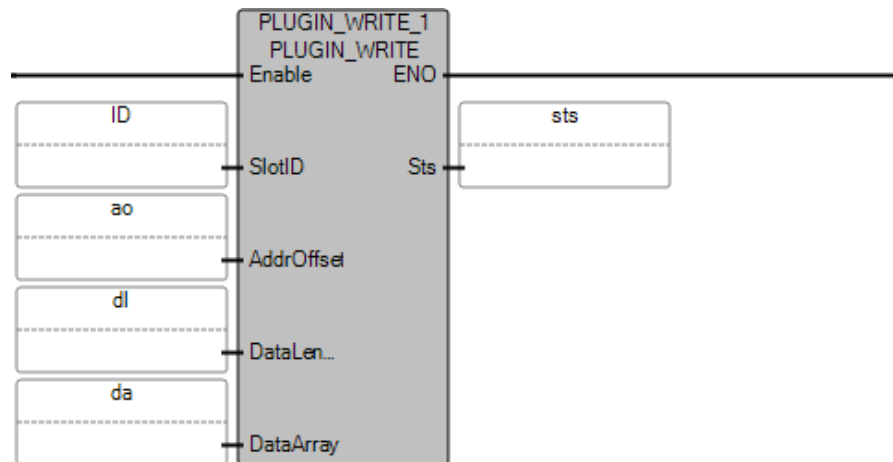

## PLUGIN\_WRITE Structured Text example

```
PLUGIN_WRITE_1(
void PLUGIN_WRITE_1(BOOL Enable, UINT SlotID, UINT AddrOffset, UINT DataLength, USINT[1..1] DataArray)
Type: PLUGIN_WRITE, Write data to a generic PLUGIN module.
```

```
1 PLUGIN_WRITE_1(enable, ID, ao, dl, da);
2 sts := PLUGIN_WRITE_1.Sts;
```

## RCP (recipe)

Reads the data value of a variable from the recipe data file that resides in the recipe data file folder in the SD card and updates the value to the run-time engine. Writes the variable value with the run-time engine to the recipe data file in the SD card.

Languages supported: Function Block Diagram, Ladder Diagram, Structured Text.

This instruction applies to the Micro820, Micro830, Micro850, and Micro870 controllers.

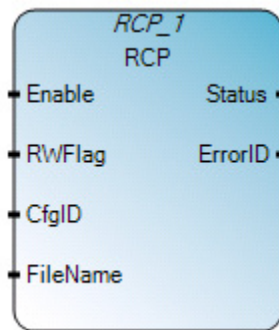

Use this table to help determine the parameter values for this instruction.

Parameter	Parameter Type	Data Type	Description
Enable	Input	BOOL	Enable recipe read/write instruction block. TRUE - Rising Edge detected, execute recipe instruction if the previous operation is completed. FALSE - Rising Edge not detected, do not execute recipe instruction.
RWFlag	Input	BOOL	TRUE - RWFlag (Write operation). Recipe writes the the variable's values with the run-time engine into a recipe data file on the SD card. FALSE - RWFlag (Read operation). The recipe reads the variable's values from the SD card and updates the corresponding variable's value to the runtime engine.
CfgID	Input	USINT	Recipe configuration VA ID number 1-10.
FileName	Input	STRING	Recipe data file name (maximum 30 characters length).
Status	Output	USINT	Recipe instruction block current status. RCP status codes: <ul style="list-style-type: none"> <li>• 0 Idle</li> <li>• 1 Doing</li> <li>• 2 Succeed, complete without error.</li> <li>• 3 Error, complete with error.</li> </ul>
ErrorID	Output	UDINT	The numeric RCP error code. The definitions are defined in RCP error codes.

### RCP error codes

Error code	Error Name
0	RCP_ERR_NONE
1	RCP_ERR_NO_SDCARD
2	RCP_ERR_DATAFILE_FULL
3	RCP_ERR_DATAFILE_ACCESS SD card are identified as: <ul style="list-style-type: none"> <li>• broken.</li> <li>• full.</li> <li>• read only.</li> </ul>
4	RCP_ERR_CFG_ABSENT
5	RCP_ERR_CFG_ID
6	RCP_ERR_RESOURCE_BUSY
7	RCP_ERR_CFG_FORMAT
8	RCP_ERR_RESERVED Reserved for future possible expansion.
9	RCP_ERR_UNKNOWN
10	RCP_ERR_DATAFILE_NAME
11	RCP_ERR_DATAFOLDER_INVALID
12	RCP_ERR_DATAFILE_ABSENT
13	RCP_ERR_DATAFILE_FORMAT
14	RCP_ERR_DATAFILE_SIZE Recipe data file size is too large (>4kb).

### RCP Function Block Diagram example

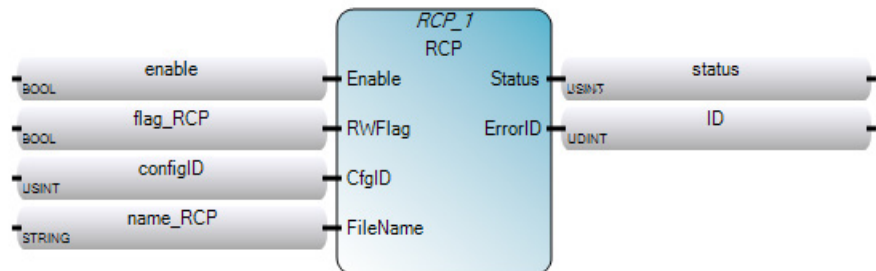



## RCP Ladder Diagram example

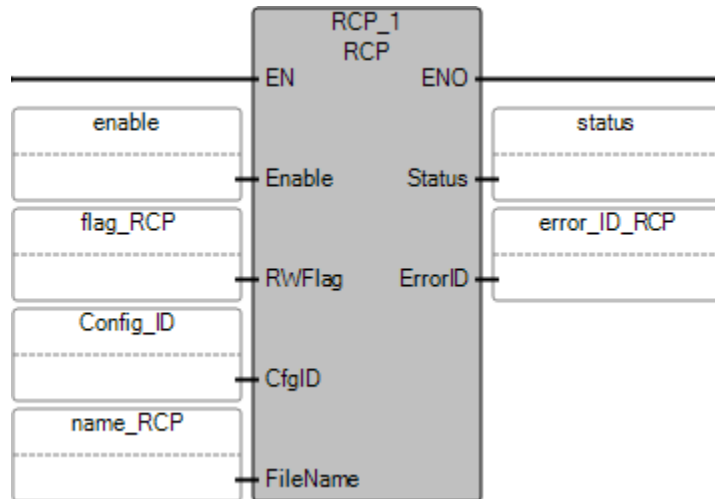

## RCP Structured Text example

```
RCP_1(
void RCP_1(BOOL Enable, BOOL RWFlag, USINT CfgID, STRING FileName)
Type : RCP, Save/Restore list of data to/from SD Card Recipe file.
```

```
1 RCP_1 (EN, Enable, RWFlag, CfgID, FileName);
2 output := RCP_1.ENO
3 status := RCP_1.Status
4 error_ID_RCP := RCP_1.ErrorID
```

## RTC\_READ ( read real-time clock)

Reads the real-time clock (RTC) module information.

Operation details:

- Micro810 or Micro820 controller with embedded RTC:
  - RTCBatLow is always set to zero (0).
  - RTCEnabled is always set to one (1).
- When the embedded RTC has lost its charge/memory due to loss of power:
  - RTCData is set to 2000/1/1/0/0/0.
  - RTCEnabled is set to one (1).

Languages supported: Function Block Diagram, Ladder Diagram, Structured Text.

This instruction applies to the Micro810, Micro820, Micro830, Micro850, Micro870 controllers and Micro800 Simulator.

The outputs are always reset when the instruction is applied to the simulated controller (2080-LC50-48QWB-SIM).

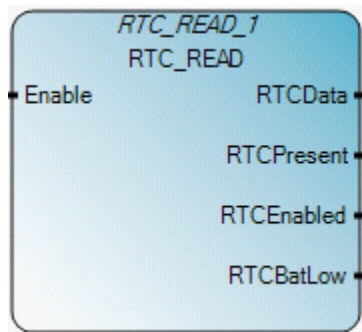

Use this table to help determine the parameter values for this instruction.

Parameter	Parameter Type	Data Type	Description
Enable	Input	BOOL	Instruction block enable. TRUE - execute RTC information read. FALSE - there is no read operation and output RTC data is invalid.
RTCDData	Output	RTC	RTC data information: yy/mm/dd, hh/mm/ss, week. RTCDData output is defined using the RTC data type.
RTCPresent	Output	BOOL	TRUE - Free Running clock is utilized, or RTC hardware is plugged in. FALSE - Free Running clock is not utilized, or RTC hardware is not plugged in.
RTCEnabled	Output	BOOL	TRUE - Free Running clock is utilized, or RTC hardware is enabled (timing). FALSE - Free Running clock is not utilized, RTC hardware is disabled (not timing).
RTCBatLow	Output	BOOL	TRUE - RTC battery is low. FALSE - RTC battery is not low.
ENO	Output	BOOL	Enable output. Applies only to Ladder Diagram programs.

### RTC data type

Use this table to help determine the parameter values for the RTC data type.

Parameter	Data type	Description
Year	UINT	The year setting for the RTC. 16-bit value, and the valid range is from 2000 (Jan 01, 00:00:00) to 2098 (Dec. 31, 23:59:59)
Month	UINT	The month setting for the RTC.
Day	UINT	The day setting for the RTC.
Hour	UINT	The hour setting for the RTC.
Minute	UINT	The minute setting for the RTC.
Second	UINT	The second setting for the RTC.
DayOfWeek	UINT	The day of the week setting for the RTC. This parameter is ignored for RTC_SET.

## RTC\_READ Function Block Diagram example

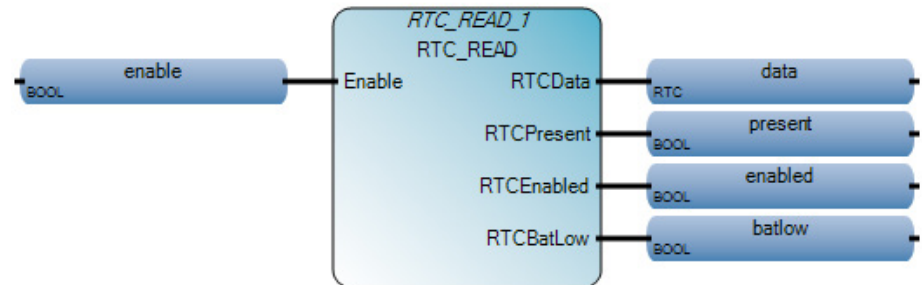

## RTC\_READ Ladder Diagram example

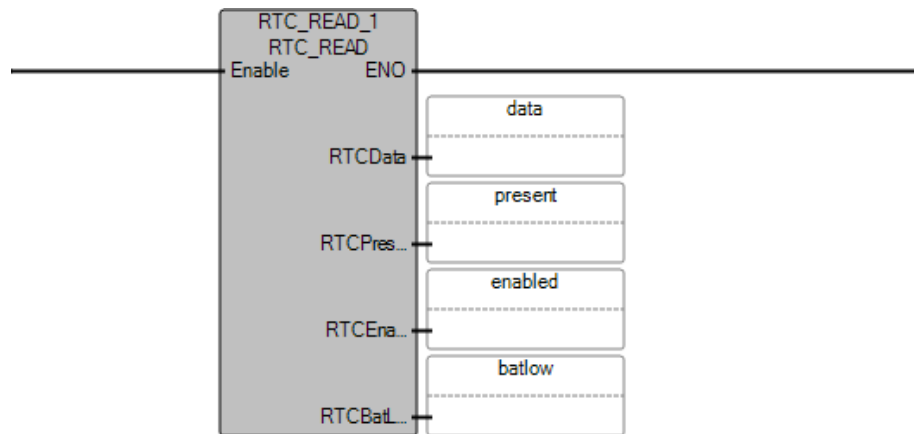

## RTC\_READ Structured Text example

```
RTC_READ_1 (
  void RTC_READ_1(BOOL Enable)
  Type : RTC_READ, Read RTC module information.
```

```
1 | RTC_READ_1(enable);
2 | data := RTC_READ_1.RTCData;
3 | present := RTC_READ_1.RTCPresent;
4 | enabled := RTC_READ_1.RTCEnabled;
5 | batlow := RTC_READ_1.RTCBatLow;
```

## RTC\_SET (set real-time clock)

Set RTC (real-time clock) data to the RTC module information.

Languages supported: Function Block Diagram, Ladder Diagram, Structured Text.

This instruction applies to the Micro810, Micro820, Micro830, Micro850, Micro870 controllers and Micro800 Simulator.

The outputs are always reset when the instruction is applied to the simulated controller (2080-LC50-48QWB-SIM).

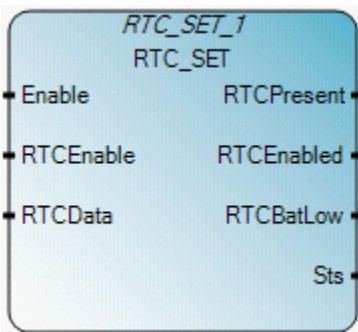

Use this table to help determine the parameter values for this instruction.

Parameter	Parameter Type	Data Type	Description
Enable	Input	BOOL	Instruction block enable. TRUE - execute RTC.SET with the RTC information from input. Typically, only execute for 1 program scan when updating the RTC. FALSE - do not execute RTC.SET. Set to FALSE to operate RTC normally.
RTCEnable	Input	BOOL	TRUE - To enable RTC with the RTC data specified. FALSE - To disable RTC.
RTCData	Input	RTC	RTC data information: yy/mm/dd, hh/mm/ss, week as defined in the RTC data type. RTCData is ignored when RTCEnable = 0.
RTCPresent	Output	BOOL	TRUE - Free Running clock is utilized, or RTC hardware is plugged in. FALSE - Free Running clock is not utilized, or RTC hardware is not plugged in.
RTCEnable	Output	BOOL	TRUE - Free Running clock is utilized, or RTC hardware is enabled (timing). FALSE - Free Running clock is not utilized, or RTC hardware is disabled (not timing).
RTCBatLow	Output	BOOL	TRUE - RTC battery is low. FALSE - RTC battery is not low.
Sts	Output	USINT	The read operation status. RTC_Set status (Sts) values: <ul style="list-style-type: none"> <li>• 0x00 - Function block not enabled (no operation).</li> <li>• 0x01 - RTC set operation success.</li> <li>• 0x02 - RTC set operation fails.</li> </ul>

### RTC data type

Use this table to help determine the parameter values for the RTC data type.

Parameter	Data type	Description
Year	UINT	The year setting for the RTC. 16-bit value, and the valid range is from 2000 (Jan 01, 00:00:00) to 2098 (Dec. 31, 23:59:59)
Month	UINT	The month setting for the RTC.
Day	UINT	The day setting for the RTC.
Hour	UINT	The hour setting for the RTC.
Minute	UINT	The minute setting for the RTC.
Second	UINT	The second setting for the RTC.
DayOfWeek	UINT	The day of the week setting for the RTC. This parameter is ignored for RTC.SET.

### RTC\_SET Function Block Diagram example

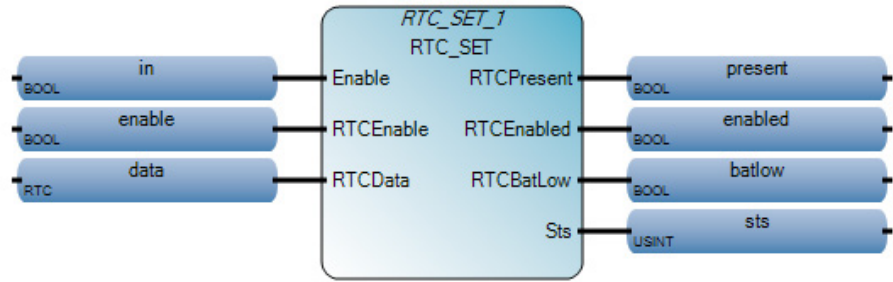

### RTC\_SET Ladder Diagram example

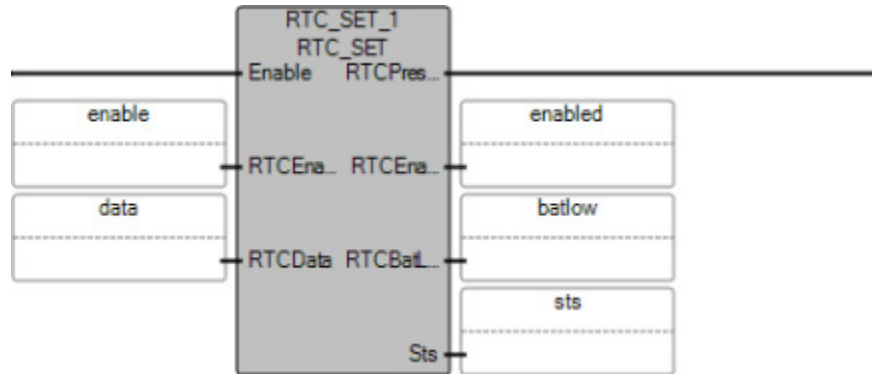

### RTC\_SET Structured Text example

```

RTC_SET_1(
void RTC_SET_1(BOOL Enable, BOOL RTCEnable, RTC RTCData)
Type : RTC_SET, Set RTC data to RTC module.

1 | RTC_SET_1(in, enable, data);
2 | present := RTC_SET_1.RTCPresent;
3 | enabled := RTC_SET_1.RTCEnable;
4 | batlow := RTC_SET_1.RTCBatLow;
5 | sts := RTC_SET_1.Sts;

```

## SYS\_INFO

Reads the status data block for the Micro800 controller.

Languages supported: Function Block Diagram, Ladder Diagram, Structured Text.

This instruction applies to the Micro810, Micro820, Micro830, Micro850, Micro870 controllers and Micro800 Simulator.

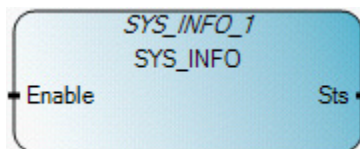

Use this table to help determine the parameter values for this instruction.

Parameter	Parameter Type	Data Type	Description
-----------	----------------	-----------	-------------

Enable	Input	BOOL	Instruction block enable. TRUE - execute read operation. FALSE - do not execute function.
Sts	Output	SYSINFO	System status data block. The Sts output is defined in the <a href="#">SYS_INFO data type</a> on <a href="#">page 391</a> .
ENO	Output	BOOL	Enable output. Applies only to Ladder Diagram programs.

### SYS\_INFO Function Block Diagram example

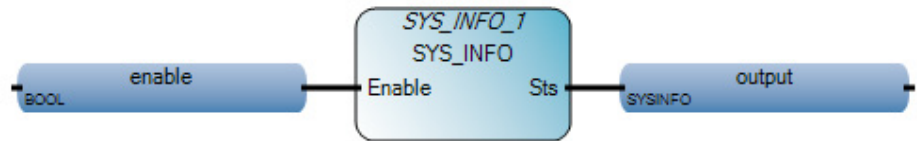

### SYS\_INFO Ladder Diagram example

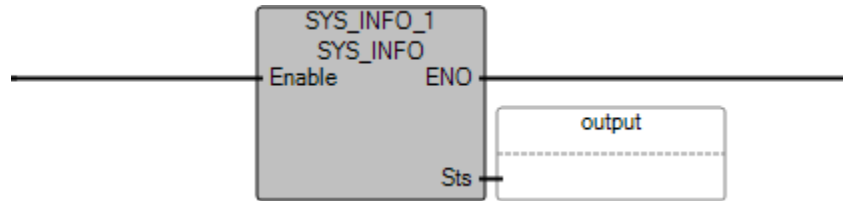

### SYS\_INFO Structured Text example

```

SYS_INFO_1(
void SYS_INFO_1(BOOL Enable)
Type : SYS_INFO, Read Micro800 system status.

1 | SYS_INFO_1(enable);
2 | output := SYS_INFO_1.Sts;

```

## Results

The screenshot shows the 'Variable Monitoring' window with the following data:

Name	Logical Value	Physical Value	Initial Value	Lock	Data Type
enable	<input checked="" type="checkbox"/>	N/A		<input type="checkbox"/>	BOOL
output	...	...	...	<input type="checkbox"/>	SYSINFO
output.BootMajRev	3	N/A		<input type="checkbox"/>	UINT
output.BootMinRev	4	N/A		<input type="checkbox"/>	UINT
output.OSSeries	0	N/A		<input type="checkbox"/>	UINT
output.OSMajRev	12	N/A		<input type="checkbox"/>	UINT
output.OSMinRev	11	N/A		<input type="checkbox"/>	UINT
output.ModeBehavio	<input type="checkbox"/>	N/A		<input type="checkbox"/>	BOOL
output.FaultOverrid	<input type="checkbox"/>	N/A		<input type="checkbox"/>	BOOL
output.StrtUpProtect	<input type="checkbox"/>	N/A		<input type="checkbox"/>	BOOL
output.MajErrHalted	<input type="checkbox"/>	N/A		<input type="checkbox"/>	BOOL
output.MajErrCode	0	N/A		<input type="checkbox"/>	UINT
output.MajErrUFR	<input type="checkbox"/>	N/A		<input type="checkbox"/>	BOOL
output.UFRPouNum	0	N/A		<input type="checkbox"/>	UINT
output.MMLoadAlwa	<input type="checkbox"/>	N/A		<input type="checkbox"/>	BOOL
output.MMLoadOnE	<input type="checkbox"/>	N/A		<input type="checkbox"/>	BOOL
output.MMPwdMism	<input type="checkbox"/>	N/A		<input type="checkbox"/>	BOOL
output.FreeRunCloc	6726	N/A		<input type="checkbox"/>	UINT
output.ForcesInstall	<input type="checkbox"/>	N/A		<input type="checkbox"/>	BOOL
output.EmlnFilterMc	<input type="checkbox"/>	N/A		<input type="checkbox"/>	BOOL
SYS_INFO_1	...	...	...	<input type="checkbox"/>	SYS_INFO

### SYS\_INFO data type

The following table describes the SYSINFO data type.

Parameter	Data type	Description
BootMajRev	UINT	Boot Major Revision.
BootMinRev	UINT	Boot Minor Revision.
Operating System Series	UINT	Operating System Series: 0 indicates a series A device 1 indicates a series B device
OSMajRev	UINT	OS Major Revision.
OSMinRev	UINT	OS Minor Revision.
ModeBehaviour	BOOL	Mode Behavior (TRUE: Go to RUN on power up).
FaultOverride	BOOL	Fault Override (TRUE: Override error on power up).
StrtUpProtect	BOOL	Startup Protection (TRUE: Run startup protection program on power up). For future release.
MajErrHalted	BOOL	Major error halted (TRUE: Major error halted).
MajErrCode	UINT	Major error code.
MajErrUFR	BOOL	Major error during user fault routine. For future release.
UFRPouNum	UINT	User fault routine program number.

Parameter	Data type	Description
MMLoadAlways	BOOL	Memory Module restore to controller always on power up (TRUE: Restore).
MMLoadOnError	BOOL	Memory Module restore to controller if power up with error (TRUE: Restore).
MMPwdMismatch	BOOL	Memory Module password mismatch (TRUE: Controller and Memory Module password mismatch).
FreeRunClock	UINT	Free running clock that increments every 100 microseconds from 0 to 65535 and then returns to 0. You can use the Clock, which is globally accessible, if you need more resolution than the standard 1 millisecond timer. Only supported for Micro830 and Micro850 controllers. Value for Micro810 controllers remains 0.
ForcesInstall	BOOL	Forces enabled (TRUE: Enabled).
EMINFilterMod	BOOL	Embedded filter modified (TRUE: Modified).

## TRIMPOT\_READ (read trimpot)

Reads the trimpot value from a specific trimpot.

Languages supported: Function Block Diagram, Ladder Diagram, Structured Text.

This instruction applies to the Micro820, Micro830, Micro850, and Micro870 controllers.

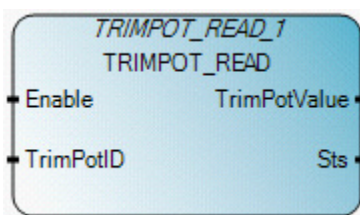

Use this table to help determine the parameter values for this instruction.

Parameter	Parameter Type	Data Type	Description
Enable	Input	BOOL	Instruction block enable. TRUE - execute Trimpot read. FALSE - there is no read operation and output Trimpot value is invalid.
TrimPotID	Input	UINT	The ID of the Trimpot to be read. TrimPotID is defined in <a href="#">Trimpot ID definitions</a> on <a href="#">page 393</a> .
TrimPotValue	Output	UINT	Current trimpot value.
Sts	Output	UINT	The Trimpot read operation status. TRIMPOT status (Sts) codes: <ul style="list-style-type: none"> <li>• 0x00 - Function block not enabled (no read/write operation).</li> <li>• 0x01 - Read/write operation success.</li> <li>• 0x02 - Read/write operation fails due to an invalid Trimpot ID.</li> <li>• 0x03 - Write operation fails due to an out of range value.</li> </ul>
ENO	Output	BOOL	Enable output. Applies only to Ladder Diagram programs.



### TRIMPOT Function Block Diagram example

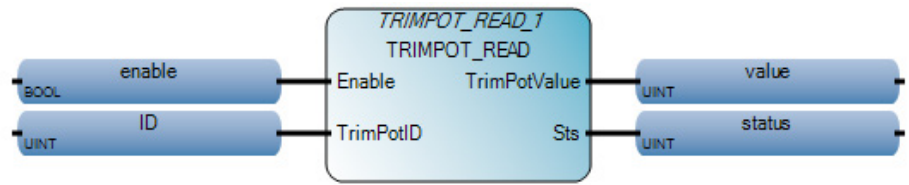

### TRIMPOT Ladder Diagram example

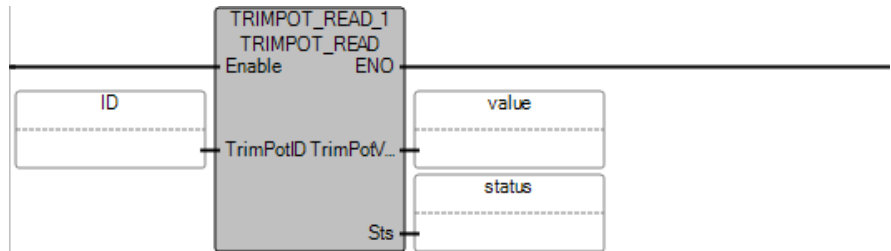

### TRIMPOT Structured Text example

```

TRIMPOT_READ_1(
void TRIMPOT_READ_1(BOOL Enable, UINT TrimPotID)
Type : TRIMPOT_READ, Read the Trimpot value from a specific Trimpot.

1 TRIMPOT_READ_1(enable, ID);
2 value := TRIMPOT_READ_1.TrimPotValue;
3 status := TRIMPOT_READ_1.Sts;

```

### Trimpot ID definition

The following table describes the Trimpot ID definition used in the [TRIMPOT read instruction](#) on [page 392](#).

Output selection	Bit	Description
Trimpot ID definition	15 - 13	Module type of trimpot: <ul style="list-style-type: none"> <li>• 0x00 - Embedded.</li> <li>• 0x01 - Expansion.</li> <li>• 0x02 - Plug-in Port.</li> </ul>
	12 - 8	Slot ID of the module: <ul style="list-style-type: none"> <li>• 0x00 - Embedded.</li> <li>• 0x01-0x1F - ID of Expansion Module.</li> <li>• 0x01-0x05 - ID of Plug-in Port.</li> </ul>
	7 - 4	Trimpot type: <ul style="list-style-type: none"> <li>• 0x00 - Reserved.</li> <li>• 0x01 - Digital Trimpot Type 1(LCD Module 1).</li> <li>• 0x02 - Mechanical Trimpot Module 1.</li> </ul>

<b>Output selection</b>	<b>Bit</b>	<b>Description</b>
	3 - 0	Trimpot ID inside the module: <ul style="list-style-type: none"><li>● 0x00-0x0F - Embedded.</li><li>● 0x00-0x07 - ID of Trimpot for Expansion.</li><li>● 0x00-0x07 - ID of Trimpot for Plug-in Port.</li></ul> The trimpot ID starts from 0.

## Interrupt instructions

Use Interrupt instructions to signal the processor that an event needs attention. Usually the interrupt signal is used for high-priority conditions that require interruption of the current code the processor is executing.

Function	Description
<a href="#">STIS on page 395</a>	Starts the selected timed user interrupt (STI ) timer from the control program rather than starting automatically.
<a href="#">UIC on page 397</a>	Clears the lost bit for the selected user interrupt.
<a href="#">UID on page 398</a>	Disables a specific user interrupt.
<a href="#">UIE on page 400</a>	Enables a specific user input.
<a href="#">UIF on page 402</a>	Flushes or removes a pending user input.

### STIS (select timed start)

Starts the selectable timed user interrupt (STI ) timer from the control program rather than starting automatically.

Languages supported: Function Block Diagram, Ladder Diagram, Structured Text.

This instruction applies to the Micro820, Micro830, Micro850, Micro870 controllers and Micro800 Simulator.

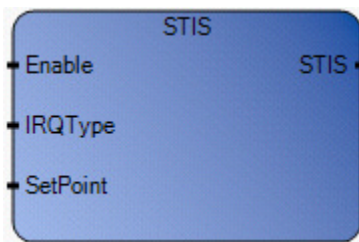

Use this table to help determine the parameter values for this instruction.

Parameter	Parameter Type	Data Type	Description
Enable	Input	BOOL	Instruction enable. TRUE - start the STI timer from the control program. FALSE - do not perform function.
IRQType	Input	UDINT	Use the STI defined words. - IRQ_STI0 - IRQ_STI1 - IRQ_STI2 - IRQ_STI3
SetPoint	Input	UINT	The amount of time (in ms) which must expire prior to executing the selectable timed interrupt. A value of 0 disables the STIS function. A value between 1 and 65535 enables the STIS function.

STIS	Output	BOOL	Rung status (same as Enable).
------	--------	------	-------------------------------

### STIS Function Block Diagram example

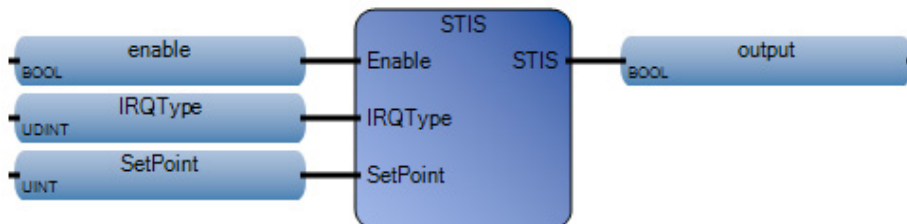

### STIS Ladder Diagram example

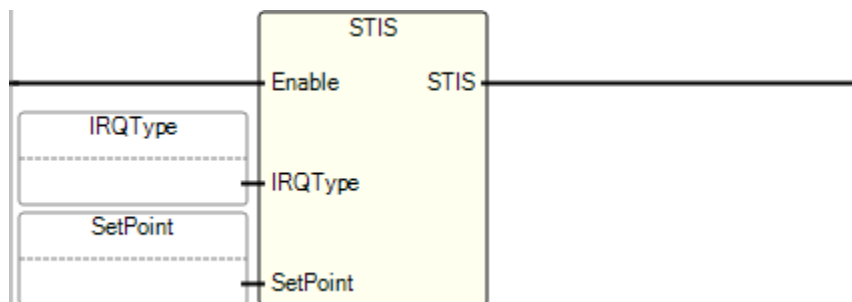

### STIS Structured Text example

```

STIS (
  BOOL STIS(BOOL Enable, UDINT IRQType, UINT SetPoint)
  Start STI timer from control program(instead of automatically).

1  enable := TRUE;
2  IRQType := IRQ_STI2;
3  SetPoint := 1000;
4  output := STIS(enable, IRQType, SetPoint);

(* ST Equivalence: *)

TESTOUTPUT := STIS(TESTENABLE, 2, 1000);

```

## Results

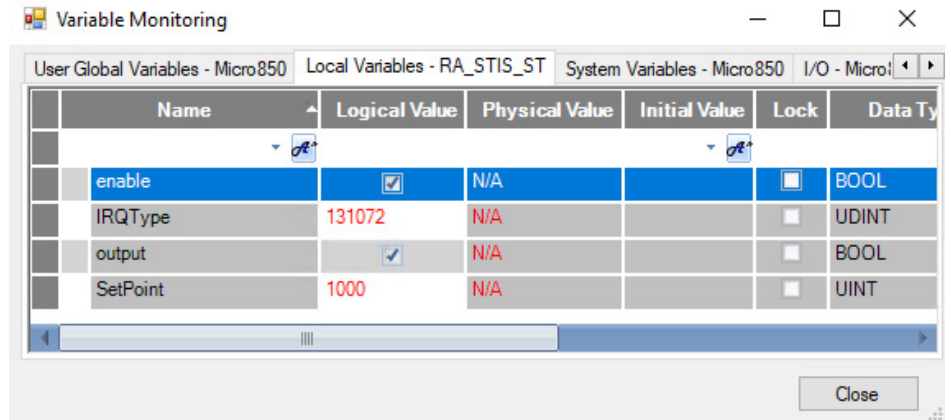

**UIC (clear interrupt lost bit)** Clears the lost bit for the selected user interrupt(s).

Languages supported: Function Block Diagram, Ladder Diagram, Structured Text.

This instruction applies to the Micro820, Micro830, Micro850, Micro870 controllers and Micro800 Simulator.

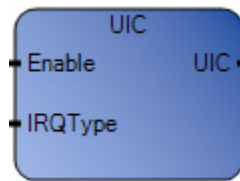

Use this table to help determine the parameter values for this instruction.

Parameter	Parameter Type	Data Type	Description
Enable	Input	BOOL	Instruction enable. TRUE - start clear bit operation. FALSE - do not perform function.
IRQType	Input	UDINT	Use the STI defined words. - IRQ_HSC3 - IRQ_HSC4 - IRQ_HSC5 - IRQ_STI0 - IRQ_STI1 - IRQ_STI2 - IRQ_STI3 - IRQ_UFR - IRQ_UPM0 - IRQ_UPM1 - IRQ_UPM2 - IRQ_UPM3 - IRQ_UPM4
UIC	Output	BOOL	Rung status (same as Enable).

### UIC Function Block Diagram example

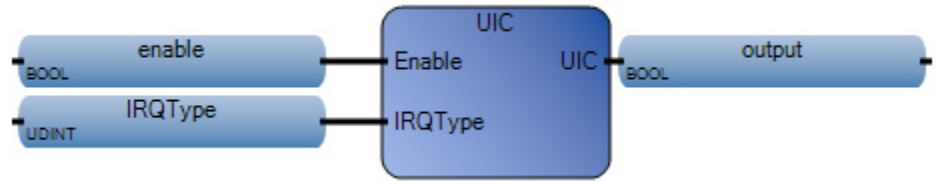

### UIC Ladder Diagram example

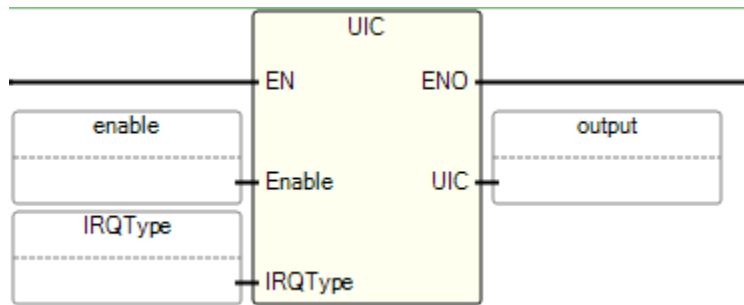

### UIC Structure Text example

```

1  enable := TRUE;
2  IRQType := 2;
3  output := UIC (enable, IRQType);

```

### Results

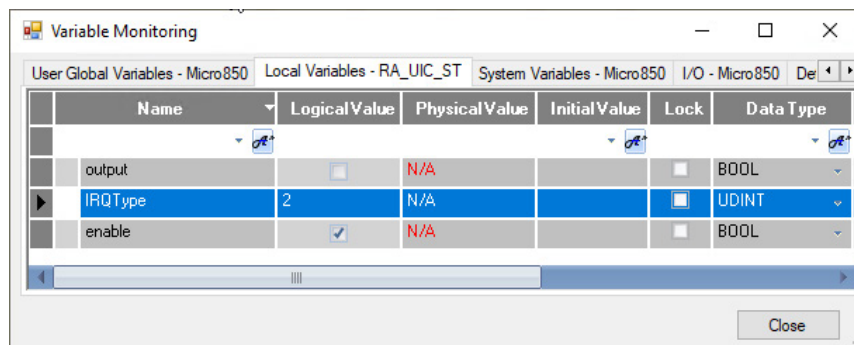

### UID (disable interrupt)

Disables a specific user interrupt(s).

Languages supported: Function Block Diagram, Ladder Diagram, Structured Text.

This instruction applies to the Micro820, Micro830, Micro850, Micro870 controllers and Micro800 Simulator.

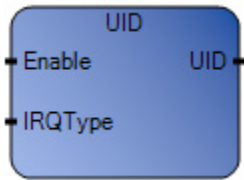

Use this table to help determine the parameter values for this instruction.

Parameter	Parameter Type	Data Type	Description
Enable	Input	BOOL	Instruction enable. TRUE - start the disable operation. FALSE - do not perform function.
IRQType	Input	UDINT	Use the ST1 defined words. - IRQ_EI10 - IRQ_EI11 - IRQ_EI12 - IRQ_EI13 - IRQ_EI14 - IRQ_EI15 - IRQ_EI16 - IRQ_EI17 - IRQ_HSC0 - IRQ_HSC1 - IRQ_HSC2 - IRQ_HSC3 - IRQ_HSC4 - IRQ_HSC5 - IRQ_ST10 - IRQ_ST11 - IRQ_ST12 - IRQ_ST13 - IRQ_UFR - IRQ_UPM0 - IRQ_UPM1 - IRQ_UPM2 - IRQ_UPM3 - IRQ_UPM4
UID	Output	BOOL	Rung status (same as Enable).

### UID Function Block Diagram example

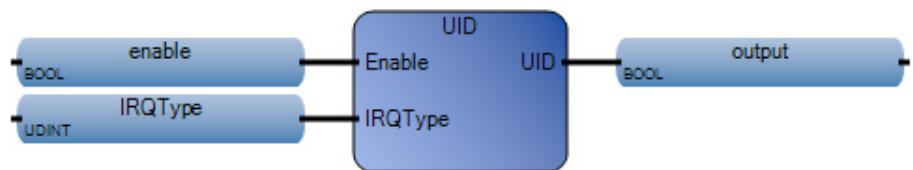

### UID Ladder Diagram example

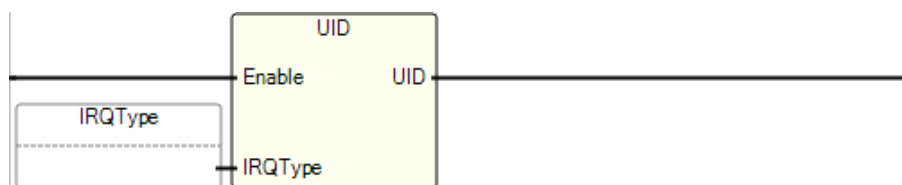

### UID Structured Text example

```
UID (
  BOOL UID(BOOL Enable, UDINT IRQType)
  Disable specific user interrupt.
```

```
1 enable := TRUE;
2 IRQType := 2;
3 output := UID(enable, IRQType);
```

(\* ST Equivalence: \*)

```
TESTOUTPUT := UID(TESTENABLE, 2);
```

### Results

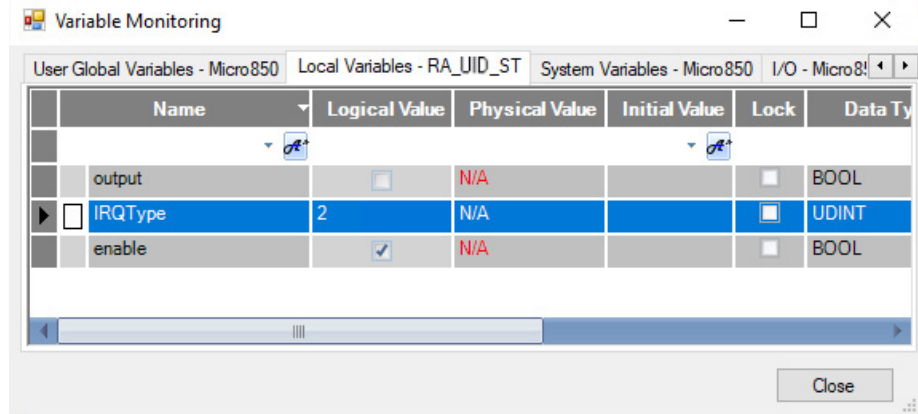

### UIE (enable interrupt)

Enables a specific user interrupt.

Languages supported: Function Block Diagram, Ladder Diagram, Structured Text.

This instruction applies to the Micro820, Micro830, Micro850, Micro870 controllers and Micro800 Simulator.

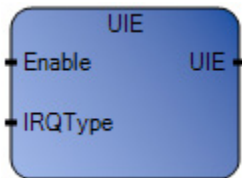

Use this table to help determine the parameter values for this instruction.

Parameter	Parameter Type	Data Type	Description
Enable	Input	BOOL	Instruction enable. TRUE - start enable operation. FALSE - do not perform function.



IRQType	Input	UDINT	Use the STI defined words. - IRQ_EI10 - IRQ_EI11 - IRQ_EI12 - IRQ_EI13 - IRQ_EI14 - IRQ_EI15 - IRQ_EI16 - IRQ_EI17 - IRQ_HSC0 - IRQ_HSC1 - IRQ_HSC2	- IRQ_HSC3 - IRQ_HSC4 - IRQ_HSC5 - IRQ_ST10 - IRQ_ST11 - IRQ_ST12 - IRQ_ST13 - IRQ_UFR - IRQ_UPM0 - IRQ_UPM1 - IRQ_UPM2 - IRQ_UPM3 - IRQ_UPM4
UIE	Output	BOOL	Rung status (same as Enable).	

### UIE Function Block Diagram example

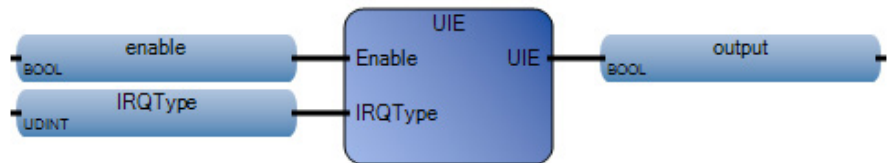

### UIE Ladder Diagram example

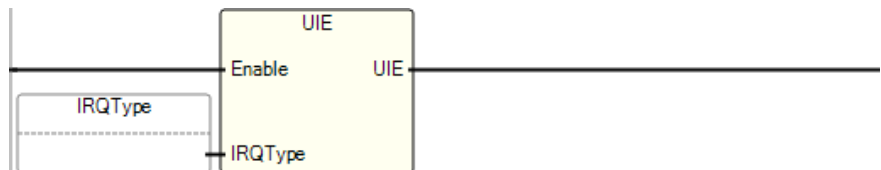

### UIE Structured Text example

```

UIE {
  BOOL UIE(BOOL Enable, UDINT IRQType)
  Enable specific user interrupt.

  1 enable := TRUE;
  2 IRQType := 2;
  3 output := UIE(enable, IRQType);

```

(\* ST Equivalence: \*)

```

TESTOUTPUT := UIE(TESTENABLE, 2);

```

## Results

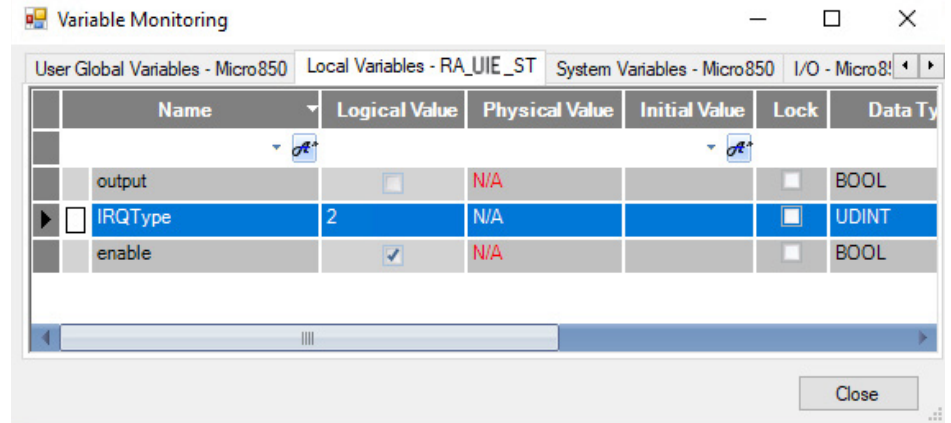

## UIF (flush pending interrupt)

Flushes or removes a pending user interrupt.

Languages supported: Function Block Diagram, Ladder Diagram, Structured Text.

This instruction applies to the Micro820, Micro830, Micro850, Micro870 controllers and Micro800 Simulator.

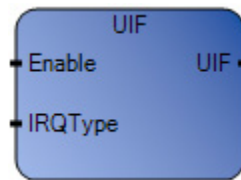

Use this table to help determine the parameter values for this instruction.

Parameter	Parameter Type	Data Type	Description
Enable	Input	BOOL	Instruction enable. TRUE - start UIF operation. FALSE - do not perform function.
IRQType	Input	UDINT	Use the ST1 defined words. - IRQ_EI10 - IRQ_EI11 - IRQ_EI12 - IRQ_EI13 - IRQ_EI14 - IRQ_EI15 - IRQ_EI16 - IRQ_EI17 - IRQ_HSC0 - IRQ_HSC1 - IRQ_HSC2 - IRQ_HSC3 - IRQ_HSC4 - IRQ_HSC5 - IRQ_ST10 - IRQ_ST11 - IRQ_ST12 - IRQ_ST13 - IRQ_UFR - IRQ_UPM0 - IRQ_UPM1 - IRQ_UPM2 - IRQ_UPM3 - IRQ_UPM4
UIF	Output	BOOL	Rung status (same as Enable).

### UIF Function Block Diagram example

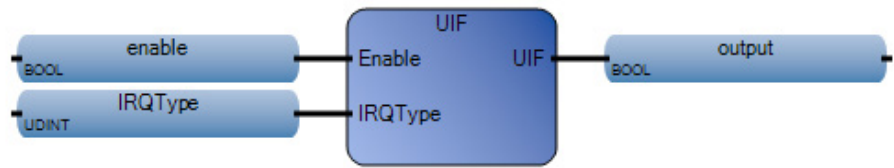

### UIF Ladder Diagram example

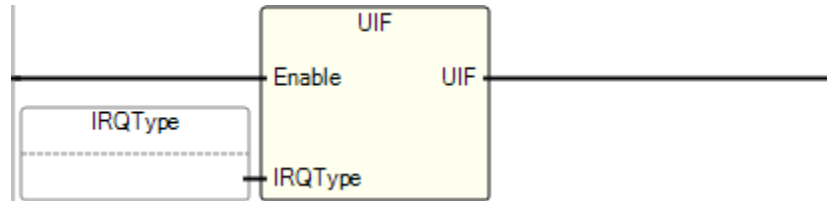

### UIF Structured Text example

```

UIF (
  BOOL UIF(BOOL Enable, UDINT IRQType)
  Flush specific user interrupt.

1  enable := TRUE;
2  IRQType := 2;
3  output := UIF(enable, IRQType);
  
```

(\* ST Equivalence: \*)

TESTOUTPUT := UIF(TESTENABLE, 2);

### Results

Name	Logical Value	Physical Value	Initial Value	Lock	Data Type
enable	<input checked="" type="checkbox"/>	N/A		<input type="checkbox"/>	BOOL
IRQType	2	N/A		<input type="checkbox"/>	UDINT
output	<input type="checkbox"/>	N/A		<input type="checkbox"/>	BOOL



## Motion control instructions

Use the motion control instructions to program and design the motion of a particular axis. Motion control requires Connected Components Workbench 2.0 or higher.



Tip:

- Administrative instructions support both PTO motion and Feedback motion.
- The motion control instructions that support an FBAxis are: MC\_ReadActualPosition and MC\_ReadActualVelocity.

Instruction	Description
<i>Administrative</i>	
<a href="#">MC_AbortTrigger</a> on <a href="#">page 415</a>	Cancells Motion function blocks that are connected to trigger events.
<a href="#">MC_Power</a> on <a href="#">page 436</a>	Control the power stage, ON or OFF.
<a href="#">MC_ReadAxisError</a> on <a href="#">page 447</a>	Reads the axis errors not related to the Motion control instruction blocks.
<a href="#">MC_ReadBoolParameter</a> on <a href="#">page 451</a>	Returns the value of a vendor specific parameter of type BOOL.
<a href="#">MC_ReadParameter</a> on <a href="#">page 454</a>	Returns the value of a vendor specific parameter of type Real.
<a href="#">MC_ReadStatus</a> on <a href="#">page 456</a>	Returns the status of the axis with respect to the motion currently in progress.
<a href="#">MC_Reset</a> on <a href="#">page 461</a>	Transitions the axis state from ErrorStop to StandStill by resetting all internal axis-related errors.
<a href="#">MC_SetPosition</a> on <a href="#">page 463</a>	Shifts the coordinate system of an axis by manipulating the actual position.
<a href="#">MC_TouchProbe</a> on <a href="#">page 470</a>	Records an axis position at a trigger event.
<a href="#">MC_WriteBoolParameter</a> on <a href="#">page 473</a>	Modifies the value of a vendor specific parameter of type BOOL.
<a href="#">MC_WriteParameter</a> on <a href="#">page 475</a>	Modifies the value of a vendor specific parameter of type REAL.
<i>Motion</i>	
<a href="#">MC_Halt</a> on <a href="#">page 418</a>	Commands a controlled motion stop under normal operating conditions.
<a href="#">MC_Home</a> on <a href="#">page 421</a>	Commands the axis to perform the <search home> sequence.
<a href="#">MC_MoveAbsolute</a> on <a href="#">page 424</a>	Commands a controlled motion to a specified absolute position.
<a href="#">MC_MoveRelative</a> on <a href="#">page 428</a>	Commands a controlled motion of a specified distance relative to the actual position at the time of the execution.
<a href="#">MC_MoveVelocity</a> on <a href="#">page 432</a>	Commands a never ending controlled motion at a specified velocity.
<a href="#">MC_ReadActualPosition</a> on <a href="#">page 440</a>	Returns the actual position of the feedback axis. Requires Connected Components Workbench 8 or higher.
<a href="#">MC_ReadActualVelocity</a> on <a href="#">page 444</a>	Returns the actual velocity of the feedback axis. Requires Connected Components Workbench 8 or higher.
<a href="#">MC_Stop</a> on <a href="#">page 466</a>	Commands a controlled motion stop and transfers the axis state to Stopping.

### General rules for motion control function blocks

The general rules for the Micro800 [motion control function blocks](#) on [page 405](#) follow the PLCopen Motion control specifications. The following table

provides general rules about the interface of motion control function blocks.

Rule applies to	Rule
Input parameters	<p><b>With Execute:</b> The parameters are used with the rising edge of the execute input. To modify any parameter, change the input parameter(s) and trigger the motion again.</p> <p>If an instance of a function block receives a new Execute before it finishes (as a series of commands on the same instance), the new Execute is ignored, and the previously issued instruction continues with its execution.</p> <p><b>With Enable:</b> The parameters are used with the rising edge of the enable input and can be modified continuously.</p>
Missing input parameters	<p>Missing input is captured during User Application compilation. There is no missing input error handling at the controller level.</p>
Inputs exceeding application limits	<p>If a function block is commanded with parameters that result in a violation of application limits, the instance of the function block generates an error. In this case, the Error output is flagged On, and error information is indicated by the output ErrorID. The controller, in most cases, remains in Run mode, and there is no Motion Error reported as a major controller fault.</p>
Sign rules for inputs	<p>The Acceleration, Deceleration, and Jerk inputs are always positive values. Velocity, Position and Distance inputs can have positive and negative values.</p>
Position versus Distance	<p>Position is a value defined within a coordinate system. Distance is a relative measure related to technical units. Distance is the difference between two positions.</p>
Position/Distance input	<p>Only linear motion is supported on Micro800 controllers. For MC_MoveAbsolute function block, the position input is the absolute location to be commanded to the axis. For MC_MoveRelative, the distance input is the relative location (considering current axis position is 0) from current position.</p>
Velocity input	<p>Velocity can be a signed value, but it can also use Direction input to define the sign of the velocity (negative velocity x negative direction = positive velocity). The E parameter "Direction" refers to the velocity input and output for compatibility reasons.</p>
Direction input	<p>For distance (position) motion, with the target position (either absolute, or relative) defined, the motion direction is unique. The direction input for distance move is ignored.</p> <p>For velocity motion, direction input value can be 1 (positive direction), 0 (current direction) or -1 (negative direction). For any other value, only the sign is considered. For example, -3 denotes negative direction, +2 denotes positive direction, and so on.</p> <p>For velocity move (MC_MoveVelocity), the sign (velocity x direction) determines the actual motion direction if the value is not 0. For example, if velocity x direction = +300, then direction is positive.</p>
Acceleration, Deceleration and Jerk inputs	<ul style="list-style-type: none"> <li>• Deceleration or Acceleration inputs should have a positive value. If Deceleration or Acceleration is set to a non-positive value, the function block reports an error (Error ID: MC_FB_ERR_RANGE).</li> <li>• Jerk input should have a non-negative value. If Jerk is set to a negative value, the function block reports an error (Error ID: MC_FB_ERR_RANGE).</li> <li>• If Maximum Jerk is set to zero, all jerk parameters for the motion control function block, including jerk setting for MC_Stop have to be set to zero. If they are not, the function block reports an error (Error ID: MC_FB_ERR_RANGE).</li> <li>• If Jerk is set to a non-zero value, S-Curve profile is generated; if Jerk is set to 0, trapezoidal profile is generated.</li> <li>• Home Jerk configuration is not limited to Max Jerk configuration.</li> <li>• If the motion engine fails to generate the motion profile prescribed by the dynamic input parameters, the function block reports an error (Error ID: MC_FB_ERR_PROFILE).</li> </ul>

Rule applies to	Rule
Output exclusivity	<p><b>With Execute:</b> When Execute is TRUE, one of the Busy, Done, Error, or CommandAborted outputs must also be TRUE. The outputs are mutually exclusive: only one output on one function block can be TRUE. Only one of the outputs Active, Error, Done and CommandAborted is set at one time.</p> <p><b>With Enable:</b> The Valid and Error outputs are mutually exclusive: only one output on one function block can be TRUE.</p>
Output status	<p><b>With Execute:</b> The Done, Error, ErrorID and CommandAborted outputs are reset with the falling edge of Execute instruction. However, the falling edge of Execute does not stop or influence the execution of the actual function block. Even if Execute is reset before the function block completes, the corresponding outputs are set for at least one cycle. If an instance of a function block receives a new Execute command before it completes (as a series of commands on the same instance), the new Execute command is ignored, and the previously issued instruction continues with execution.</p> <p><b>With Enable:</b> Valid, Enabled, Busy, Error, and ErrorID outputs are reset with the falling edge of Enable as soon as possible.</p>
Behavior of Done output	<p>The Done output is set when the commanded action has successfully completed.</p> <p>When multiple function blocks are working on the same axis in a sequence, the following applies:</p> <ul style="list-style-type: none"> <li>• When one movement on an axis is interrupted with another movement on the same axis without having reached the final goal, Done on the first function block will not be set.</li> </ul>
Behavior of Busy output	<p>Every function block can have a Busy output, indicating the function block is not finished (for function blocks with an Execute input) or is not working and new output values can be expected (in case of Enable input).</p> <p>Busy is set at the rising edge of Execute and reset when one of the outputs Done, Aborted, or Error is set. The function block should be kept in the active loop of the application program for at least as long as Busy is TRUE because the outputs may change.</p> <p>Function blocks with the same instance that are busy cannot execute until it is no longer busy. Function blocks with different instances can override the currently executing function block.</p>
Behavior of CommandAborted output	<p>The CommandAborted output is set when a commanded motion is interrupted by another motion command.</p> <p>The reset behavior of CommandAborted output is similar to Done output. When CommandAborted occurs, other output signals such as InVelocity are reset.</p>
Output Active	<p>The Active output is required on buffered function blocks, and is set at the moment the function block takes control of the motion of the according axis.</p> <p>For unbuffered mode, the Active and Busy outputs can have the same value.</p>
Enable and Valid status	<p>The Enable input is coupled to a Valid output. Enable is level sensitive, and Valid shows that a valid set of outputs is available at the function block.</p> <p>The Valid output is TRUE as long as a valid output value is available and the Enable input is TRUE. The relevant output value can be refreshed as long as the input Enable is TRUE.</p> <p>If there is a function block error, the output is not valid (Valid set to FALSE). When the error condition disappears, the values reappear and Valid output is set again.</p>
Output error handling	<p><b>Outputs used to define errors</b></p> <p>All blocks have the following two outputs that are used for errors that occur during execution:</p> <ul style="list-style-type: none"> <li>• Error – Rising edge of "Error" informs that an error occurred during the execution of the function block.</li> <li>• ErrorID – Error number.</li> </ul> <p>Done and InVelocity outputs are used for successful completion so they are logically exclusive to Error.</p> <p>Instance errors do not always result in an axis error (bringing the axis to ErrorStop).</p> <p><b>How the error outputs are reset</b></p> <ul style="list-style-type: none"> <li>• Error outputs of the relevant function blocks are reset with the falling edge of Execute and Enable.</li> <li>• The error outputs of a function block with Enable can be reset during operation without having to reset Enable.</li> </ul>

Rule applies to	Rule
	<p><b>Types of errors</b></p> <ul style="list-style-type: none"> <li>• Function blocks logics (for example, parameters out of range, state machine violation attempted, and so on)</li> <li>• HW Limit or SW Limit</li> <li>• Mechanism/Motor</li> <li>• Drive</li> </ul>
Naming conventions ENUM types	<p>Due to the naming constraints in the IEC standard on the uniqueness of variable names, the 'mc' reference to the PLCOpen Motion Control namespace is used for the ENUMs.</p> <p>In this way we avoid the conflict that using the ENUM types 'positive' and 'negative' for instance with variables with these names throughout the rest of the project since they are called mcPositive and mcNegative respectively.</p>

## Motion control function block parameter details

The following topics provide details for motion control parameters that are relevant to all motion control function blocks.

[Motion control axis states](#) on [page 408](#)

[Motion control function block parameter numbers](#) on [page 410](#)

[Motion control function block error IDs](#) on [page 411](#)

## Motion control axis states

The basic rule for the behavior of the axis at a high level when multiple motion control function blocks are activated is that motion commands are always taken sequentially, even if the controller has the capability of real parallel processing. Any motion command is a transition that changes the state of the axis and, as a consequence, modifies the way the current motion is computed.



### Motion control axis state diagram

The axis is always in one of the defined states as shown in the following diagram.

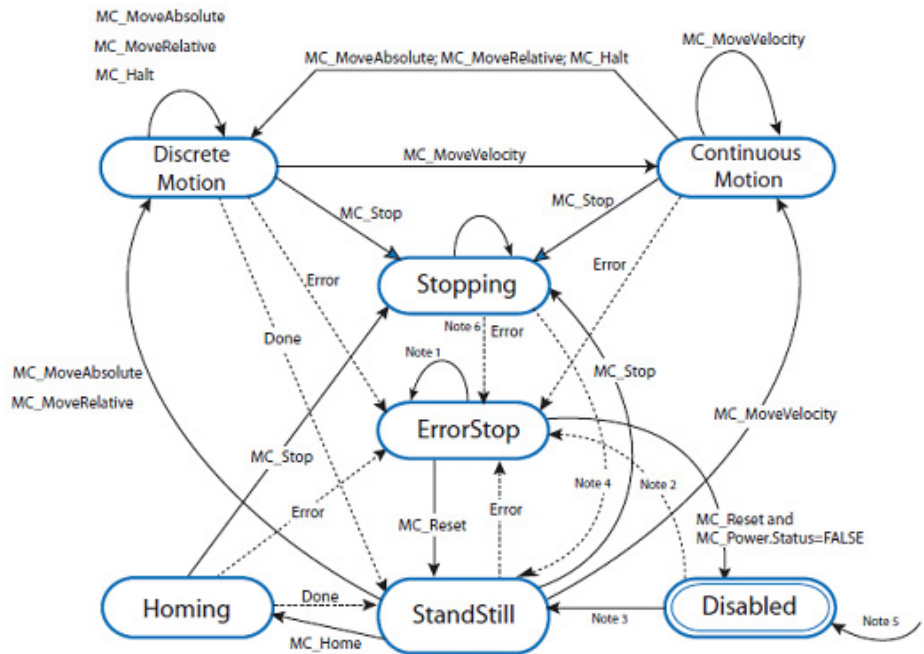

### Motion control axis state behavior

No	Note
1	In the ErrorStop and Stopping states, all function blocks (except MC_Reset), can be called although they will not be executed. MC_Reset generates a transition to the Standstill state. If an error occurs while the state machine is in the Stopping state, a transition to the ErrorStop state is generated.
2	Power.Enable = TRUE and there is an error in the axis.
3	Power.Enable = TRUE and there is no error in the axis
4	MC_Stop.Done AND NOT MC_Stop.Execute.
5	When MC_Power is called with Enable = False, the axis goes to the Disabled state for every state including ErrorStop.
6	If an error occurs while the state machine is in Stopping state, a transition to the ErrorStop state is generated.

### Motion control axis state code values

You can monitor the axis state using the Axis Monitor feature. The following table identifies the values used to define each of the predefined axis states.

State value	State name
0x00	Disabled
0x01	Standstill
0x02	Discrete Motion
0x03	Continuous Motion

0x04	Homing
0x06	Stopping
0x07	Error Stop

### Axis state updates

On motion execution, the axis state update is dependent on when the relevant motion function block is called by the POU scan. This is the case even though the motion profile is controlled by the Motion Engine as a background task, and is independent from the POU scan.

For example, on a moving axis on a Ladder POU (state of a rung=true), an MC\_MoveRelative function block in the rung is scanned and the axis starts to move. Before MC\_MoveRelative completes, the state of the rung becomes False, and MC\_MoveRelative is no longer scanned. In this case, the state of the axis cannot switch from Discrete Motion to StandStill, even after the axis fully stops, and the velocity comes to 0.

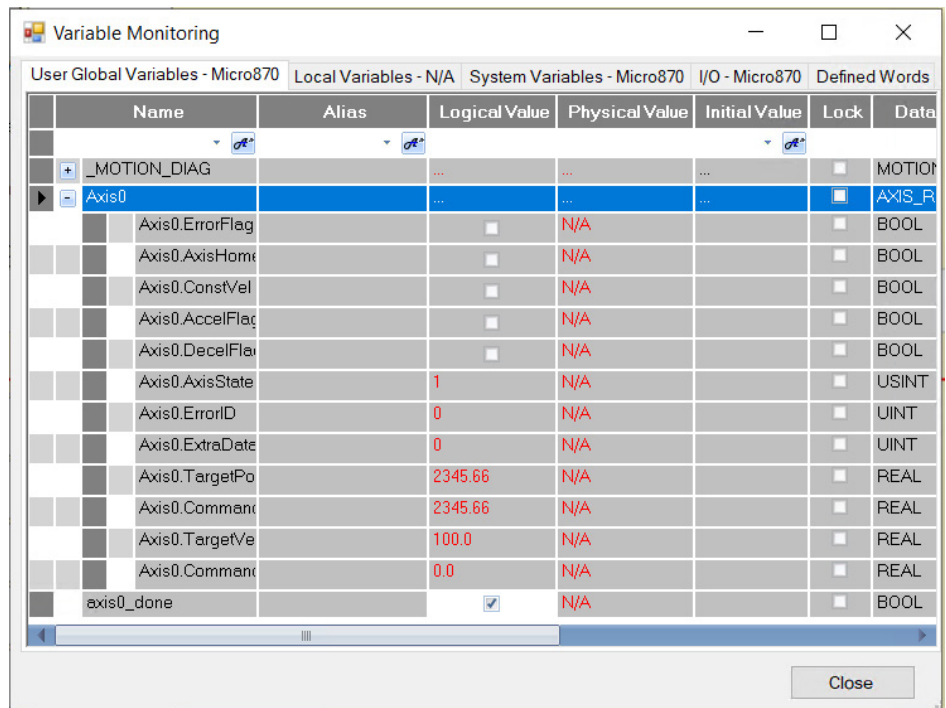

### Motion control function block parameter numbers

The following function blocks use specific parameter numbers when the function blocks are programmed.

- MC\_ReadParameter
- MC\_ReadBoolParameter
- MC\_WriteParameter
- MC\_WriteBoolParameter

## Parameter number identification

Parameter numbers between 0 and 999 are reserved for standard parameters. Extensions by a supplier or user are also allowed, although using them can affect portability between different platforms. If the parameter number is greater than 999, the parameter is supplier-specific.

Parameter number	Parameter Name	Data type	R/W	Description
1	Commanded Position	REAL	R	Commanded position.
2	SWLimitPos	REAL	R/W	Positive software limit switch position.
3	SWLimitNeg	REAL	R/W	Negative software limit switch position.
4	EnableLimitPos	BOOL	R/W	Enable positive software limit switch.
5	EnableLimitNeg	BOOL	R/W	Enable negative software limit switch.
8	MaxVelocitySystem	REAL	R	Maximal allowed velocity of the axis in the motion system.
9	MaxVelocityAppl	REAL	R/W	Maximal allowed velocity of the axis in the application.
11	CommandedVelocity	REAL	R	Commanded velocity.
12	MaxAccelerationSystem	REAL	R	Maximal allowed acceleration of the axis in the motion system.
13	MaxAccelerationAppl	REAL	R/W	Maximal allowed acceleration of the axis in the application.
14	MaxDecelerationSystem	REAL	R	Maximal allowed deceleration of the axis in the system.
15	MaxDecelerationAppl	REAL	R/W	Maximal allowed deceleration of the axis in the application.
16	MaxJerk	REAL	R/W	Maximal allowed jerk of the axis.
1001	TargetPosition	REAL	R	The final target position for current active moving function block
1002	TargetVelocity1	REAL	R	The final target velocity for current active moving function block.
1005	Duty Cycle	REAL	R/W	The pulse duty cycle for one pulse. The valid value is 0 - 100, indicating 0% - 100%. (PWM function can be realized by adjusting this value). This parameter is configurable only using this Function Block. The default value is set 50.0 by the controller. <b>Note:</b> For Duty Cycle, the value will be overwritten by the default setting, 50.0 when the controller is switched from RUN mode to PRG and RUN again, or when the controller power is cycled.
1006	PulsePerRevolution	REAL	R	The Pulse per Revolution setting input by user in CCW GUI.
1007	TravelPerRevolution	REAL	R	The Travel per Revolution setting input by user in CCW GUI.

## Motion control function block error IDs

When a motion control function block ends with an error and the axis state is ErrorStop, use MC\_Reset function block or MC\_Power Off/On and MC\_Reset to recover the axis. The axis can be reset to normal motion operation without stopping the controller operation.

Use this table to help determine the errors for the motion control function blocks.

Value	MACRO ID	Description
00	MC_FB_ERR_NO	The function block execution is successful.
01	MC_FB_ERR_WRONG_STATE	The function block cannot execute because the axis is not in the correct state. Check the <a href="#">axis state</a> on <a href="#">page 408</a> .

Value	MACRO ID	Description
02	MC_FB_ERR_RANGE	The function block cannot execute because there is invalid axis dynamic parameter(s)(velocity, acceleration, deceleration, or jerk) set in the function block. Correct the setting for the dynamic parameters in the function block against Axis Dynamics configuration page.
03	MC_FB_ERR_PARAM	The function block cannot execute because there is invalid parameter other than velocity, acceleration, deceleration, or jerk, set in the function block. Correct the setting for the parameters (for example, mode or position) for the function block.
04	MC_FB_ERR_AXISNUM	The function block cannot execute because the axis does not exist, the axis configuration data is corrupted, or the axis is not correctly configured.
05	MC_FB_ERR_MECHAN	The function block cannot execute because this axis gets a fault due to drive or mechanical issues. Check the connection between the drive and the controller (Drive Ready and In-Position signals), and ensure the drive is operating normally.
06	MC_FB_ERR_NOPOWER	The function block cannot execute because the axis is not powered on. Power on the axis using MC_Power function block.
07	MC_FB_ERR_RESOURCE	The function block cannot execute because the resource required by the function block is controlled by some other function block or it is not available. Ensure the resource required by the function block is available for use. Examples: <ul style="list-style-type: none"> <li>• MC_Power try to control the same axis.</li> <li>• MC_Stop are executed against the same axis at the same time.</li> <li>• MC_TouchProbe are executed against the same axis at the same time.)</li> <li>• MC_TouchProbe is executed, while touch probe input is not enabled in Motion Configuration.</li> </ul>
08	MC_FB_ERR_PROFILE	The function block cannot execute because the motion profile defined in the function block cannot be achieved. Correct the profile in the function block.
09	MC_FB_ERR_VELOCITY	The function block cannot execute because the motion profile requested in the function block cannot be achieved due to current axis velocity. Examples: <ul style="list-style-type: none"> <li>• The function block requests the axis to reverse the direction while the axis is moving.</li> <li>• The required motion profile cannot be achieved due to current velocity too low or too high.</li> </ul> Check the motion profile setting in the function block, and correct the profile, or re-execute the function block when the axis velocity is compatible with the requested motion profile.
0A	MC_FB_ERR_SOFT_LIMIT	This function block cannot execute as it will end up moving beyond the Soft Limit, or the function block is cancelled as the Soft Limit has been reached. Check the velocity or target position settings in the function block, or adjust Soft Limit setting.
0B	MC_FB_ERR_HARD_LIMIT	This function block is cancelled as the Hard Limit switch active state has been detected during axis movement, or cancelled as the Hard Limit switch active state has been detected before axis movement starts. Move the axis away from the Hard Limit switch in the opposite direction.
0C	MC_FB_ERR_LOG_LIMIT	This function block cannot execute as it will end up moving beyond the PTO Accumulator logic limit, or the function block is cancelled as the PTO Accumulator logic limit has been reached. Check the velocity or target position settings for the function block. Or use MC_SetPosition function block to adjust the axis coordinate system.
0D	MC_FB_ERR_ERR_ENGINE	A motion engine execution error is detected during the execution of this function block. Power cycle the whole motion setup, including controller, drives and actuators, and re-download the User Application. If the fault persists, call Tech support.

Value	MACRO ID	Description
10	MC_FB_ERR_NOT_HOMED	The function block cannot execute because the axis need to be homed first. Execute homing against the axis using MC_Home function block.
80	MC_FB_ERR_PARAM_MODIFIED	Warning: The requested velocity for the axis has been adjusted to a lower value. The function block executes successfully at a lower velocity.

## Axis error scenarios

In most cases, when a movement function block instruction issued to an axis results in a function block error, the axis transitions to an Error state, and the corresponding ErrorID element is set on the AXIS\_REF data for the axis.

In the following situations, the axis may not transition to an Error state, and it is possible for the user application to issue a successful movement function block to the axis after the axis state changes.

Scenario	Example
A movement function block instructs an axis, but the axis is in a state in which the function block cannot be executed properly.	The axis has no power, or the axis is in a Homing sequence, or in an Error Stop state.
A movement function block instructs an axis, but the axis is still controlled by another movement function block. The axis cannot allow the motion to be controlled by the new function block without going to a full stop.	The new function block commands the axis to change motion direction.
When one movement function block tries to control an axis, but the axis is still controlled by another movement function block, and the newly-defined motion profile cannot be realized by the controller.	User Application issues an S-Curve MC_MoveAbsolute function block to an axis with too short a distance given when the axis is moving.

## AXIS\_REF data type

The AXIS\_REF data type is a data structure that contains information for a motion axis and is used as an input and output variable in all motion control function blocks. An instance of an AXIS\_REF data type is automatically created when you add a motion axis to the configuration.

Parameter	Data type	Description
Axis_ID	AXIS_REF	The logic axis ID automatically assigned by Connected Components Workbench. It cannot be edited or viewed by user.
Error_Flag	BOOL	Indicates whether an error is present in the axis. Once an axis is flagged with an error, and the error ID is not zero, the axis must be reset using MC_Reset before issuing any other movement function block.
AxisHomed	BOOL	Indicates whether homing operation is successfully executed for the axis or not. When the user tries to redo homing for an axis with AxisHomed already set (homing performed successfully), and the result is not successful, the AxisHomed status is cleared.
ConstVel	BOOL	Indicates whether the axis is in Constant Velocity movement or not. Stationary axis is not considered in Constant Velocity.
AccFlag	BOOL	Indicates whether the axis is in an Accelerating movement or not.
DecelFlag	BOOL	Indicates whether the axis is in an Decelerating movement or not.
AxisState	USINT	Indicates the current state of the axis.
ErrorID	UINT	Indicates the cause for axis error when error is indicated by ErrorFlag. This error usually results from motion control function block execution failure.

ExtraData	UINT	Reserved.
TargetPos	REAL	Indicates the final target position of the axis for MoveAbsolute and MoveRelative function blocks. For MoveVelocity, Stop, and Halt function blocks, TargetPos is 0 except when the TargetPos set by previous position function blocks is not cleared.
CommandPos	REAL	During motion, this is the current position the controller commands the axis to take. There may be a slight delay between the axis actual position and this CommandPos.
TargetVel	REAL	The maximum target velocity instructed to the axis for a moving function block. The value of TargetVel in current function block, or smaller than it, depending on the other parameters in the same function block.
CommandVel	REAL	During motion, this element indicates the current velocity the controller instructs the axis to use. Note that there may be a slight difference between the axis actual velocity and CommandVel, due to the drive delay or drive adjustment overshoot.

## FB\_AXIS\_REF data type

The FB\_AXIS\_REF data type is a data structure that contains information for a Motion Feedback Axis. It is used as an input and output variable in motion control function blocks. An instance of an FB\_AXIS\_REF data type is automatically created when you add a HSC module and the mode is configured as Feedback Axis mode.

---

**IMPORTANT** Once a Feedback Axis is flagged with an error, and the error ID is not zero, the FBAxis must be reset using MC\_Reset before issuing any other movement function block.

---

Parameter	Data type	Description
Axis_ID	FB_AXIS_REF	The logic axis ID automatically assigned by Connected Components Workbench. It cannot be edited or viewed by user.
ErrorFlag	BOOL	Indicates whether an error is present in the Feedback Axis.
ConstVel	BOOL	Indicates whether the Feedback Axis is in Constant Velocity movement or not. Stationary axis is not considered in Constant Velocity.
AccelFlag	BOOL	Indicates whether the Feedback Axis is in an Accelerating movement or not.
DecelFlag	BOOL	Indicates whether the Feedback Axis is in an Decelerating movement or not.
AxisState	USINT	Indicates the current state of the Feedback Axis.
ErrorID	UINT	Indicates the cause for axis error when error is indicated by ErrorFlag. This error usually results from motion control function block execution failure.
ExtraData	UINT	Reserved.
ActualPos	REAL	Actual mechanical position read back from Motion feedback channel (HSC).
ActualVel	REAL	Actual mechanical velocity read back from Motion feedback channel (HSC).

## Axis variables

Axis variables are used to control position, speed, acceleration, and error for a given motion control axis.

### To assign a variable to an Axis output parameter:

- In a Function Block Diagram  
Graphically connect the Axis output parameter of a motion control function block to the AxisIn input parameter of another motion control function block for convenience. For example, connect MC\_POWER Axis output parameter to MC\_HOME AxisIn input parameter.
- In a Ladder Diagram  
A variable can not be assigned to the Axis output parameter of a motion control function block because it is read-only.

### Monitor an AXIS\_REF variable

Monitor an AXIS\_REF or a FBAXIS\_REF variable in the software while connected to the controller, when the motion engine is active, or in the user application as part of user logic. You can also monitor the AXIS\_REF or FBAXIS\_REF variable remotely through various communication channels.

Cancels Motion function blocks that are connected to trigger events.

MC\_AbortTrigger only executes when assigned to an axis that is controlled by MC\_TouchProbe.

Languages supported: Function Block Diagram, Ladder Diagram, Structured Text.

This instruction applies to the Micro830, Micro850 and Micro870 controllers that support motion control.

## MC\_AbortTrigger (motion control abort trigger)

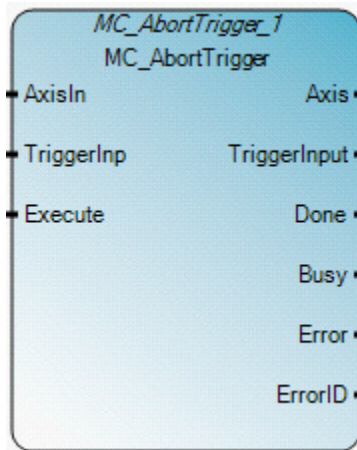

Use this table to help determine the parameter values for this instruction.

Parameter	Parameter	Data type	Description
EN	Input	BOOL	Instruction block enable. TRUE - execute current MC_AbortTrigger computation. FALSE - there is no computation. Applies only to Ladder Diagram programs.

AxisIn	Input	<a href="#">AXIS_REF</a> on <a href="#">page 413</a> <a href="#">FB_AXIS_REF</a> on <a href="#">page 414</a>	Use the AXIS_REF data type to define the AxisIn parameter. If the axis is a FB_Axis (feedback axis), use the FB_AXIS_REF data type to define AxisIn parameters.
TriggerInp	Input	USINT	This parameter is ignored.
Execute	Input	BOOL	When TRUE, cancels the trigger event at the rising edge.
ENO	Output	BOOL	Enable output. Applies only to Ladder Diagram programs.
Axis	Output	AXIS_REF	Axis output is read-only in Ladder Diagram programs.
TriggerInput	Output	USINT	This parameter is ignored.
Done	Output	BOOL	TRUE - the trigger event is cancelled.
Busy	Output	BOOL	TRUE - the function block is not finished.
Error	Output	BOOL	TRUE - an error is detected.
ErrorID	Output	UINT	A unique numeric that identifies the error. The errors for this instruction are defined in Motion control function block error IDs.

### MC\_AbortTrigger Function Block Diagram example

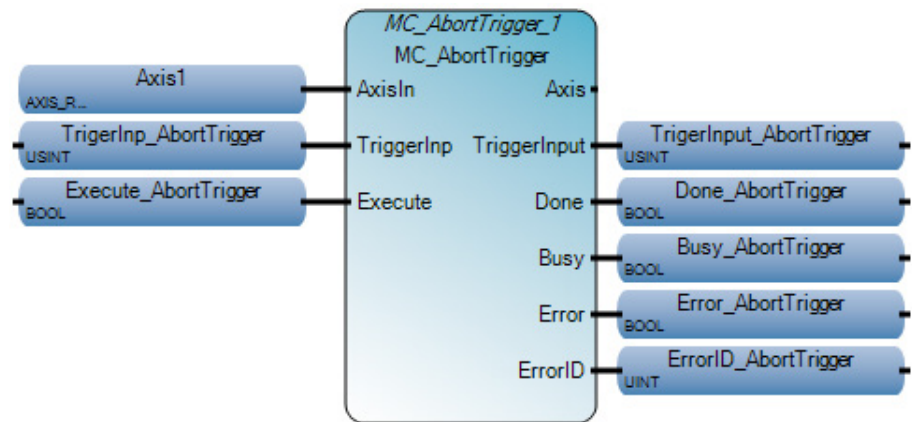



### MC\_AbortTrigger Ladder Diagram example

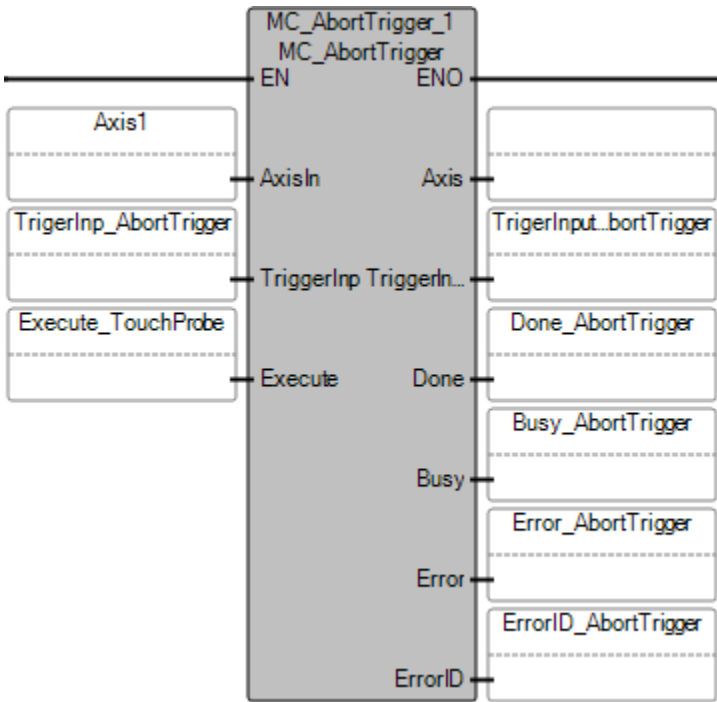

### MC\_AbortTrigger Structured Text example

```

MC_AbortTrigger_1(
void MC_AbortTrigger_1(AXIS_REF AxisIn, USINT TriggerInp, BOOL Execute)
Type : MC_AbortTrigger, Abort Function Blocks connected to trigger events (e.g. MC_TouchProbe)

MC_AbortTrigger_1(Axis1, TrigerInp_AbortTrigger, Execute_AbortTrigger);
Done_AbortTrigger := MC_AbortTrigger_1.Done;
Busy_AbortTrigger := MC_AbortTrigger_1.Busy;
Error_AbortTrigger := MC_AbortTrigger_1.Error;
ErrorID_AbortTrigger := MC_AbortTrigger_1.ErrorID;
    
```

### Results

Name	Logical Value	Physical Value	Lock	Data Type
TrigerInp_AbortTrig	0	N/A	<input type="checkbox"/>	USINT
Execute_AbortTrig	<input checked="" type="checkbox"/>	N/A	<input type="checkbox"/>	BOOL
TrigerInput_AbortT	0	N/A	<input type="checkbox"/>	USINT
Done_AbortTrigger	<input checked="" type="checkbox"/>	N/A	<input type="checkbox"/>	BOOL
Busy_AbortTrigger	<input type="checkbox"/>	N/A	<input type="checkbox"/>	BOOL
Error_AbortTrigger	<input type="checkbox"/>	N/A	<input type="checkbox"/>	BOOL
ErrorID_AbortTrigg	0	N/A	<input type="checkbox"/>	UINT

## MC\_Halt (motion control halt)

Commands a controlled motion stop under normal operating conditions.

Operating details;

- The axis state changes to DiscreteMotion, until velocity is zero. When velocity reaches zero, Done is set to True and the axis state changes to StandStill.
- It is possible to execute another motion command during deceleration of the axis, which overrides MC\_Halt.
- If MC\_Halt is issued when the axis state is Homing, the instruction block reports an error, and the homing process is not interrupted.

Languages supported: Function Block Diagram, Ladder Diagram, Structured Text.

This instruction applies to the Micro830, Micro850 and Micro870 controllers that support motion control.

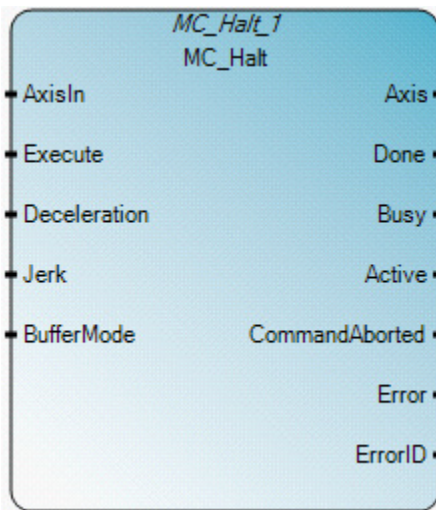

Use this table to help determine the parameter values for this instruction.

	Parameter type	Data type	Description
EN	Input	BOOL	Instruction block enable. TRUE - execute current MC_Halt computation. FALSE - there is no computation. Applies to Ladder Diagram programs.
AxisIn	Input	AXIS_REF	Use the AXIS_REF data type parameters to define AxisIn.
Execute	Input	BOOL	Indicates when to start motion. TRUE - start the motion at rising edge. FALSE - do not start motion. Executing MC_Halt during homing, MC_Halt is set to MC_FB_ERR_STATE and the homing process continues.
Deceleration	Input	REAL	Value of the deceleration (always positive) (decreasing energy of the motor). If Deceleration <= 0 and the axis state is not Standstill, MC_Halt is set to MC_FB_ERR_RANGE.
Jerk	Input	REAL	Value of the Jerk (always positive). If Jerk < 0 and the axis state is Standstill, MC_Halt is set to MC_FB_ERR_RANGE.
BufferMode	Input	SINT	Not used. The mode is always MC_Aborting.

	Parameter type	Data type	Description
ENO	Output	BOOL	Enable output. Applies only to Ladder Diagram programs.
Axis	Output	<a href="#">AXIS_REF</a> on <a href="#">page 413</a>	Axis output is read-only in Ladder Diagram programs.
Done	Output	BOOL	Zero velocity reached.
Busy	Output	BOOL	The instruction block is not finished.
Active	Output	BOOL	Indicates that the instruction block has control on the axis.
CommandAborted	Output	BOOL	Command is overridden by another command, or error stop.
Error	Output	BOOL	Indicates an error occurred. TRUE - An error is detected. FALSE - No error.
ErrorID	Output	UINT	A unique numeric that identifies the error. The errors for this instruction are defined in <a href="#">Motion control function block error IDs</a> on <a href="#">page 411</a> .

**MC\_Halt Function Block Diagram example**

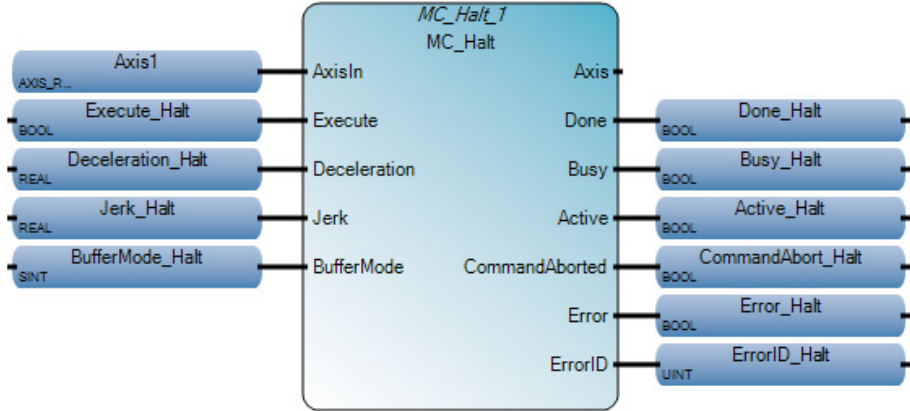

### MC\_Halt Ladder Diagram example

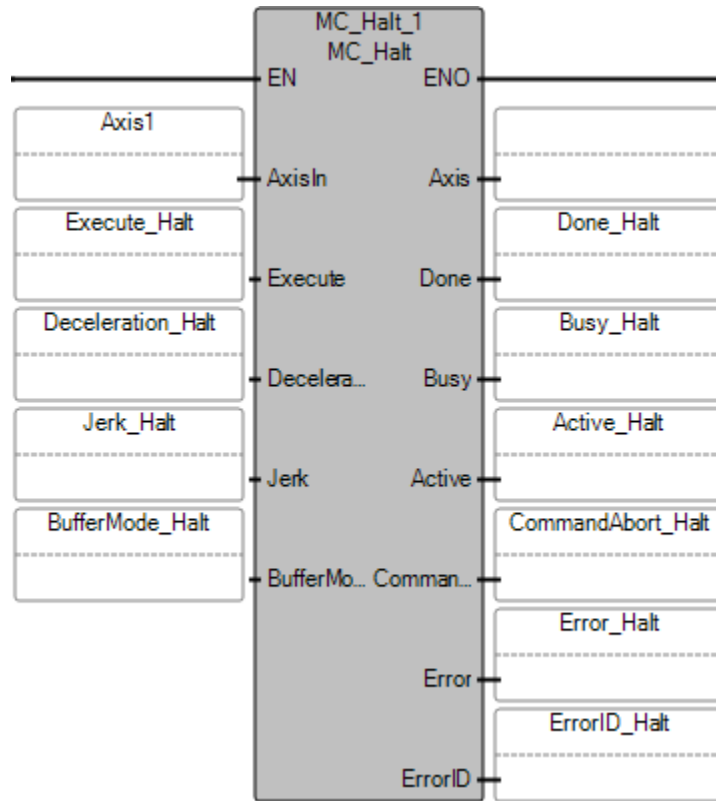

### MC\_Halt Structured Text example

```

1 MC_Halt_1(
void MC_Halt_1(AXIS_REF AxisIn, BOOL Execute, REAL Deceleration, REAL Jerk, SINT BufferMode)
Type : MC_Halt, Commands a controlled motion stop. The axis is moved to the state Discrete Motion, until the velocity is zero.

Deceleration_Halt := 10.0;
Jerk_Halt := 10.0;
MC_Halt_1(Axis1,Execute_Halt,Deceleration_Halt,Jerk_Halt,BufferMode_Halt);
Done_Halt := MC_Halt_1.Done;
Busy_Halt := MC_Halt_1.Busy;
Active_Halt := MC_Halt_1.Active;
CommandAbort_Halt := MC_Halt_1.CommandAborted;
Error_Halt := MC_Halt_1.Error;
ErrorID_Halt := MC_Halt_1.ErrorID;

```

### Results

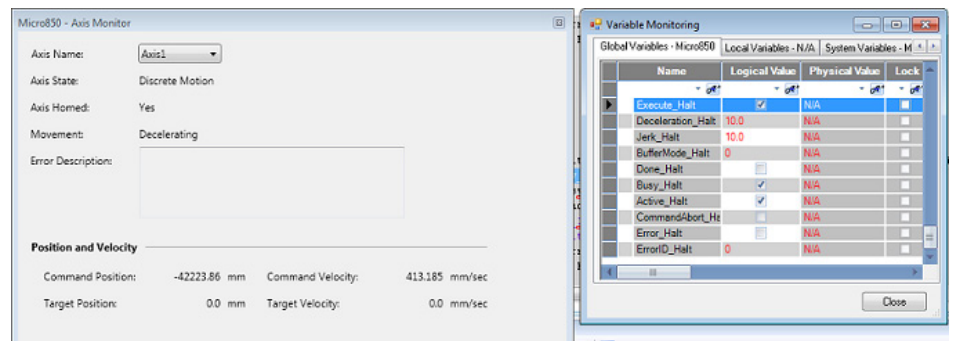

## MC\_Home (motion control home)

Commands the axis to perform the <search home> sequence. The details of this sequence are manufacturer dependent and can be set by the axis parameters. The Position input is used to set the absolute position when a reference signal is detected, and the configured Home offset is reached.

Operation details:

- After MC\_Power is issued, the axis Homed status is reset to 0 (not homed). In most cases, after the axis is powered on, the MC\_Home function block needs to be executed to calibrate the axis position and the Home reference.
- The MC\_Home function block can only be cancelled using a MC\_Stop or a MC\_Power function block. If it is cancelled before it completes, the previously searched Home position is considered invalid and the axis Homed status is cleared.

Languages supported: Function Block Diagram, Ladder Diagram, Structured Text.

This instruction applies to the Micro830, Micro850 and Micro870 controllers that support motion control.

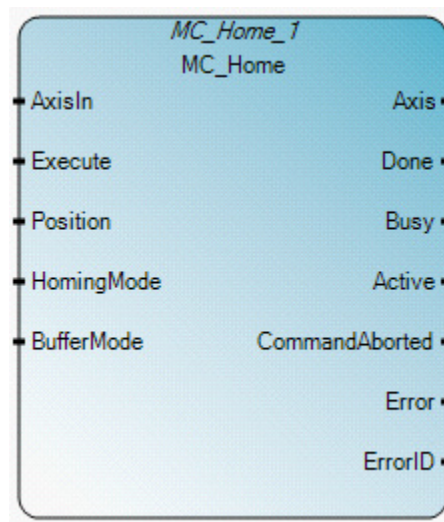

Use this table to help determine the parameter values for this instruction.

Parameter	Parameter type	Data type	Description
EN	Input	BOOL	Instruction block enable. TRUE - execute current MC_Home computation. FALSE - there is no computation. Applies only to Ladder Diagram programs.
AxisIn	Input	AXIS_REF	Use the AXIS_REF data type parameters to define AxisIn.
Execute	Input	BOOL	Indicates when to start motion. TRUE - start the motion at rising edge. FALSE - do not start motion.

Parameter	Parameter type	Data type	Description
Position	Input	REAL	Absolute position is set when the reference signal is detected and configured Home offset is reached. The value range for this input is -0x40000000 - 0x40000000 physical pulse after the position is converted from user position unit to PTO pulse. Set the Position value within the Soft Limit. An invalid input value results in an error. Error ID = <b>MC_FB_ERR_PARAM</b> .
HomingMode	Input	SINT	Enum input for Homing mode.
BufferMode	Input	SINT	Not used. The mode is always mcAborting.
ENO	Output	BOOL	Enable output. Applies only to Ladder Diagram programs.
Axis	Output	<a href="#">AXIS_REF</a> on <a href="#">page 413</a>	Axis output is read-only in Ladder Diagram programs.
Done	Output	BOOL	TRUE - the Homing operation completed successfully and the axis state is set to StandStill. FALSE - Homing operation is ongoing or incomplete.
Busy	Output	BOOL	TRUE - the instruction block is not finished. FALSE - the instruction block is finished.
Active	Output	BOOL	TRUE - indicates that the instruction block has control on the axis.
CommandAborted	Output	BOOL	TRUE - command was overridden by another command, or error stop.
Error	Output	BOOL	Indicates an error occurred. TRUE - An error is detected. FALSE - No error.
ErrorID	Output	UNIT	A unique numeric that identifies the error. The errors for this instruction are defined in <a href="#">Motion control function block error IDs</a> on <a href="#">page 411</a> .

## HomingModes

Use this table to help determine the values for the HomingMode parameter in the MC\_Home [motion control instruction](#) on [page 405](#).

Value	Name	Description
0x00	MC_HOME_ABS_SWITCH	Homing process by searching Home Absolute switch
0x01	MC_HOME_LIMIT_SWITCH	Homing process by searching limit switch
0x02	MC_HOME_REF_WITH_ABS	Homing process by searching Home Absolute switch plus using encoder reference pulse
0x03	MC_HOME_REF_PULSE	Homing process by searching limit switch plus using encoder reference pulse
0x04	MC_HOME_DIRECT	Static homing process with direct forcing a home position from user reference. The function block will set current position the mechanism is in as home position, with its position determined by the input parameter, "Position"

### MC\_Home Function Block Diagram example

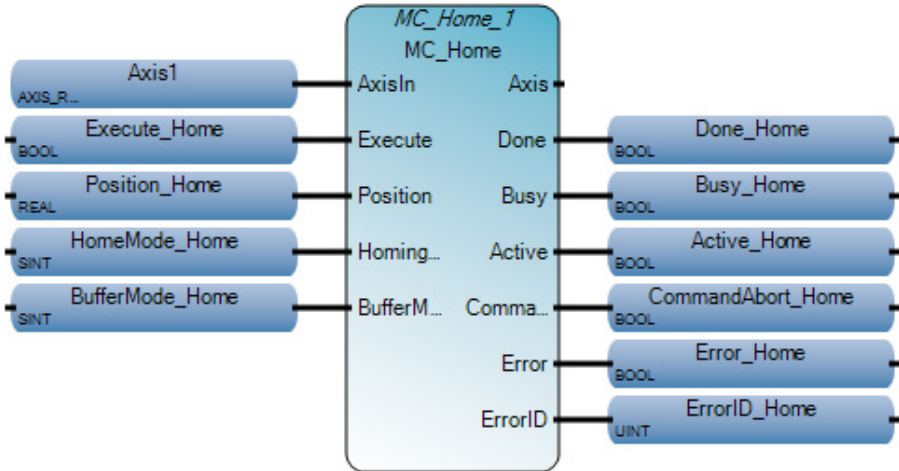

### MC\_Home Ladder Diagram example

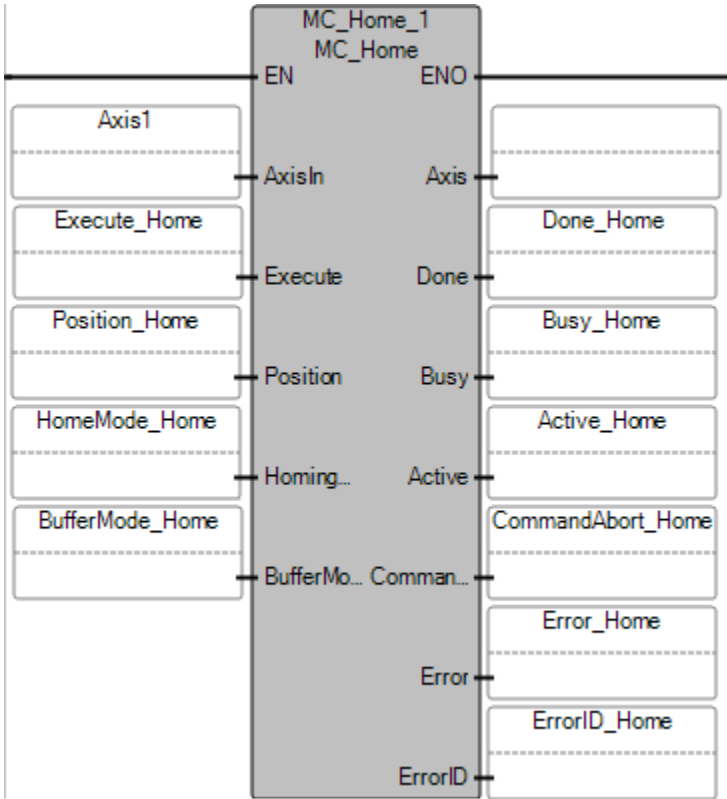

### MC\_Home Structured Text example

```
MC_Home_1(
void MC_Home_1(AXIS_REF AxisIn, BOOL Execute, REAL Position, SINT HomingMode, SINT BufferMode)
Type : MC_Home, Commands the axis to perform the home searching sequence
```

```

Position_Home := -50000.0;
HomeMode_Home := 4; (*1*)
MC_Home_1(Axis1,Execute_Home,Position_Home,HomeMode_Home,BufferMode_Home);
Done_Home := MC_Home_1.Done;
Busy_Home := MC_Home_1.Busy;
Active_Home := MC_Home_1.Active;
CommandAbort_Home := MC_Home_1.CommandAborted;
Error_Home := MC_Home_1.Error;
ErrorID_Home := MC_Home_1.ErrorID;
    
```

## Results



Name	Alias	Logical Value	Physical Value	Initial Value	Lock	Data
Execute_Home		<input checked="" type="checkbox"/>	N/A		<input type="checkbox"/>	BOOL
Position_Home		-50000.0	N/A		<input type="checkbox"/>	REAL
HomeMode_Home		1	N/A		<input type="checkbox"/>	SINT
BufferMode_Home		0	N/A		<input type="checkbox"/>	SINT
Done_Home		<input type="checkbox"/>	N/A		<input type="checkbox"/>	BOOL
Busy_Home		<input checked="" type="checkbox"/>	N/A		<input type="checkbox"/>	BOOL
Active_Home		<input checked="" type="checkbox"/>	N/A		<input type="checkbox"/>	BOOL
CommandAbort_Hc		<input type="checkbox"/>	N/A		<input type="checkbox"/>	BOOL
Error_Home		<input type="checkbox"/>	N/A		<input type="checkbox"/>	BOOL
ErrorID_Home		0	N/A		<input type="checkbox"/>	UINT

## MC\_MoveAbsolute (motion control move absolute)

Commands a controlled motion to a specified absolute position.

Operation details:

- For the Micro800 controller,
  - The sign of the input Velocity for a MC\_MoveAbsolute function block is ignored because the motion direction is determined by the Current position and the Target position.
  - The input Direction for a MC\_MoveAbsolute function block is ignored because there is only one mathematical solution to reach the Target position.
- If the MC\_MoveAbsolute function block is issued when the Micro800 controller axis state is StandStill and the relative distance to move is zero, the execution of the function block is immediately reported as Done.
- If a MC\_MoveAbsolute function block is issued to an axis that is not in the Homed, position, the function block reports an error.
- The MoveAbsolute function block completes with Velocity zero if it is not overridden by another function block.



Languages supported: Function Block Diagram, Ladder Diagram, Structured Text.

This instruction applies to the Micro830, Micro850 and Micro870 controllers that support motion control.

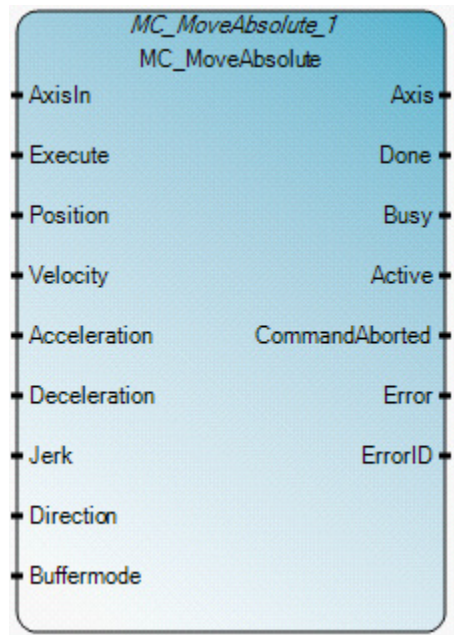

Use this table to help determine the parameter values for this instruction.

Parameter	Parameter type	Data type	Description
EN	Input	BOOL	Instruction block enable. TRUE - execute current MC_MoveAbsolute computation. FALSE - there is no computation. Applies only to Ladder Diagram programs.
AxisIn	Input	AXIS_REF	Use the AXIS_REF data type parameters to define AxisIn.
Execute	Input	BOOL	Indicates when to start motion. TRUE - start the motion at rising edge. FALSE - do not start motion. The axis should be in the home position when this execute command is issued or an error occurs, MC_FB_ERR_NOT_HOMED.
Position	Input	REAL	Target position for the motion in technical unit (negative or positive). The technical unit is defined in the <b>Motion - General</b> configuration page for an axis.
Velocity	Input	REAL	Value of the maximum velocity. The maximum velocity may not be reached when Jerk = 0. The sign of Velocity is ignored, the motion direction is determined by the input Position.
Acceleration	Input	REAL	Value of the acceleration (always positive - increasing energy to the motor.) user unit/sec <sup>2</sup>
Deceleration	Input	REAL	Value of the deceleration (always positive - decreasing energy to the motor). u/sec <sup>2</sup>

Parameter	Parameter type	Data type	Description
Jerk	Input	REAL	Value of the Jerk (always positive). u/sec <sup>3</sup> When the value of the input Jerk = 0, the Trapezoid profile is calculated by Motion Engine. When Jerk > 0, the S-Curve profile is calculated.
Direction	Input	SINT	This parameter is not used.
BufferMode	Input	SINT	This parameter is not used.
ENO	Output	BOOL	Enable output. Applies only to Ladder Diagram programs.
Axis	Output	<a href="#">AXIS_REF</a> on <a href="#">page 413</a>	Axis output is read-only in Ladder Diagram programs.
Done	Output	BOOL	When TRUE, command position reached. When the In-Position Input is configured as Enabled for this axis, the drive needs to set In-Position Input signal active before this Done bit goes to True. This action completes with velocity zero unless it is cancelled.
Busy	Output	BOOL	When TRUE, the function block is not finished.
Active	Output	BOOL	When TRUE, indicates that the function block has control of the axis
CommandAborted	Output	BOOL	When TRUE, the Command was overridden by another command, or error stop.
Error	Output	BOOL	Indicates an error occurred. TRUE - An error is detected. FALSE - No error.
ErrorID	Output	UINT	A unique numeric that identifies the error. The errors for this instruction are defined in <a href="#">Motion control function block error IDs</a> on <a href="#">page 41</a> .

### MC\_MoveAbsolute Function Block Diagram example

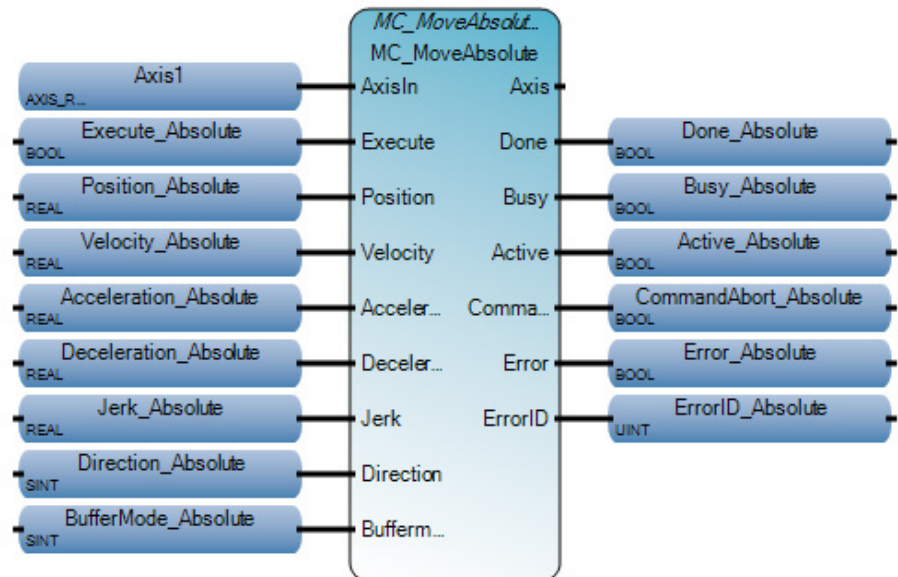

### MC\_MoveAbsolute Ladder Diagram example



### MC\_MoveAbsolute Structured Text example

```

MC_MoveAbsolute_1
void MC_MoveAbsolute_1(AXIS_REF AxisIn, BOOL Execute, REAL Position, REAL Velocity, REAL Acceleration, REAL Deceleration, REAL Jerk, SINT Direction, SINT Buffermode)
Type: MC_MoveAbsolute, Commands a controlled motion to a specified absolute position

Position_Absolute := 50000.0;
Velocity_Absolute := 500.0;
Acceleration_Absolute := 1000.0;
Deceleration_Absolute := 1000.0;
Jerk_Absolute := 10.0;
MC_MoveAbsolute_1(Axis1, Execute_Absolute, Position_Absolute, Velocity_Absolute,
Acceleration_Absolute, Deceleration_Absolute, Jerk_Absolute, Direction_Absolute, BufferMode_Absolute);
Done_Absolute := MC_MoveAbsolute_1.Done;
Busy_Absolute := MC_MoveAbsolute_1.Busy;
Active_Absolute := MC_MoveAbsolute_1.Active;
CommandAbort_Absolute := MC_MoveAbsolute_1.CommandAborted;
Error_Absolute := MC_MoveAbsolute_1.Error;
ErrorID_Absolute := MC_MoveAbsolute_1.ErrorID;
    
```

## Results

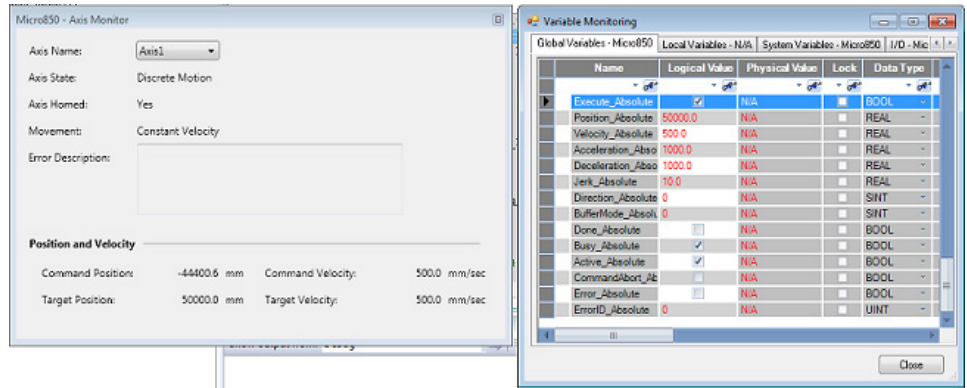

### MC\_MoveRelative (motion control move relative)

Commands a controlled motion of a specified distance relative to the actual position at the time of the execution.

Operation details:

- Because the motion direction for MC\_MoveRelative is determined by the current position and the target position, the sign of the Velocity is ignored.
- MoveRelative completes with Velocity zero if it is not overridden by another function block.
- If MC\_MoveRelative is issued when the Micro800 controller axis state is StandStill and the relative distance to move is zero, the execution of the function block is immediately reported as Done.
- For a Micro800 controller, the sign of the input Velocity for MC\_MoveRelative is ignored because the motion direction is determined by the Current position and the Target position.

Languages supported: Function Block Diagram, Ladder Diagram, Structured Text.

This instruction applies to the Micro830, Micro850 and Micro870 controllers that support motion control.

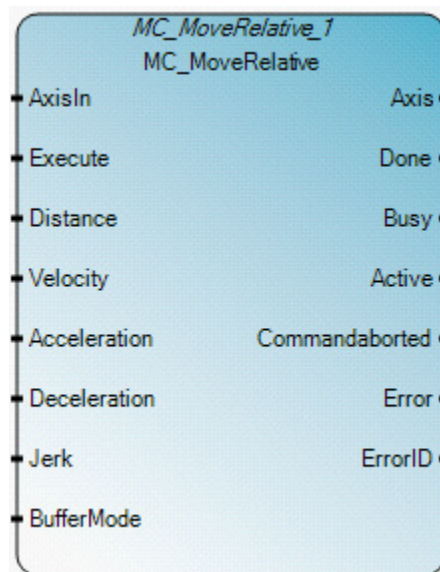

## MC\_MoveRelative operation

Use this table to help determine the parameter values for this instruction.

Parameter	Parameter type	Data type	Description
EN	Input	BOOL	Instruction block enable. TRUE - execute current MC_MoveRelative computation. FALSE - there is no computation. Applies only to Ladder Diagram programs.
AxisIn	Input	<a href="#">AXIS_REF</a> on <a href="#">page 413</a>	Use the AXIS_REF data type parameters to define AxisIn.
Execute	Input	BOOL	Indicates when to start motion. TRUE - start the motion at rising edge. FALSE - do not start motion.
Distance	Input	REAL	Relative distance for the motion (in technical unit [u]).
Velocity	Input	REAL	Value of the maximum velocity (not necessarily reached) [u/s]. As the motion direction is determined by input Position, the sign of Velocity is ignored by the function block. The maximum velocity may not be reached when Jerk = 0.
Acceleration	Input	REAL	Value of the acceleration (increasing energy of the motor) [u/s <sup>2</sup> ]
Deceleration	Input	REAL	Value of the deceleration (decreasing energy of the motor) [u/s <sup>2</sup> ]
Jerk	Input	REAL	Value of the Jerk [u/s <sup>3</sup> ]
BufferMode	Input	SINT	This parameter is not used.
ENO	Output	BOOL	Enable output. Applies only to Ladder Diagram programs.
Axis	Output	AXIS_REF	Axis output is read-only in Ladder Diagram programs.
Done	Output	BOOL	TRUE - commanded distance reached. When the In-Position input is enabled for an axis, the In-Position signal must be set to active before Done = True.
Busy	Output	BOOL	TRUE - the instruction block is not finished. FALSE - the instruction block is finished.
Active	Output	BOOL	TRUE - indicates that the instruction block has control on the axis.
CommandAborted	Output	BOOL	TRUE - command was overridden by another command, or Error Stop.
Error	Output	BOOL	Indicates an error occurred. TRUE - An error is detected. FALSE - No error.
ErrorID	Output	UINT	A unique numeric that identifies the error. The errors for this instruction are defined in <a href="#">Motion control function block error IDs</a> on <a href="#">page 41</a> .

### MC\_MoveRelative Function Block Diagram example

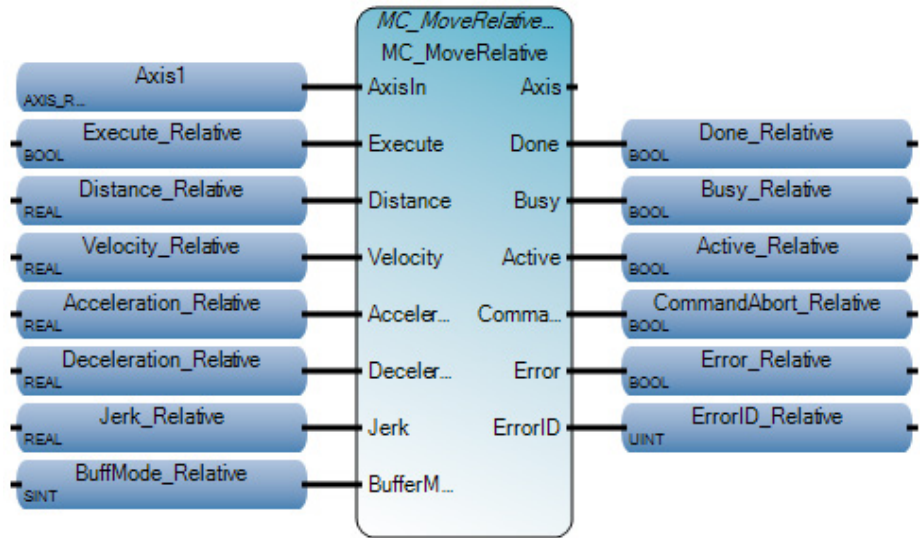

### MC\_MoveRelative Ladder Diagram example

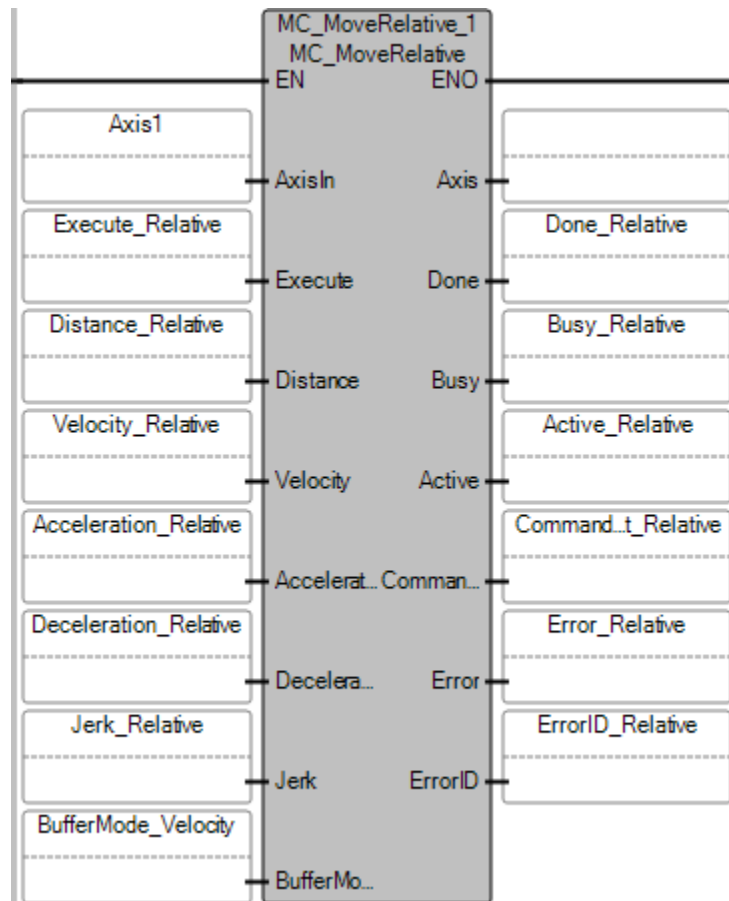

## MC\_MoveRelative Structured Text example

```
MC_MoveRelative_1{  
void MC_MoveRelative_1(AXIS_REF AxisIn, BOOL Execute, REAL Distance, REAL Velocity, REAL Acceleration, REAL Deceleration, REAL Jerk, SINT BufferMode)  
Type : MC_MoveRelative, Commands a controlled motion of a specified distance relative to the actual position at the time of the execution.  
  
Distance_Relative := 100000.0;  
Velocity_Relative := 300.0;  
Acceleration_Relative := 100.0;  
Deceleration_Relative := 100.0;  
Jerk_Relative := 100.0;  
MC_MoveRelative_1(Axis1,Execute_Relative,Distance_Relative,  
Velocity_Relative,Acceleration_Relative,Deceleration_Relative,Jerk_Relative,BufferMode_Relative);  
Done_Relative := MC_MoveRelative_1.Done;  
Busy_Relative := MC_MoveRelative_1.Busy;  
Active_Relative := MC_MoveRelative_1.Active;  
CommandAbort_Relative := MC_MoveRelative_1.Commandaborted;  
Error_Relative := MC_MoveRelative_1.Error;  
ErrorID_Relative := MC_MoveRelative_1.ErrorID;
```

## Results

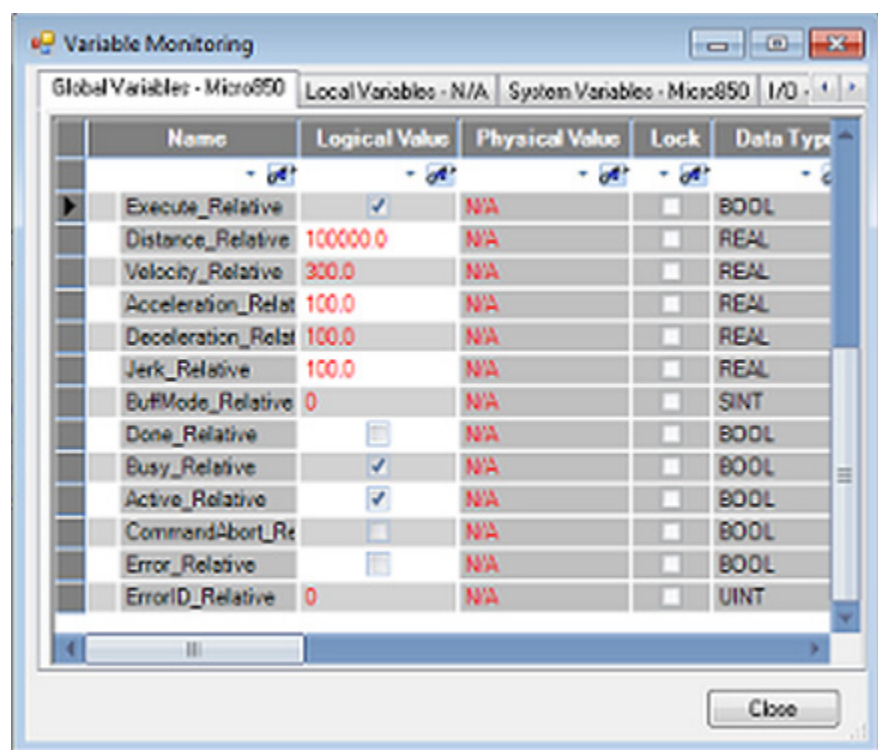
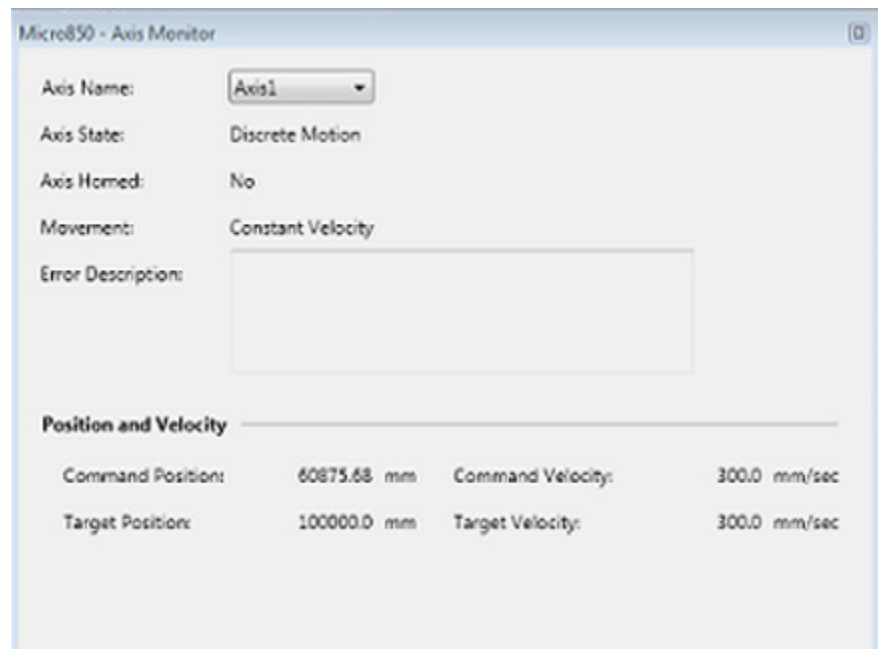

### MC\_MoveVelocity (motion control move velocity)

Commands a never ending controlled motion at a specified velocity.

Operation details:

- If the DirectionIn input for MC\_MoveVelocity is equal to 0 and:
  - the axis is in a moving state, the sign of the Velocity input is ignored, the axis continues to move in its current direction, and new dynamic parameters are applied.
  - the axis is not in a moving state, MC\_MoveVolecity reports an error.



- If the PTO Pulse limit is reached during execution of MC\_MoveVelocity, the PTO Accumulator value is rolled over to 0 (or to the opposite Soft Limit if the limit is activated) and execution continues.
- If the axis is in a moving state, and MC\_MoveVelocity issues a motion in which the direction (the sign of Velocity \* Direction) is the opposite of the current motion direction, the MC\_MoveVelocity reports an error.
- Once the signal 'InVelocity' is set, it indicates MC\_MoveVelocity is complete. Any subsequent motion event has no effect on the MC\_MoveVelocity outputs except the signal 'InVelocity'.
- The InVelocity output of MC\_MoveVelocity stays True once the Velocity of the axis reaches the commanded Velocity or until MC\_MoveVelocity is stopped.
- The sign of (Velocity \* Direction) determines the motion direction for MC\_MoveVelocity. If the Velocity sign and the Direction sign are the same, positive motion is issued. If the Velocity sign and the Direction sign are different, negative motion is issued.
- The signal 'InVelocity' is reset when MC\_MoveVelocity is overridden by another function block or Motion event, or at the falling edge of 'Execute'.
- To stop or change the motion initiated by MC\_MoveVelocity, the instruction block must be interrupted or overridden by another instruction block, which includes executing MC\_MoveVelocity again with different parameters.
- If MC\_MoveVelocity is issued with the axis state in StandStill (not controlled by another function block) and a function block error occurs, the axis state goes to ErrorStop.

Languages supported: Function Block Diagram, Ladder Diagram, Structured Text.

This instruction applies to the Micro830, Micro850 and Micro870 controllers that support motion control.



Use this table to help determine the parameter values for this instruction.

Parameter	Parameter type	Data type	Description
EN	Input	BOOL	Instruction block enable. TRUE - execute current MC_MoveVelocity computation. FALSE - there is no computation. Applies only to Ladder Diagram programs.
AxisIn	Input	AXIS_REF	Use the AXIS_REF data type parameters to define AxisIn.
Execute	Input	BOOL	Indicates when to start motion. TRUE - start the motion at rising edge. FALSE - do not start motion.
Velocity	Input	REAL	Value of the maximum velocity [u/s].
Acceleration	Input	REAL	Value of the acceleration (increasing energy of the motor) [u/s <sup>2</sup> ]
Deceleration	Input	REAL	Value of the deceleration (decreasing energy of the motor) [u/s <sup>2</sup> ]
Jerk	Input	REAL	Value of the Jerk [u/s <sup>3</sup> ]
DirectionIn	Input	SINT	The valid values are: -1, 0, 1.
BufferMode	Input	SINT	This parameter is not used.
ENO	Output	BOOL	Enable output. Applies only to Ladder Diagram programs.
Axis	Output	<a href="#">AXIS_REF</a> on <a href="#">page 413</a>	Axis output is read-only in Ladder Diagram programs.
InVelocity	Output	BOOL	TRUE - commanded velocity was reached (first time).
Busy	Output	BOOL	TRUE - the instruction block is not finished. FALSE - the instruction block is finished.
Active	Output	BOOL	TRUE - indicates the function block has control on the axis.
Direction	Output	SINT	The valid values are: -1, 0, 1.
CommandAborted	Output	BOOL	TRUE - command was overridden by another command, or Error Stop.
Error	Output	BOOL	Indicates an error occurred. TRUE - An error is detected. FALSE - No error.
ErrorID	Output	UINT	A unique numeric that identifies the error. The errors for this instruction are defined in <a href="#">Motion control function block error IDs</a> on <a href="#">page 411</a> .

### MC\_MoveVelocity Function Block Diagram example

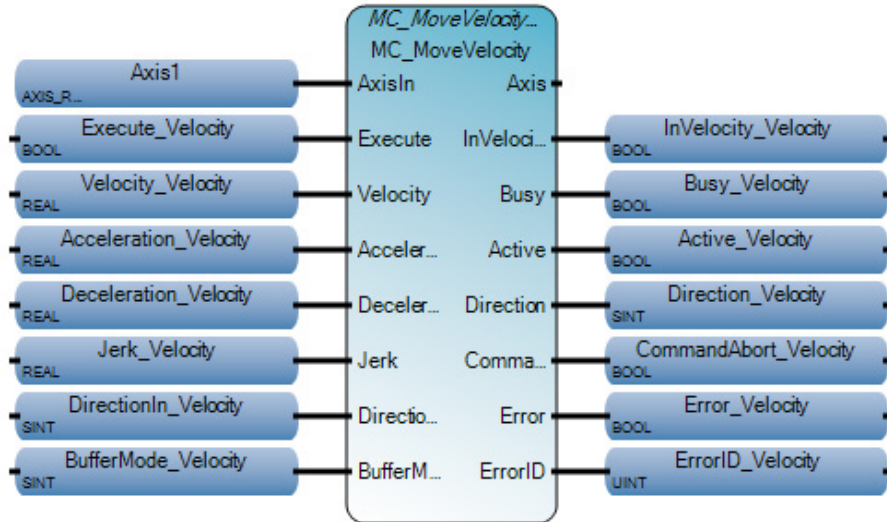

### MC\_MoveVelocity Ladder Diagram example

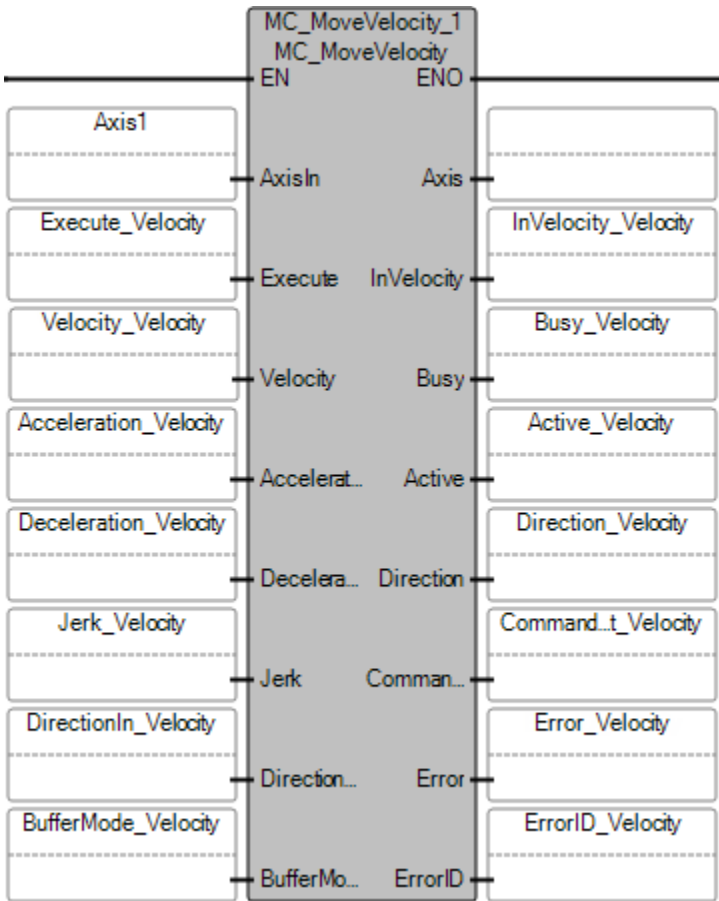

## MC\_MoveVelocity Structured Text example

```

MC_MoveVelocity_1(
void MC_MoveVelocity_1(AXIS_REF AxisIn, BOOL Execute, REAL Velocity, REAL Acceleration, REAL Deceleration, REAL Jerk, SINT DirectionIn, SINT BufferMode)
Type : MC_MoveVelocity, Commands a never ending controlled motion at a specified velocity.

Velocity_Velocity := 400.0;
Acceleration_Velocity := 100.0;
Deceleration_Velocity := 100.0;
Jerk_Velocity := 100.0;
DirectionIn_Velocity := 1;
MC_MoveVelocity_1(Axis1,Execute_Velocity,Velocity_Velocity,
Acceleration_Velocity,Deceleration_Velocity,Jerk_Velocity,DirectionIn_Velocity,BufferMode_Velocity);
InVelocity_Velocity := MC_MoveVelocity_1.InVelocity;
Busy_Velocity := MC_MoveVelocity_1.Busy;
Active_Velocity := MC_MoveVelocity_1.Active;
Direction_Velocity := MC_MoveVelocity_1.Direction;
CommandAbort_Velocity := MC_MoveVelocity_1.CommandAborted;
Error_Velocity := MC_MoveVelocity_1.Error;
ErrorID_Velocity := MC_MoveVelocity_1.ErrorID;
    
```

### Results

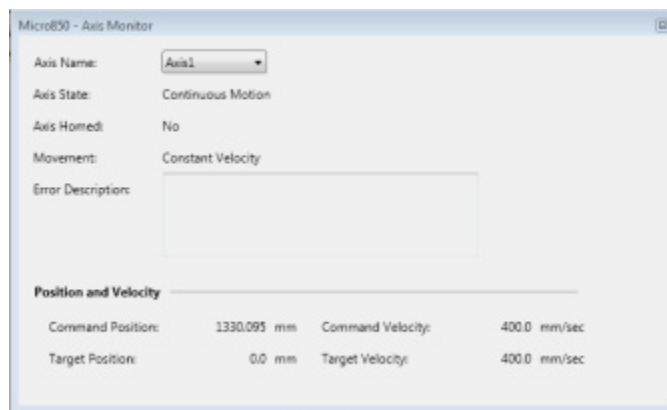

Name	Alias	Logical Value	Physical Value	Initial Value	Lock	Data Type	Dimension
Execute_Velocity		<input checked="" type="checkbox"/>	N/A		<input type="checkbox"/>	BOOL	
Velocity_Velocity		400.0	N/A		<input type="checkbox"/>	REAL	
Acceleration_Velocity		100.0	N/A		<input type="checkbox"/>	REAL	
Deceleration_Velocity		100.0	N/A		<input type="checkbox"/>	REAL	
Jerk_Velocity		100.0	N/A		<input type="checkbox"/>	REAL	
DirectionIn_Velocity		1	N/A		<input type="checkbox"/>	SINT	
BufferMode_Velocity		0	N/A		<input type="checkbox"/>	SINT	
InVelocity_Velocity		<input checked="" type="checkbox"/>	N/A		<input type="checkbox"/>	BOOL	
Busy_Velocity		<input type="checkbox"/>	N/A		<input type="checkbox"/>	BOOL	
Active_Velocity		<input type="checkbox"/>	N/A		<input type="checkbox"/>	BOOL	
Direction_Velocity		1	N/A		<input type="checkbox"/>	SINT	
CommandAbort_Velocity		<input type="checkbox"/>	N/A		<input type="checkbox"/>	BOOL	
Error_Velocity		<input type="checkbox"/>	N/A		<input type="checkbox"/>	BOOL	
ErrorID_Velocity		0	N/A		<input type="checkbox"/>	UINT	

## MC\_Power (motion control power)

Controls the power stage, ON or OFF.

Operation details:

- If you import a project created in CCW 7 into CCW 8, the Mc\_Power new input parameter, \_\_DTI\_AxisIn shows. If a Build error occurs, reselect the instruction and rebuild.
- After axis power On completes, the axis Homed status is reset to 0 (not homed).
- The Enable\_Positive input and the Enable\_Negative input for MC\_Power are both level triggered and are checked when the Enable input changes from OFF to ON. The on-the-fly change for the

- Enable\_Positive input and the Enable\_Negative input without Enable input toggling is not checked.
- If power fails during operation (when Servo ready has been detected) the axis state changes to ErrorStop.
  - The MC\_Power instruction has a time out value of 2 minutes. MC\_Power returns an error when the time out period expires and Drive Ready Input is FALSE.
  - If an MC\_Power function block with Enable set to True is called while the axis state is Disabled, the axis state changes to StandStill unless an error is detected, in which case the axis state changes to ErrorStop.
  - Only one MC\_Power function block should be issued per axis. If a different MC\_Power function block is used to control the same axis simultaneously, it is rejected by the Motion Engine.
  - When there is a Power On or Off state switch for an axis, the absolute axis position is not reset.
  - If an MC\_Power function block with Enable set to False is called, the axis state changes to Disabled for every state including ErrorStop.
  - The MC\_Power function block can power on the axis if Enable is set to True and power off the axis if Enable is set to False.

Languages supported: Function Block Diagram, Ladder Diagram, Structured Text.

This instruction applies to the Micro830, Micro850 and Micro870 controllers that support motion control.

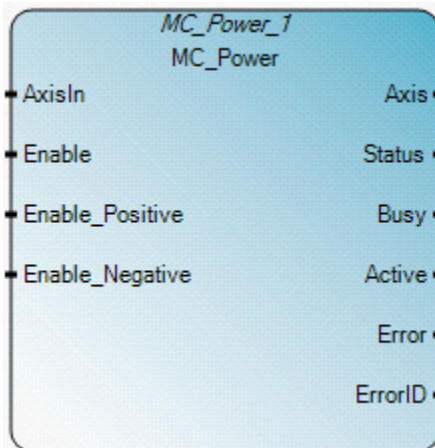

Use this table to help determine the parameter values for this instruction.

Parameter	Parameter type	Data type	Description
EN	Input	BOOL	Instruction block enable. TRUE - execute current MC_Power computation. FALSE - there is no computation. Applies only to Ladder Diagram programs.
AxisIn	Input	AXIS_REF FB_AXIS_REF	Use the <a href="#">AXIS_REF data type</a> on <a href="#">page 413</a> parameters to define AxisIn. For an FB.Axis (feedback axis), use the <a href="#">FB_AXIS_REF data type</a> on <a href="#">page 414</a> to define AxisIn.

Parameter	Parameter type	Data type	Description
Enable	Input	BOOL	TRUE - power is ON. FALSE - power is OFF
Enable_Positive	Input	BOOL	TRUE - motion is allowed in the positive direction.
Enable_Negative	Input	BOOL	TRUE - motion is allowed in the negative direction.
ENO	Output	BOOL	Enable output. Applies only to Ladder Diagram programs.
Axis	Output	AXIS_REF	Axis output is read-only in Ladder Diagram programs. AXIS_REF data type.
Status	Output	BOOL	State of the power stage: <ul style="list-style-type: none"> <li>• TRUE - drive power on is done.</li> <li>• FALSE - drive power on is not done.</li> </ul>
Busy	Output	BOOL	TRUE - the instruction block is not finished. FALSE - the instruction block is finished.
Active	Output	BOOL	TRUE - indicates the function block has control on the axis.
Error	Output	BOOL	Indicates an error occurred. TRUE - An error is detected. FALSE - No error.
ErrorID	Output	UINT	A unique numeric that identifies the error. The errors for this instruction are defined in <a href="#">Motion control function block error IDs</a> on <a href="#">page 411</a> .

### MC\_Power Function Block Diagram example

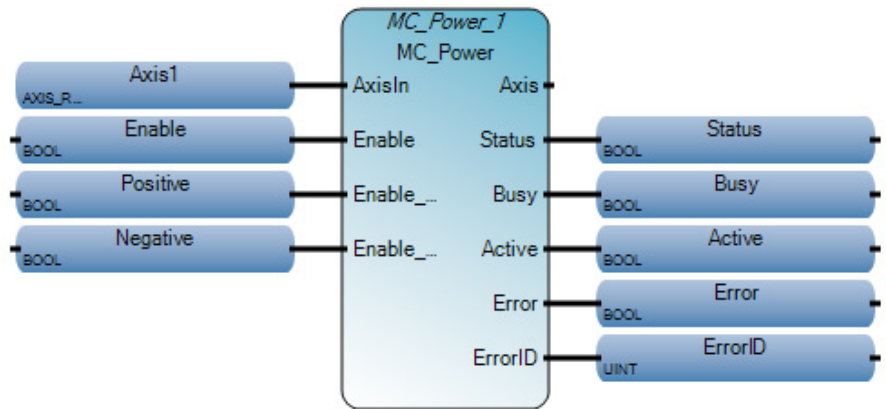

### MC\_Power Ladder Diagram example

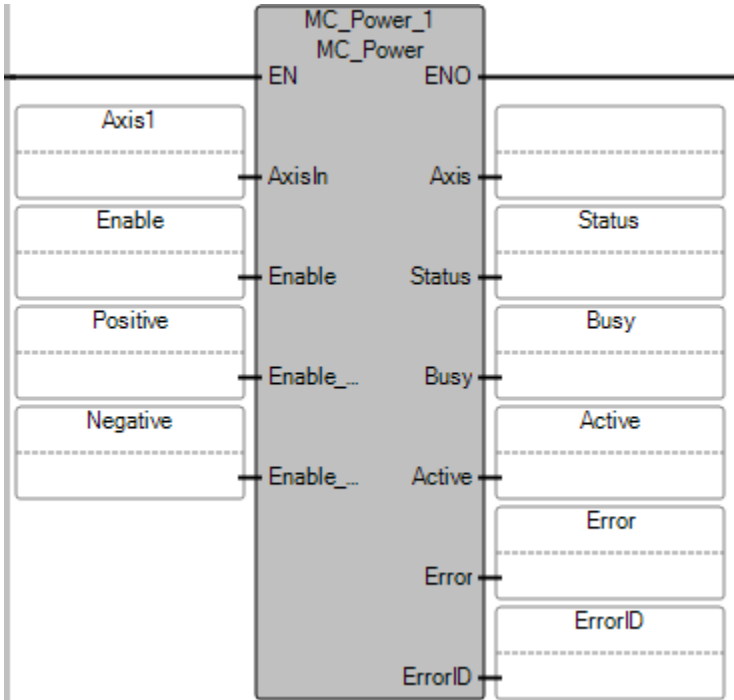

### MC\_Power Structured Text example

```
MC_Power_1(
void MC_Power_1(AXIS_REF AxisIn, BOOL Enable, BOOL Enable_Positive, BOOL Enable_Negative)
Type : MC_Power, Controls the power stage (On or Off)
```

```
Positive := True;
Negative := True;
MC_Power_1(Axis1, Enable, Positive, Negative);
Status := MC_Power_1.Status;
Busy := MC_Power_1.Busy;
Active := MC_Power_1.Active;
Error := MC_Power_1.Error;
ErrorID := MC_Power_1.ErrorID;
```

### Results

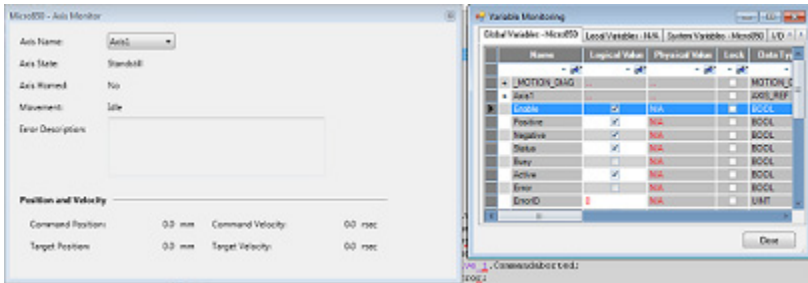

## MC\_ReadActualPosition (motion control read actual position)

Returns the actual position of the feedback axis. MC\_ReadActualPosition is only applicable to feedback motion.

Operation details:

- Before executing MC\_ReadActualPosition, verify the axis is in one of the following Axis States:
  - Disabled
  - Standstill
  - Discrete Motion
  - Error Stop
- The actual position for a feedback axis is not reset to 0 after a download. To reset or clear the position for a feedback axis use the MC\_Home instruction or MC\_SetPosition instruction.

Languages supported: Function Block Diagram, Ladder Diagram, Structured Text.

This instruction applies to the Micro830, Micro850 and Micro870 controllers that support motion control.

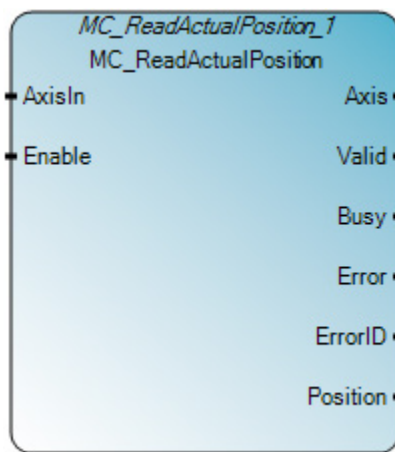

Use this table to help determine the parameter values for this instruction.

Parameter	Parameter type	Data type	Description
AxisIn	Input	FB_AXIS_REF	For an FB_Axis (feedback axis), use the <a href="#">FB_AXIS_REF data type</a> on <a href="#">page 414</a> to define AxisIn.
Enable	Input	BOOL	TRUE - get the value of the parameter continuously while enabled. FALSE - idle.
Axis	Output	FB_AXIS_REF	Axis output is read-only in Ladder Diagram programs. The Axis output parameters are defined in the FB_AXIS_REF data type.
Valid	Output	BOOL	TRUE - the instruction block is active and new output values are expected. FALSE - the instruction block is inactive.
Busy	Output	BOOL	TRUE - the instruction block is not finished. FALSE - the instruction block is finished.
Error	Output	BOOL	Indicates an error occurred. TRUE - An error is detected. FALSE - No error.



Parameter	Parameter type	Data type	Description
ErrorID	Output	UNIT	A unique numeric that identifies the error. The errors for this instruction are defined in <a href="#">Motion control function block error IDs</a> on <a href="#">page 411</a> .
Position	Output	REAL	The value of the actual absolute position for feedback motion Axis. (in axis' unit [u])

**MC\_ReadActualPosition Function Block Diagram example**

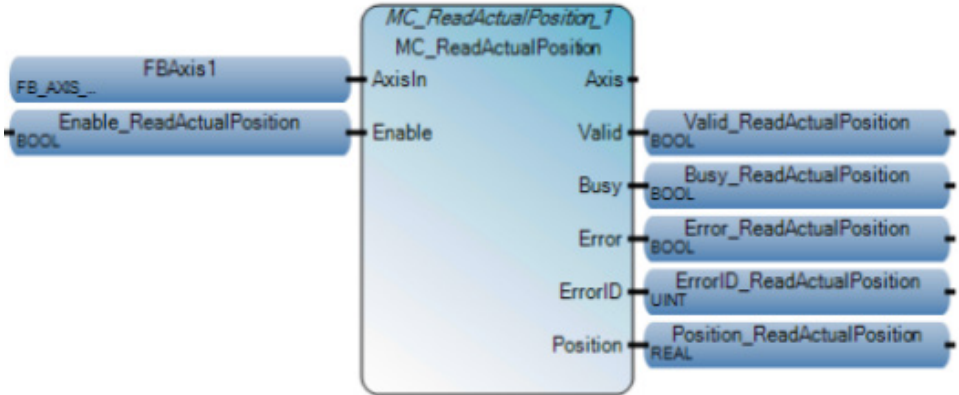

**MC\_ReadActualPosition Ladder Diagram example**

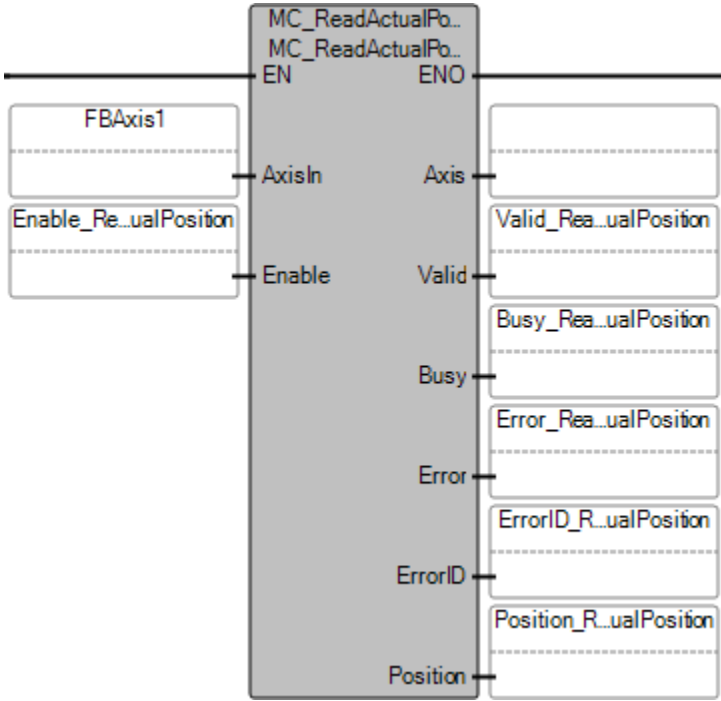

## MC\_ReadActualPosition Structured Text example

```
void MC_ReadActualPosition_1(  
void MC_ReadActualPosition_1(FB_AXIS_REF AxisIn, BOOL Enable)  
Type: MC_ReadActualPosition, Returns the actual position for an axis  
  
MC_ReadActualPosition_1(FBAxis, Enable_ReadActualPosition)  
Valid_ReadActualPosition := MC_ReadActualPosition_1.Valid  
Busy_ReadActualPosition := MC_ReadActualPosition_1.Busy  
Error_Valid_ReadActualPosition := MC_ReadActualPosition_1.Error  
ErrorID_Valid_ReadActualPosition := MC_ReadActualPosition_1.ErrorID  
Position_Valid_ReadActualPosition := MC_ReadActualPosition_1.Position
```

### Results

**Micro830 - Axis Monitor**

Axis Name: FBAxis1

Axis State: Discrete Motion

Movement: Accelerating

Error Description:

---

**Position and Velocity**

Actual Position: 26169.91 mm    Actual Velocity: 24.39024 mm/sec

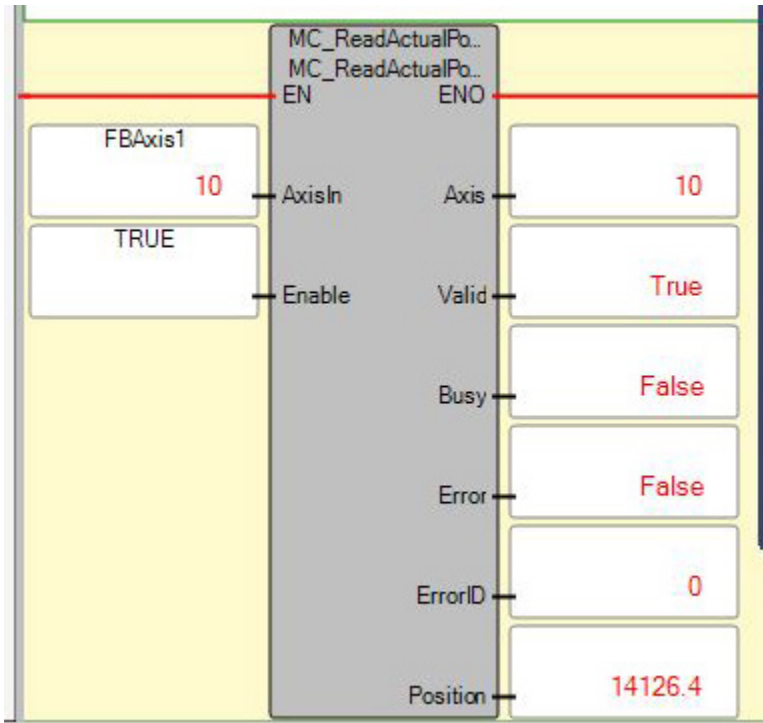

Name	Alias	Logical Value
- MC_ReadActualPosition_2		...
+ MC_ReadActualPosition_2.AxisIn	Axis	...
MC_ReadActualPosition_2.Enable	En	<input checked="" type="checkbox"/>
+ MC_ReadActualPosition_2.Axis	Axis	...
MC_ReadActualPosition_2.Valid	Val	<input checked="" type="checkbox"/>
MC_ReadActualPosition_2.Busy	Busy	<input type="checkbox"/>
MC_ReadActualPosition_2.Error	Err	<input type="checkbox"/>
MC_ReadActualPosition_2.ErrorID	ErrID	0
MC_ReadActualPosition_2.Position	Pos	14126.3945

## MC\_ReadActualVelocity (motion control read actual velocity)

Returns the value of the actual velocity of the feedback axis.

MC\_ReadActualVelocity is only applicable to feedback motion.

Before executing MC\_ReadActualVelocity, verify the axis is in one of the following Axis States:

- Standstill
- Discrete Motion
- Error Stop

Languages supported: Function Block Diagram, Ladder Diagram, Structured Text.

This instruction applies to the Micro830, Micro850 and Micro870 controllers that support motion control.

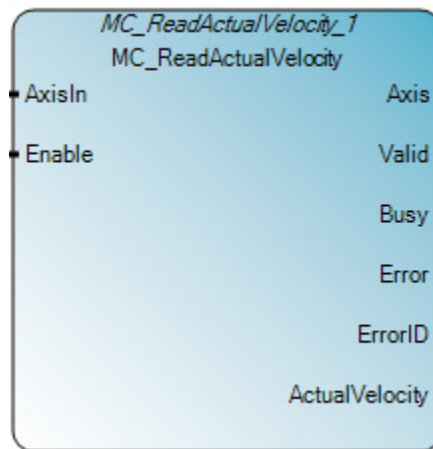

Use this table to help determine the parameter values for this instruction.

Parameter	Parameter type	Data type	Description
AxisIn	Input	FB_AXIS_REF	For an FB_Axis (feedback axis), use the FB_AXIS_REF data type to define AxisIn.
Enable	Input	BOOL	TRUE - get the value for the actual velocity continuously. FALSE - the data is no longer valid, all outputs are reset to 0, Valid is set to False.
Axis	Output	FB_AXIS_REF	Axis output is read-only in Ladder Diagram programs. The Axis output parameters are defined in the <a href="#">FB_AXIS_REF data type</a> on <a href="#">page 414</a> .
Valid	Output	BOOL	TRUE - the function block is active and new output values are expected. FALSE - the function is not expecting new output values.
Busy	Output	BOOL	TRUE - the function block is not finished. FALSE - the function is idle.
Error	Output	BOOL	Indicates an error occurred. TRUE - An error is detected. FALSE - No error.
ErrorID	Output	UNIT	A unique numeric that identifies the error. The errors for this instruction are defined in <a href="#">Motion control function block error IDs</a> on <a href="#">page 411</a> .
ActualVelocity	Output	REAL	The value of the actual velocity for the feedback motion axis (in axis' unit [u/s]). ActualVelocity is a signed value, which includes direction information.

### MC\_ReadActualVelocity Function Block Diagram example

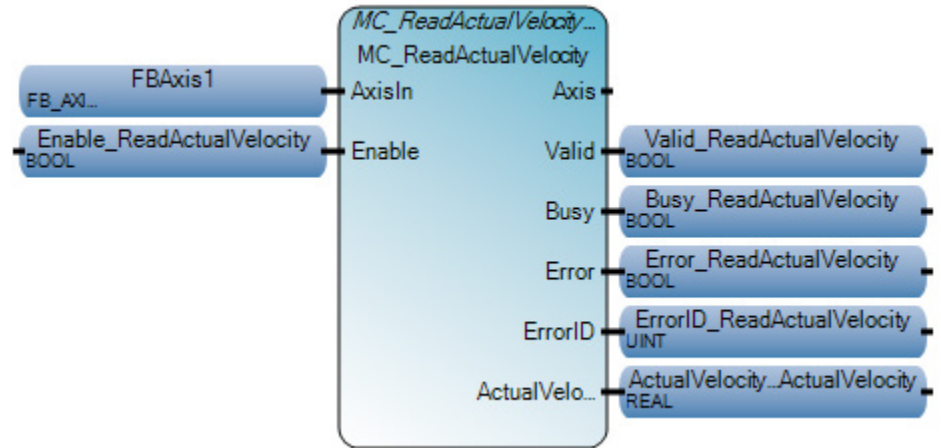

### MC\_ReadActualVelocity Ladder Diagram example

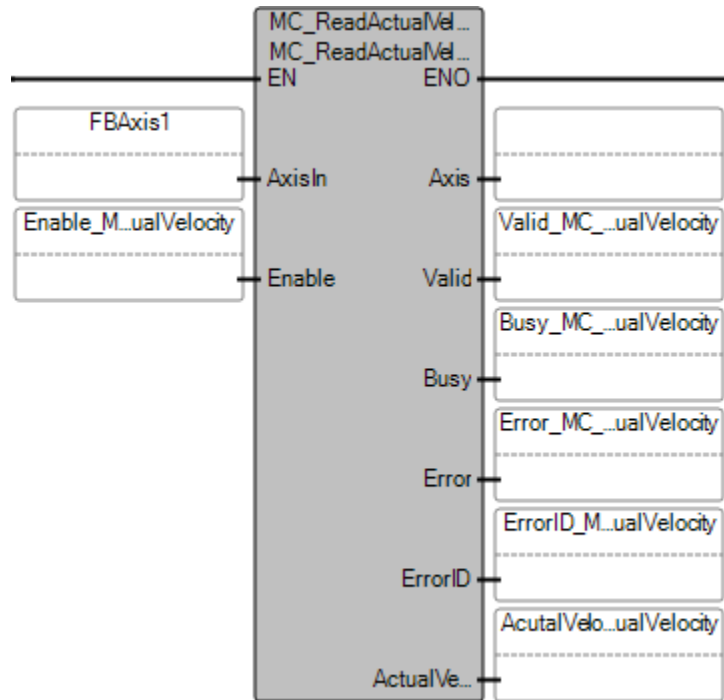

## MC\_ReadActualVelocity Structured Text example

```
void MC_ReadActualVelocity_1(  
    void MC_ReadActualVelocity_1(FB_AXIS_REF AxisIn, BOOL Enable)  
    Type: MC_ReadActualVelocity, Returns the actual velocity for an axis  
  
    MC_ReadActualVelocity_1(FBAxis1, Enable_ReadActualVelocity)  
    Valid_ReadActualVelocity := MC_ReadActualVelocity_1.Valid  
    Busy_ReadActualVelocity := MC_ReadActualVelocity_1.Busy  
    Error_ReadActualVelocity := MC_ReadActualVelocity_1.Error  
    ErrorID_ReadActualVelocity := MC_ReadActualVelocity_1.ErrorID  
    Position_ReadActualVelocity := MC_ReadActualVelocity_1.ErrorID
```

Results

Micro830 - Axis Monitor

Axis Name: FBAxis1

Axis State: Discrete Motion

Movement: Accelerating

Error Description:

---

**Position and Velocity**

Actual Position: 16611.12 mm      Actual Velocity: 25.12563 mm/sec

MC\_ReadActualVel...  
MC\_ReadActualVel...  
EN      ENO

FBAxis1 10 — AxisIn      Axis — 10

TRUE — Enable      Valid — True

Busy — False

Error — False

ErrorID — 0

ActualVe... — 24.1546

Name	Alias	Logical Value
MC_ReadActualVelocity_1		...
MC_ReadActualVelocity_1.AxisIn	Axis	...
MC_ReadActualVelocity_1.Enable	En	<input checked="" type="checkbox"/>
MC_ReadActualVelocity_1.Axis	Axis	...
MC_ReadActualVelocity_1.Valid	Val	<input checked="" type="checkbox"/>
MC_ReadActualVelocity_1.Busy	Busy	<input type="checkbox"/>
MC_ReadActualVelocity_1.Error	Err	<input type="checkbox"/>
MC_ReadActualVelocity_1.ErrorID	ErrID	0
MC_ReadActualVelocity_1.ActualVelocity	Velo	24.1545887

**MC\_ReadAxisError (motion control read axis error)**

Reads the axis errors not related to the Motion control instruction blocks. When an axis is in a Disabled state, MC\_ReadAxisError may or may not get a non-zero Error ID for the axis because a Disabled axis can contain errors or

be error-free.

Languages supported: Function Block Diagram, Ladder Diagram, Structured Text.

This instruction applies to the Micro830, Micro850 and Micro870 controllers that support motion control.

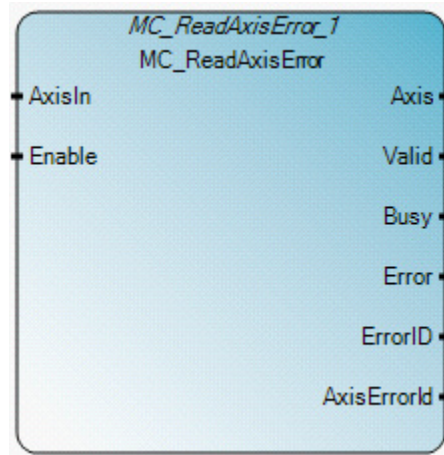

Use this table to help determine the parameter values for this instruction.

Parameter	Parameter type	Data type	Description
EN	Input	BOOL	Instruction block enable. TRUE - execute current MC_ReadAxisError computation. FALSE - Error, ErrorID, and AxisErrorID are reset to False(or 0). Applies only to LD programs.
AxisIn	Input	AXIS_REF FB_AXIS_REF	Use the <a href="#">AXIS_REF data type</a> on <a href="#">page 413</a> parameters to define AxisIn. For an FB_Axis (feedback axis), use the FB_AXIS_REF data type to define AxisIn.
Enable	Input	BOOL	TRUE - get the value of the parameter continuously while enabled. FALSE - resets Error, ErrorID, and AxisErrorID outputs to 0.
ENO	Output	BOOL	Enable output. Applies only to Ladder Diagram programs.
Axis	Output	AXIS_REF	Axis output is read-only in Ladder Diagram programs. The Axis output parameters are defined in the <a href="#">FB_AXIS_REF data type</a> on <a href="#">page 414</a> .
Valid	Output	BOOL	TRUE - the instruction block is active and new output values are expected. FALSE - the instruction block is inactive.
Busy	Output	BOOL	TRUE - the instruction block is not finished. FALSE - the instruction block is finished.
Error	Output	BOOL	Indicates an error occurred. TRUE - An error is detected. FALSE - No error.
ErrorID	Output	UINT	A unique numeric that identifies the error. The errors for this instruction are defined in Motion control function block error IDs.
AxisErrorID	Output	UINT	A unique numeric that identifies the axis error. The errors for this instruction are defined in <a href="#">AxisErrorID error codes</a> on <a href="#">page 450</a> .



### MC\_ReadAxisError Function Block Diagram example

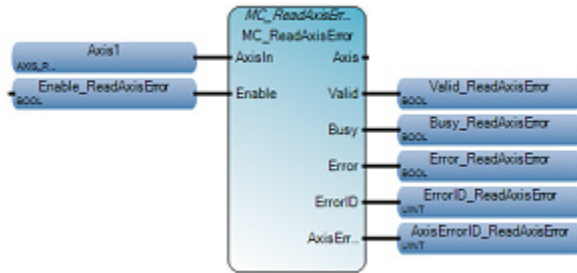

### MC\_ReadAxisError Ladder Diagram example

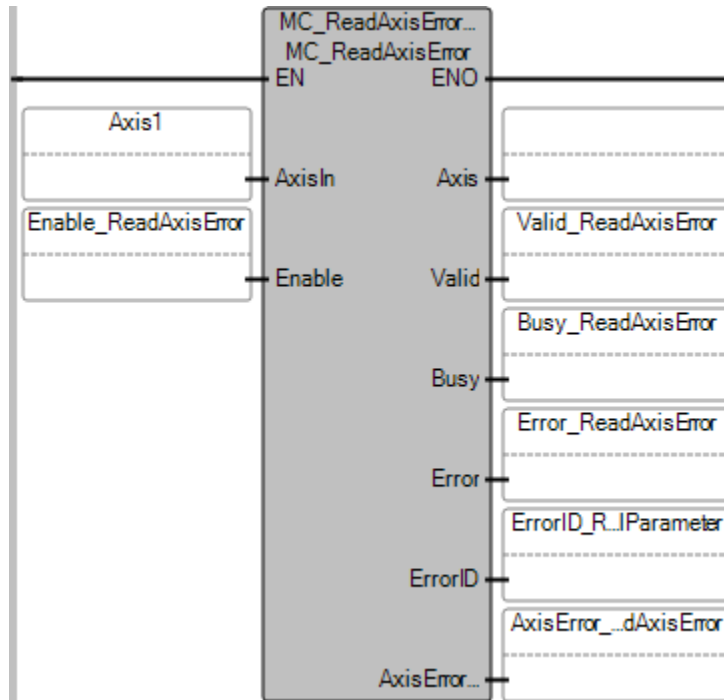

### MC\_ReadAxisError Structured Text example

```
MC_ReadAxisError_1 (
void MC_ReadAxisError_1 (AXIS_REF AxisIn, BOOL Enable)
Type : MC_ReadAxisError, Reads the error information for an axis
```

```
MC_ReadAxisError_1 (Axis1, Enable_ReadAxisError);
Valid_ReadAxisError := MC_ReadAxisError_1.Valid;
Busy_ReadAxisError := MC_ReadAxisError_1.Busy;
Error_ReadAxisError := MC_ReadAxisError_1.Error;
ErrorID_ReadAxisError := MC_ReadAxisError_1.ErrorID;
AxisErrorID_ReadAxisError := MC_ReadAxisError_1.AxisErrorID;
```

## Results

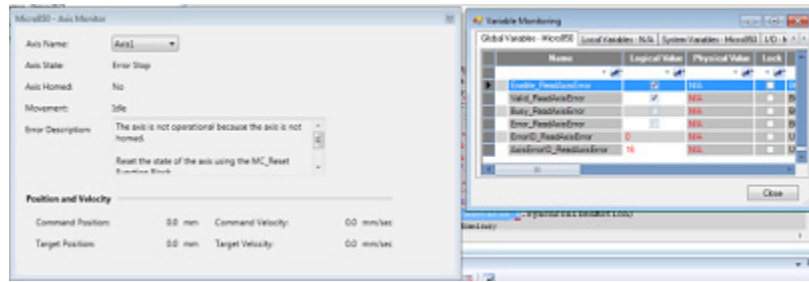

### AxisErrorID error codes

The following table describes the Axis error codes identified in the AxisErrorID for [MC\\_ReadAxisError](#) on [page 447](#).

Value	MACRO ID	Description
00	MC_FB_ERR_NO	The axis is in an operational state (nothing to display).
01	MC_FB_ERR_WRONG_STATE	The axis is not operational because an incorrect axis state was detected during a function block execution. Reset the state of the axis using the MC_Power and MC_Reset function blocks.
02	MC_FB_ERR_RANGE	The axis is not operational because an invalid axis dynamic parameter (velocity, acceleration, deceleration, or jerk) is set in a function block. Reset the state of the axis using the MC_Power and MC_Reset function blocks. In the function block, correct any setting for the dynamic parameters that conflict with the settings on the Axis Dynamics configuration page.
03	MC_FB_ERR_PARAM	The axis is not operational because an invalid parameter, (other than velocity, acceleration, deceleration, or jerk), is set in a function block. Reset the state of the axis using the MC_Power and MC_Reset function blocks. In the function block, correct the settings for the parameters, such as mode or position.
04	MC_FB_ERR_AXISNUM	Motion internal Fault, Error ID = 0x04. Contact your local Rockwell Automation technical support representative. For contact information, see: <a href="http://www.rockwellautomation.com/support">http://www.rockwellautomation.com/support</a>
05	MC_FB_ERR_MECHAN	The axis is not operational because a drive or mechanical issue was detected. Check the connection between the drive and the controller (Drive Ready and In-Position signals), and ensure the drive is operating normally. Reset the state of the axis using the MC_Power and MC_Reset function blocks.
06	MC_FB_ERR_NOPOWER	The axis is not powered on. Power on the axis using MC_Power function block. Reset the state of the axis using the MC_Reset function block.
07	MC_FB_ERR_RESOURCE	The axis is not operational because it or its related resources required by a function block are under the control of other function block, or not available. Ensure the axis or its related resources required by the function block are available for use. Reset the state of the axis using the MC_Power and MC_Reset function blocks. Review and correct the application if there are multiple instances of the same function block trying to control the axis at the same time.
08	MC_FB_ERR_PROFILE	The axis is not operational because the motion profile defined in a function block is invalid. Reset the state of the axis using the MC_Power and MC_Reset function blocks. Correct the profile in the function block.

Value	MACRO ID	Description
09	MC_FB_ERR_VELOCITY	The axis is not operational because the motion profile requested in a function block conflicts with the current axis velocity. Possible causes: <ul style="list-style-type: none"> <li>• The function block requests the axis to reverse the direction while the axis is moving.</li> <li>• The current velocity is too low or too high for the requested motion profile.</li> </ul> Reset the state of the axis using the MC_Power and MC_Reset function blocks. Correct the motion profile in the function block, or re-execute the function block when the axis velocity is compatible with the requested motion profile.
10	MC_FB_ERR_SOFT_LIMIT	The axis is not operational because a Soft Limit error was detected, or executing the function block would cause a Soft Limit error. Reset the state of the axis using the MC_Power and MC_Reset function blocks. Check the velocity or target position settings for the function block, or adjust Soft Limit setting.
11	MC_FB_ERR_HARD_LIMIT	The axis is not operational because a Hard Limit error was detected. Reset the state of the axis using the MC_Reset function block, and then move the axis away from the Hard Limit switch in the opposite direction.
12	MC_FB_ERR_LOG_LIMIT	The axis is not operational because a PTO Accumulator logic limit error was detected, or executing the function block would cause a PTO Accumulator logic limit error. Reset the state of the axis using the MC_Power and MC_Reset function blocks. Check the velocity or target position settings for the function block. Use the MC_SetPosition function block to adjust the axis coordinate system.
13	MC_FB_ERR_ERR_ENGINE	The axis is not operational because a motion engine execution error was detected. Power cycle the entire machine and download the User Application to the controller again. If the fault persists, contact your local Rockwell Automation technical support representative. For contact information, see: <a href="http://www.rockwellautomation.com/support">http://www.rockwellautomation.com/support</a> .
16	MC_FB_ERR_NOT_HOMED	The axis is not operational because the axis is not homed. Reset the state of the axis using the MC_Power and MC_Reset function blocks. Execute homing against the axis using MC_Home function block.
128	MC_FB_ERR_PARAM_MODIFIED	Motion internal warning, Warning ID = 0x80. Contact your local Rockwell Automation technical support representative. For contact information, see: <a href="http://www.rockwellautomation.com/support">http://www.rockwellautomation.com/support</a> .

## MC\_ReadBoolParameter (motion control read BOOL parameter)

Returns the value of a vendor specific parameter of type BOOL.

Languages supported: Function Block Diagram, Ladder Diagram, Structured Text.

This instruction applies to the Micro830, Micro850 and Micro870 controllers that support motion control.

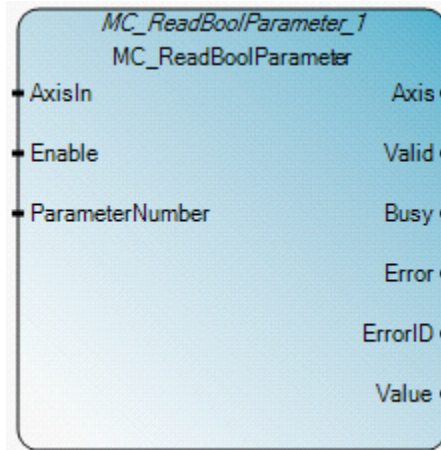

Use this table to help determine the parameter values for this instruction.

Parameter	Parameter type	Data type	Description
EN	Input	BOOL	Instruction block enable. TRUE - execute current MC_ReadBoolParameter computation. FALSE - reset Value output to 0. Applies only to Ladder Diagram programs.
AxisIn	Input	AXIS_REF FB_AXIS_REF	Use the <a href="#">AXIS_REF data type</a> on <a href="#">page 413</a> to define AxisIn. For FB.Axis (feedback axis), use the <a href="#">FB_AXIS_REF data type</a> on <a href="#">page 414</a> to define AxisIn.
Enable	Input	BOOL	TRUE - get the value of the parameter continuously while enabled. FALSE - the Value output is reset to 0.
ParameterNumber	Input	DINT	Parameter identification. Parameter numbers definitions are defined in Motion control function block parameter numbers.
ENO	Output	BOOL	Enable output. Applies only to Ladder Diagram programs.
Axis	Output	AXIS_REF	Axis output is read-only in Ladder Diagram programs.
Valid	Output	BOOL	TRUE - the value of the Parameter is available. FALSE - the Parameter value is unavailable.
Busy	Output	BOOL	TRUE - the function block is working and new output values are expected. FALSE - the function is idle.
Error	Output	BOOL	Indicates an error occurred. TRUE - An error is detected. FALSE - No error.
ErrorID	Output	UINT	A unique numeric that identifies the error. The errors for this instruction are defined in <a href="#">Motion control function block error IDs</a> on <a href="#">page 411</a> .
Value	Output	BOOL	Value of the specified parameter in the data type, as specified by the vendor.

### MC\_ReadBoolParameter Function Block Diagram example

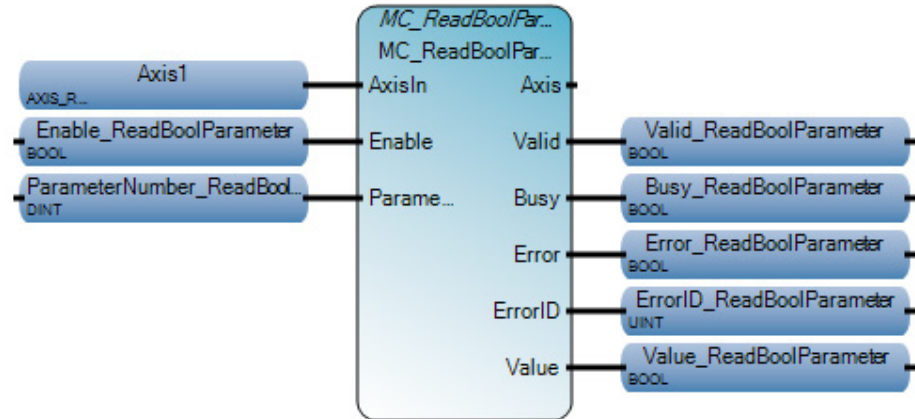

### MC\_ReadBoolParameter Ladder Diagram example

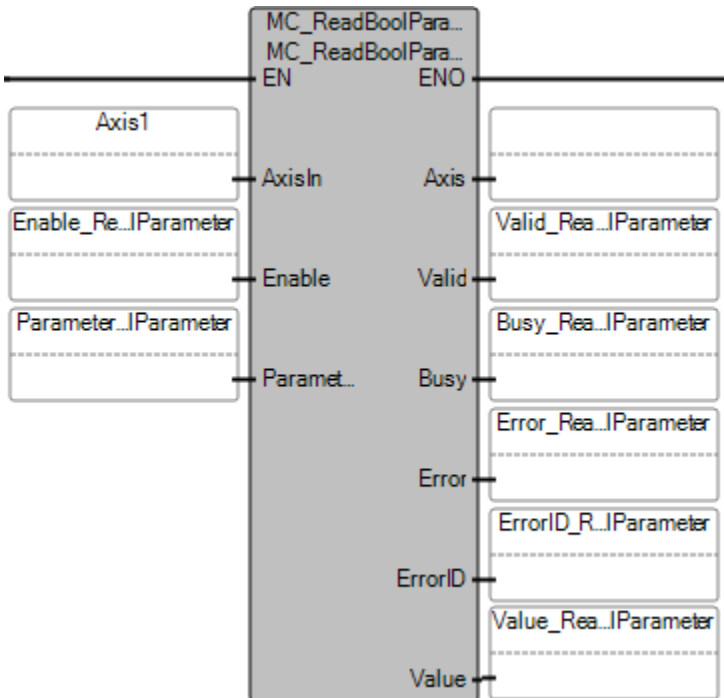

### MC\_ReadBoolParameter Structured Text example

```

MC_ReadBoolParameter_1(
void MC_ReadBoolParameter_1(AXIS_REF AxisIn, BOOL Enable, DINT ParameterNumber)
Type : MC_ReadBoolParameter, Returns the value of a motion specific BOOL parameter.

ParameterNumber_ReadBoolParameter := 4;
MC_ReadBoolParameter_1(Axis1, Enable_ReadBoolParameter, ParameterNumber_ReadBoolParameter);
Valid_ReadBoolParameter := MC_ReadBoolParameter_1.Valid;
Busy_ReadBoolParameter := MC_ReadBoolParameter_1.Busy;
Error_ReadBoolParameter := MC_ReadBoolParameter_1.Error;
ErrorID_ReadBoolParameter := MC_ReadBoolParameter_1.ErrorID;
Value_ReadBoolParameter := MC_ReadBoolParameter_1.Value;

```

## Results

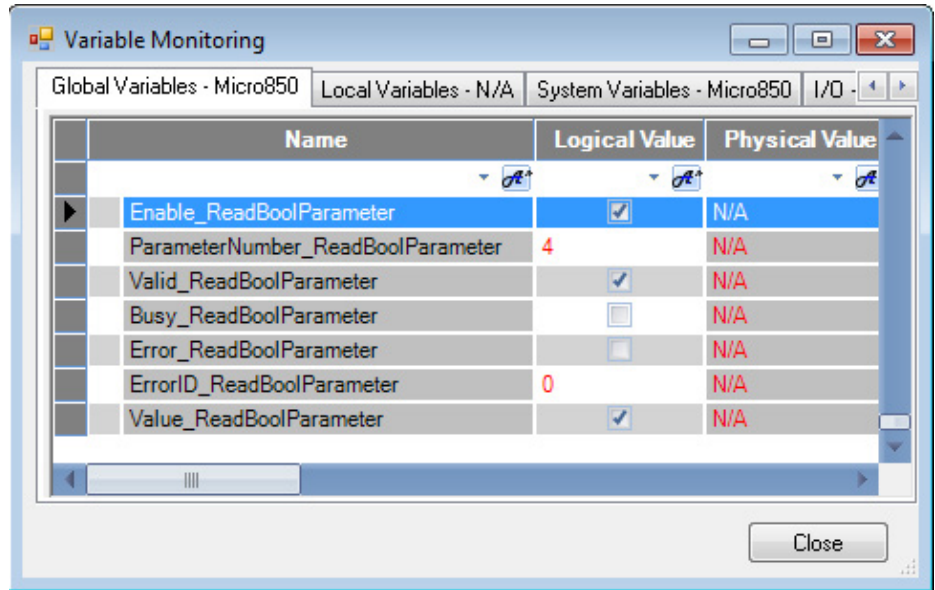

### MC\_ReadParameter (motion control read parameter)

Returns the value of a vendor specific parameter in a Real data type.

Languages supported: Function Block Diagram, Ladder Diagram, Structured Text.

This instruction applies to the Micro830, Micro850 and Micro870 controllers that support motion control.

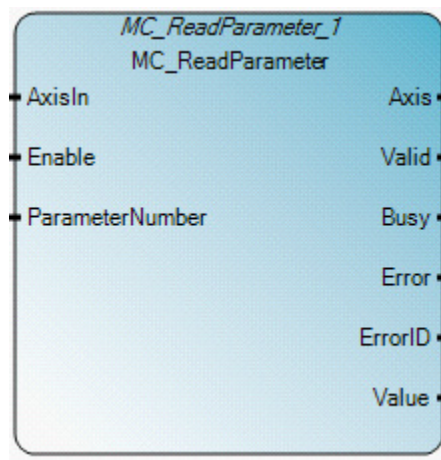

Use this table to help determine the parameter values for this instruction.

Parameter	Parameter type	Data type	Description
EN	Input	BOOL	Instruction block enable. TRUE - execute current MC_ReadParameter computation. FALSE - the Value output is reset to 0. Applies only to Ladder Diagram programs.
AxisIn	Input	AXIS_REF FB_AXIS_REF	Use the <a href="#">AXIS_REF data type</a> on <a href="#">page 413</a> to define AxisIn. For FB_Axis (feedback axis), use the <a href="#">FB_AXIS_REF data type</a> on <a href="#">page 414</a> to define AxisIn.
Enable	Input	BOOL	TRUE - get the value of the parameter number continuously. FALSE - the Value output is reset to 0.

Parameter	Parameter type	Data type	Description
ParameterNumber	Input	DINT	Parameter identification. Parameter numbers definitions are defined in Motion control function block parameter numbers.
ENO	Output	BOOL	Enable output. Applies only to Ladder Diagram programs.
Axis	Output	AXIS_REF	Axis output is read-only in Ladder Diagram programs.
Valid	Output	BOOL	TRUE - valid outputs are available. FALSE - valid outputs are unavailable.
Busy	Output	BOOL	TRUE - the function block is working and new output values are expected. FALSE - the function block is idle.
Error	Output	BOOL	Indicates an error occurred. TRUE - An error is detected. FALSE - No error.
ErrorID	Output	UINT	A unique numeric that identifies the error. The errors for this instruction are defined in <a href="#">Motion control function block error IDs</a> on <a href="#">page 411</a> .
Value	Output	REAL	Value of the specified parameter in the data type, as specified by the vendor.

**MC\_ReadParameter Function Block Diagram example**

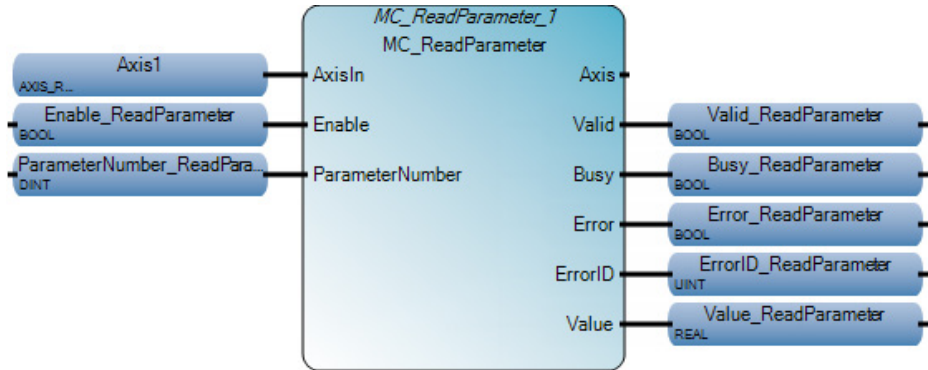

### MC\_ReadParameter Ladder Diagram example

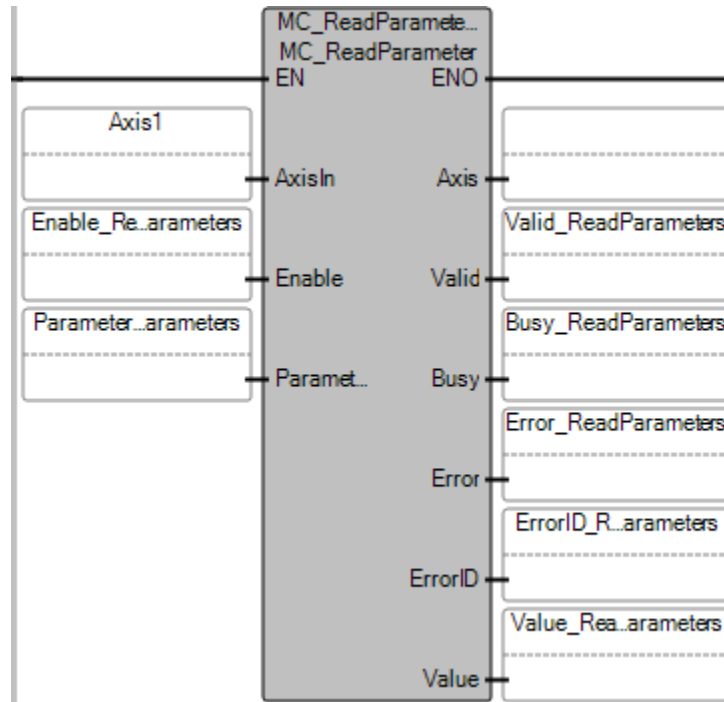

### MC\_ReadParameter Structured Text example

```

MC_ReadParameter 1
void MC_ReadParameter_1(Axis_REF AxisIn, BOOL Enable, DINT ParameterNumber)
Type : MC_ReadParameter, Returns the value of a motion specific REAL parameter.

ParameterNumber_ReadParameter := 11;
MC_ReadParameter_1(Axis1, Enable_ReadParameter, ParameterNumber_ReadParameter);
Valid_ReadParameter := MC_ReadParameter_1.Valid;
Busy_ReadParameter := MC_ReadParameter_1.Busy;
Error_ReadParameter := MC_ReadParameter_1.Error;
ErrorID_ReadParameter := MC_ReadParameter_1.ErrorID;
Value_ReadParameter := MC_ReadParameter_1.Value;
    
```

### Results

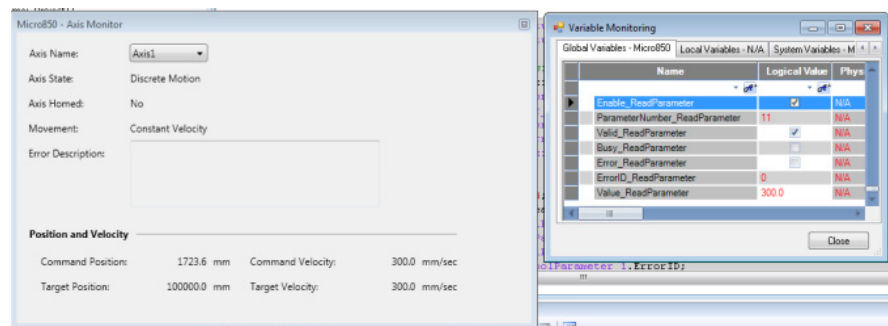

### MC\_ReadStatus (motion control read status)

Returns the status of the axis with respect to the motion currently in progress.

Languages supported: Function Block Diagram, Ladder Diagram, Structured Text.



This instruction applies to the Micro830, Micro850 and Micro870 controllers that support motion control.

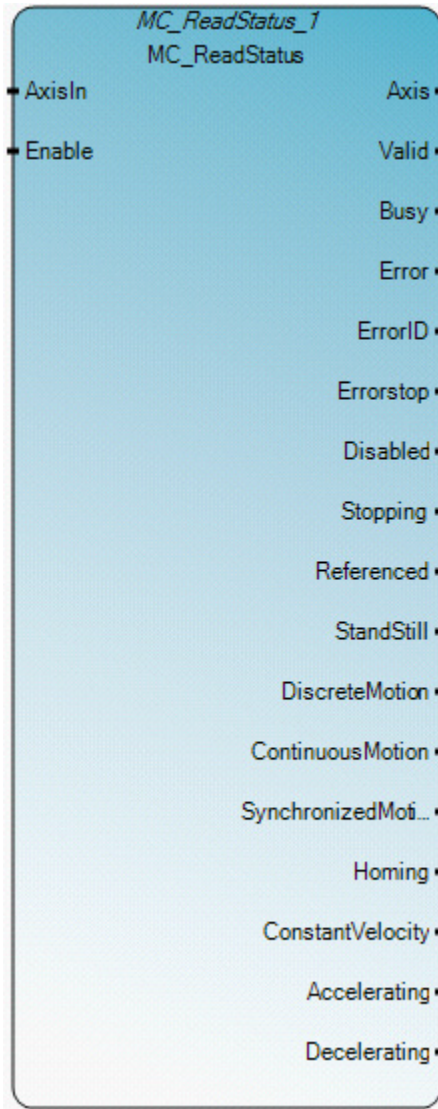

Use this table to help determine the parameter values for this instruction.

Parameter	Parameter type	Data type	Description
EN	Input	BOOL	Instruction block enable. TRUE - execute current MC_ReadStatus computation. FALSE - there is no computation. Applies only to Ladder Diagram programs.
AxisIn	Input	AXIS_REF FB_AXIS_REF	Use the <a href="#">AXIS_REF data type</a> on <a href="#">page 413</a> parameters to define AxisIn. For an FB_Axis (feedback axis), use the <a href="#">FB_AXIS_REF data type</a> on <a href="#">page 414</a> to define AxisIn.
Enable	Input	BOOL	TRUE - get the axis status continuously. FALSE - all status outputs are reset to 0.
ENO	Output	BOOL	Enable output. Applies only to Ladder Diagram programs.
Axis	Output	AXIS_REF	Axis output is read-only in Ladder Diagram programs.
Valid	Output	BOOL	TRUE - valid outputs are available. FALSE - outputs unavailable.

Parameter	Parameter type	Data type	Description
Busy	Output	BOOL	TRUE - the function block is working and new output values are expected. FALSE - the function block is idle.
Error	Output	BOOL	Indicates an error occurred. TRUE - An error is detected. FALSE - No error.
ErrorID	Output	UINT	A unique numeric that identifies the error. The errors for this instruction are defined in Motion control function block error IDs.
ErrorStop	Output	BOOL	TRUE - the axis state is ErrorStop. Axis states are defined in Motion control axis state values and names.
Disabled	Output	BOOL	TRUE - the axis state is Disabled.
Stopping	Output	BOOL	TRUE - the axis state is Stopping.
Referenced	Output	BOOL	TRUE - the axis state is homed, the absolute reference position is known for the axis.
StandStill	Output	BOOL	TRUE - the axis state is StandStill.
DiscreteMotion	Output	BOOL	TRUE - the axis state is DiscreteMotion.
ContinuousMotion	Output	BOOL	TRUE - the axis state is ContinuousMotion.
SynchronizedMotion	Output	BOOL	Synchronized motion is not supported in Micro800 controllers. TRUE - never true. FALSE - always false.
Homing	Output	BOOL	TRUE - the axis state is Homing.
ConstantVelocity	Output	BOOL	TRUE - the velocity for the motor is constant.
Accelerating	Output	BOOL	TRUE - axis is accelerating, increased energy to the motor.
Decelerating	Output	BOOL	TRUE - axis is decelerating, decreased energy to the motor.

### MC\_ReadStatus Function Block Diagram example

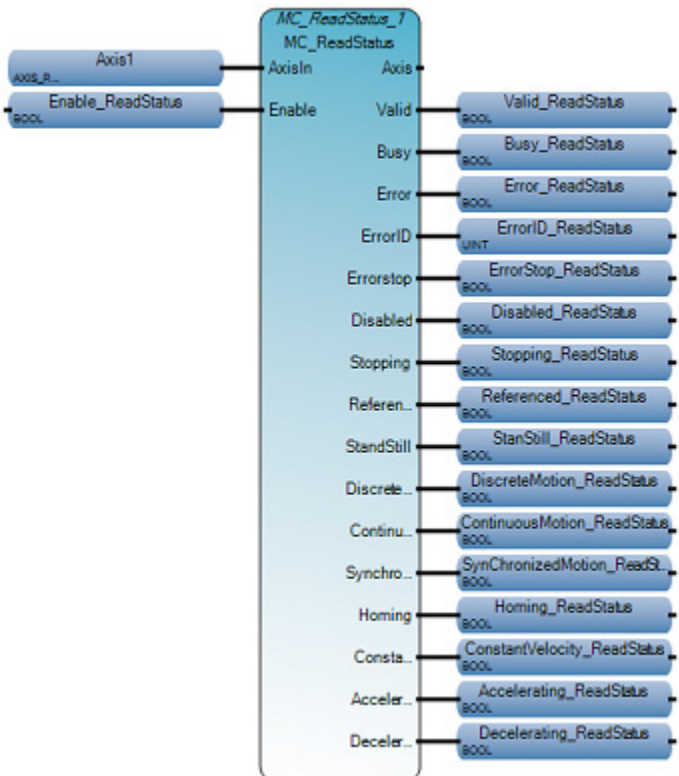

### MC\_ReadStatus Ladder Diagram example

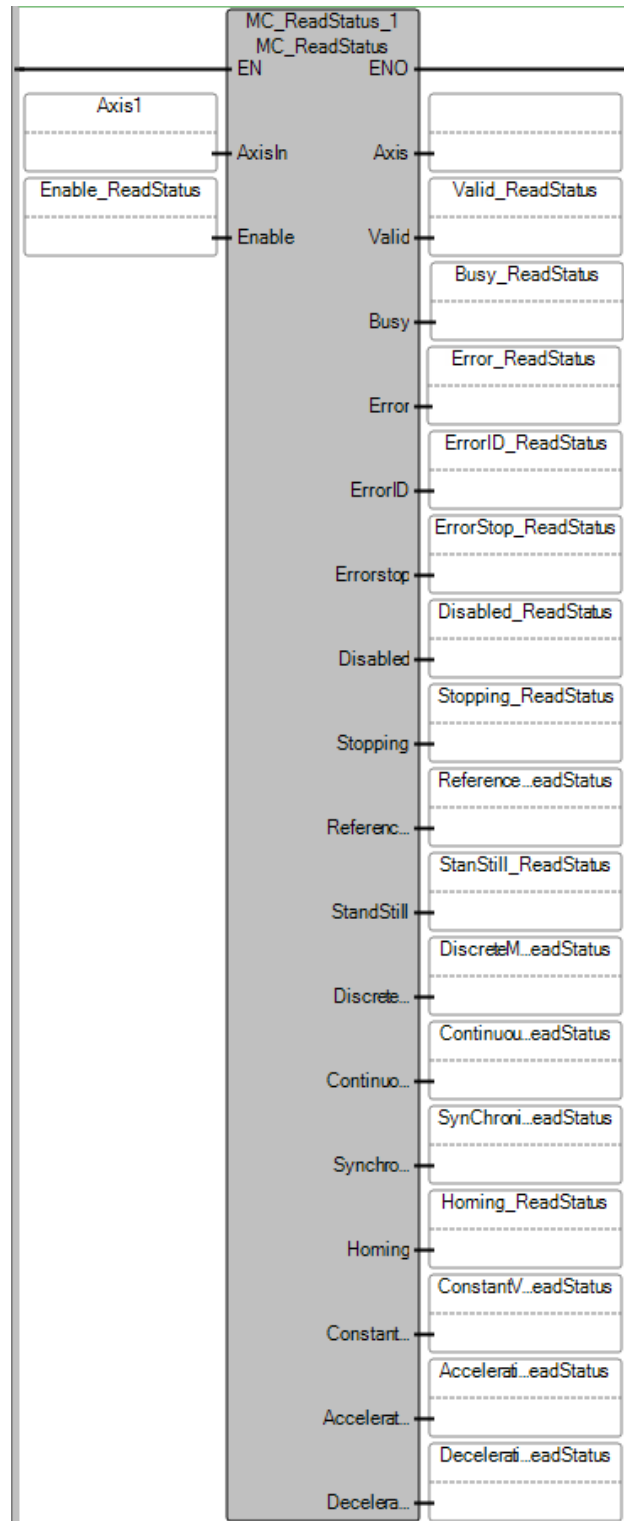

## MC\_ReadStatus Structured Text example

```

MC_ReadStatus_1 (
void MC_ReadStatus_1(AXIS_REF AxisIn, BOOL Enable)
Type : MC_ReadStatus, Returns in detail the status of the axis with respect to the motion currently in progress.

MC_ReadStatus_1(Axis1, Enable_ReadStatus);
Valid_ReadStatus := MC_ReadStatus_1.Valid;
Busy_ReadStatus := MC_ReadStatus_1.Busy;
Error_ReadStatus := MC_ReadStatus_1.Error;
ErrorID_ReadStatus := MC_ReadStatus_1.ErrorID;
ErrorStop_ReadStatus := MC_ReadStatus_1.Errorstop;
Disabled_ReadStatus := MC_ReadStatus_1.Disabled;
Stopping_ReadStatus := MC_ReadStatus_1.Stopping;
Referenced_ReadStatus := MC_ReadStatus_1.Referenced;
StandStill_ReadStatus := MC_ReadStatus_1.StandStill;
DiscreteMotion_ReadStatus := MC_ReadStatus_1.DiscreteMotion;
ContinuousMotion_ReadStatus := MC_ReadStatus_1.ContinuousMotion;
SynChronizedMotion_ReadStatus := MC_ReadStatus_1.SynchronizedMotion;
Homing_ReadStatus := MC_ReadStatus_1.Homing;
ConstantVelocity_ReadStatus := MC_ReadStatus_1.ConstantVelocity;
Accelerating_ReadStatus := MC_ReadStatus_1.Accelerating;
Decelerating_ReadStatus := MC_ReadStatus_1.Decelerating;

```

## Results

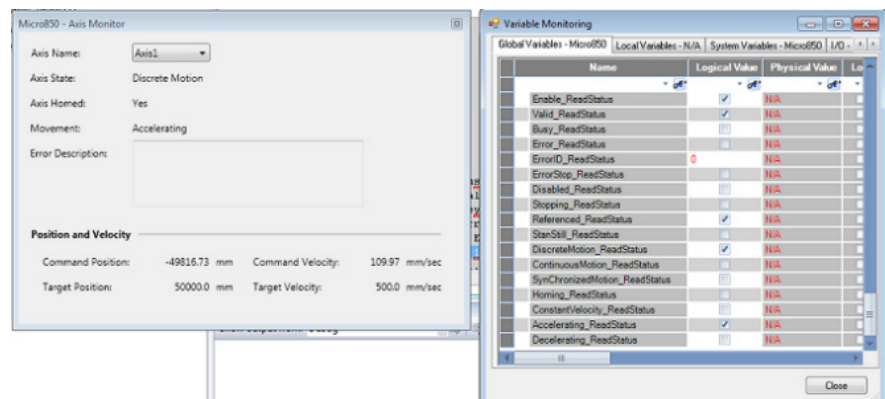

## MC\_Reset (motion control reset)

Transitions the axis state from ErrorStop to StandStill by resetting all internal axis-related errors. The outputs of the function block instances are not changed.

Operation details:

- If the axis alarm state is unchanged after executing MC\_Reset, execute MC\_Power followed by MC\_Reset.
- MC\_Reset only resets the axis state from ErrorStop to StandStill. Executing MC\_Reset when the axis is in other states, including Disabled, results in an error, and has no impact on on-going motion or the status of the axis.

Languages supported: Function Block Diagram, Ladder Diagram, Structured Text.

This instruction applies to the Micro830, Micro850 and Micro870 controllers that support motion control.

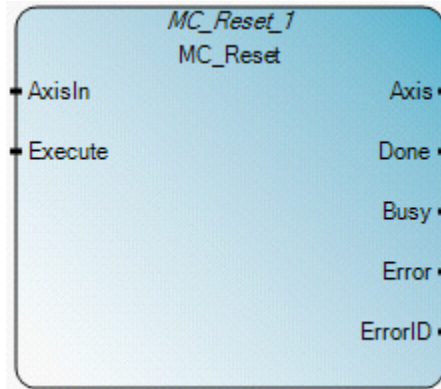

Use this table to help determine the parameter values for this instruction.

Parameter	Parameter type	Data type	Description
EN	Input	BOOL	Instruction block enable. TRUE, execute current MC_Reset computation. FALSE, there is no computation. Applies only to Ladder Diagram programs.
AxisIn	Input	AXIS_REF FB_AXIS_REF	Use the AXIS_REF data type to define AxisIn. For FB_Axis (feedback axis), use the <a href="#">FB_AXIS_REF data type</a> on <a href="#">page 414</a> to define AxisIn.
Execute	Input	BOOL	TRUE - resets the axis to the rising edge.
ENO	Output	BOOL	Enable output. Applies only to Ladder Diagram programs.
Axis	Output	AXIS_REF	Axis output is read-only in Ladder Diagram programs.
Done	Output	BOOL	TRUE - axis state is StandStill or Disabled.
Busy	Output	BOOL	TRUE - the function block is not finished.
Error	Output	BOOL	Indicates an error occurred. TRUE - An error is detected. FALSE - No error.
ErrorID	Output	UINT	A unique numeric that identifies the error. The errors for this instruction are defined in <a href="#">Motion control function block error IDs</a> on <a href="#">page 411</a> .

### MC\_Reset Function Block Diagram example

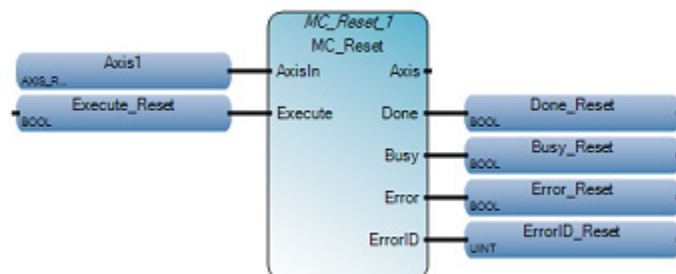

### MC\_Reset Ladder Diagram example

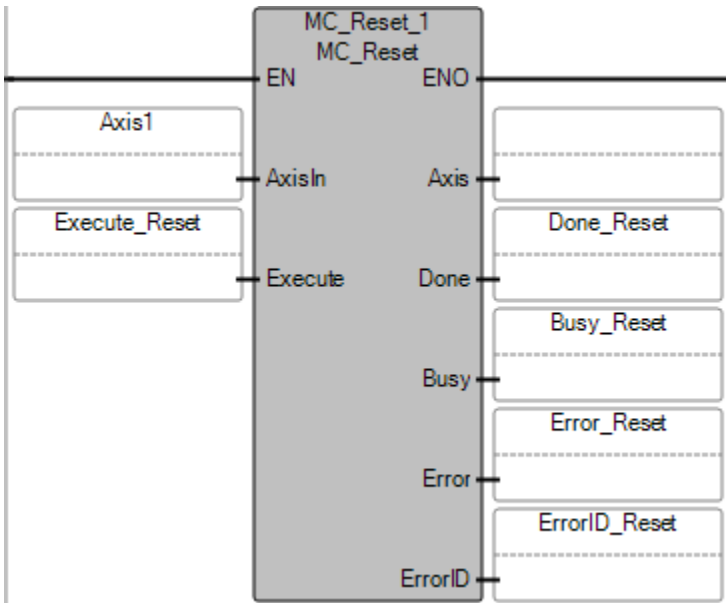

### MC\_Reset Structured Text example

```

MC_Reset_1(
void MC_Reset_1(AXIS_REF AxisIn, BOOL Execute)
Type : MC_Reset, Resets all internal axis-related errors

MC_Reset_1(Axis1, Execute_Reset);
Done_Reset := MC_Reset_1.Done;
Busy_Reset := MC_Reset_1.Busy;
Error_Reset := MC_Reset_1.Error;
ErrorID_Reset := MC_Reset_1.ErrorID;
    
```

### Results

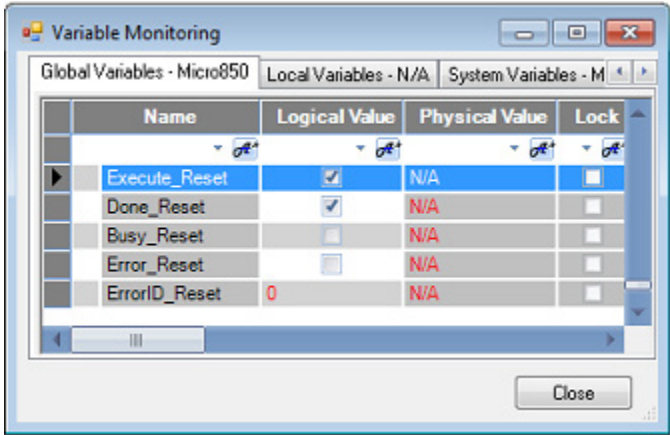

### MC\_SetPosition (motion control set position)

Shifts the coordinate system of an axis by manipulating the actual position of an axis with the same value without causing any movement.

Operation details:

- MC\_SetPosition can successfully complete only when the axis state is StandStill, continuous Motion (MC\_ExecutionMode = 0), or when the on-going motion completes, and ends with a StandStill state (MC\_ExecutionMode = 1).
- MC\_SetPosition operates the same as MC\_Home when the HomingMode = MC\_HOME\_DIRECT (0x04), except the MC\_Home function block sets the Axis Homed status.
- When MC\_ExecutionMode = 0 (mcImmediately), the execution of the MC\_SetPosition function block reports an error if there is on-going non-continuous motion with the axis.
- When MC\_ExecutionMode = 1 (mcQueued), the actual position setting occurs only when all previous on-going motion stops. That is, each previous function block must have at least one of the Done, Aborted, or Error outputs equal to True.

Languages supported: Function Block Diagram, Ladder Diagram, Structured Text.

This instruction applies to the Micro830, Micro850 and Micro870 controllers that support motion control.

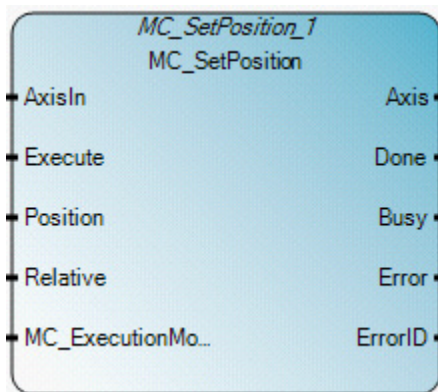

Use this table to help determine the parameter values for this instruction.

Parameter	Parameter type	Data type	Description
EN	Input	BOOL	Instruction block enable. TRUE - execute current MC_SetPosition computation. FALSE - there is no computation. Applies only to Ladder Diagram programs.
AxisIn	Input	AXIS_REF FB_AXIS_REF	Use the AXIS_REF data type to define AxisIn. For FB_Axis (feedback axis), use the <a href="#">FB_AXIS_REF data type</a> on <a href="#">page 414</a> to define AxisIn.
Execute	Input	BOOL	TRUE - starts setting the axis position.
Position	Input	REAL	The absolute position or relative distance to be set for the axis.
Relative	Input	BOOL	TRUE - set the relative distance for the axis. FALSE - set the absolute position for the axis.



Parameter	Parameter type	Data type	Description
MC_ExecutionMode	Input	SINT	<p>Values are:</p> <ul style="list-style-type: none"> <li>0 (<i>mcImmediately</i>) - The functionality is immediately valid.</li> <li>1 (<i>mcQueued</i>) - The new functionality becomes valid when:                             <ul style="list-style-type: none"> <li>all previous motion commands set to one of the following output parameters: Done, Aborted or Error.</li> <li>the axis is not in a moving state.</li> </ul> </li> </ul> <p>For (MC_ExecutionMode = 0), this function block successfully completes when the axis state is Disabled or StandStill. The execution of this function block reports an error if there is an on-going non-Continuous motion with the axis in this mode.</p> <p>For (MC_ExecutionMode = 1), this function block successfully completed when the axis state is Disabled, Standstill, or the on-going motion can complete, ending with a Standstill state.</p> <p>Other input values are reserved currently, and are considered as invalid parameters.</p>
ENO	Output	BOOL	<p>Enable output.</p> <p>Applies only to Ladder Diagram programs.</p>
Axis	Output	AXIS_REF	Axis output is read-only in Ladder Diagram programs.
Done	Output	BOOL	TRUE - the Position has new value.
Busy	Output	BOOL	TRUE - the function block is not finished.
Error	Output	BOOL	<p>Indicates an error occurred.</p> <p>TRUE - An error is detected.</p> <p>FALSE - No error.</p>
ErrorID	Output	UINT	A unique numeric that identifies the error. The errors for this instruction are defined in <a href="#">Motion control function block error IDs on page 411</a> .

### MC\_SetPosition Function Block Diagram example

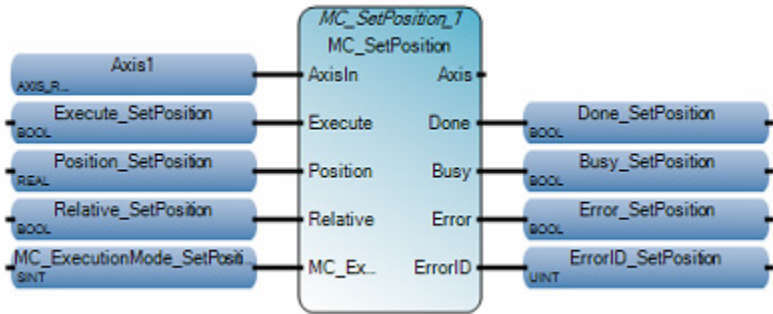

### MC\_SetPosition Ladder Diagram example

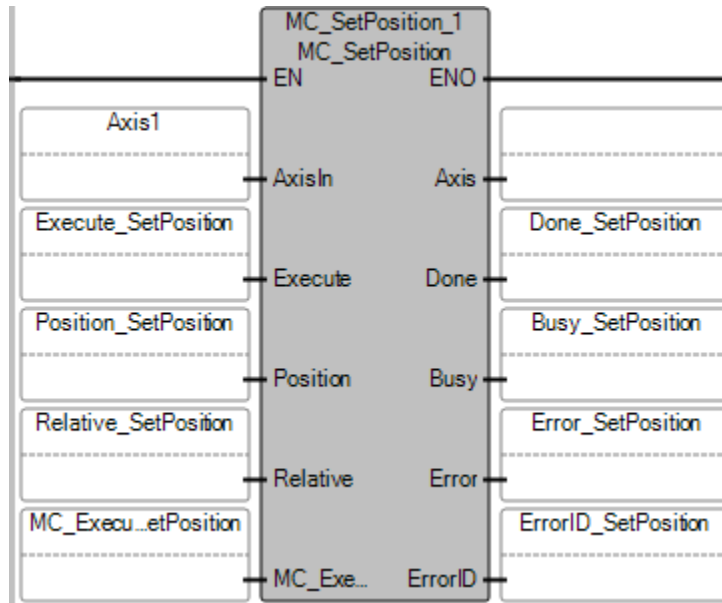

### MC\_SetPosition Structured Text example

```

MC_SetPosition_1
void MC_SetPosition_I (AXIS_REF AxisIn, BOOL Execute, REAL Position, BOOL Relative, SDINT MC_ExecutionMode)
Type : MC_SetPosition, Shifts the coordinate system of an axis by manipulating the actual position of the axis with the same value without any movement caused

Position_SetPosition := 10000.0;
Relative_SetPosition := TRUE;
MC_ExecutionMode_SetPosition := 0;
MC_SetPosition_1 (AxisIn, Execute_SetPosition, Position_SetPosition, Relative_SetPosition, MC_ExecutionMode_SetPosition);
Done_SetPosition := MC_SetPosition_1.Done;
Busy_SetPosition := MC_SetPosition_1.Busy;
Error_SetPosition := MC_SetPosition_1.Error;
ErrorID_SetPosition := MC_SetPosition_1.ErrorID;
    
```

### Results

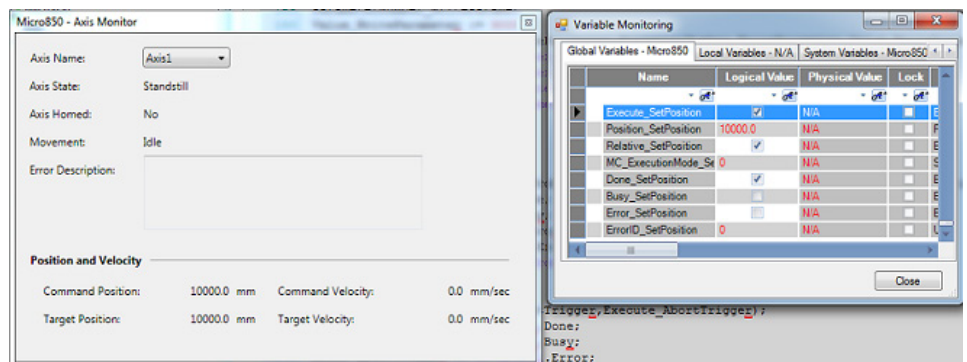

### MC\_Stop (motion control stop)

Commands a controlled motion stop and transfers the axis state to Stopping. Any ongoing function block execution is cancelled. All function block move commands are ignored until the axis state transitions to StandStill.

Operation details:

- As long as the Execute input is high, the axis remains in the Stopping state. While the axis is in the Stopping state, other motion function blocks cannot perform any motion on the same axis.
- If Deceleration equals zero, the MC\_Stop parameters are determined by the Axis configuration Emergency Stop setting, including E-Stop type, E-stop Deceleration and E-stop Jerk.
- When there are no errors detected during the stop sequence, the axis state transitions to StandStill after the Done bit is SET and the Execute input changes to False.
- Use MC\_Stop for emergency stop functionality or exception situations. Use MC\_Halt for normal motion stops.

Languages supported: Function Block Diagram, Ladder Diagram, Structured Text.

This instruction applies to the Micro830, Micro850 and Micro870 controllers that support motion control.

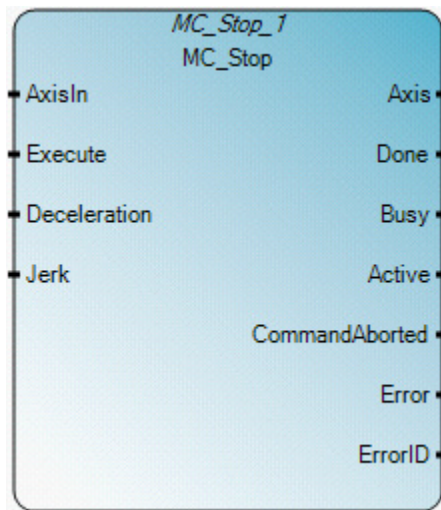

Use this table to help determine the parameter values for this instruction.

Parameter	Parameter type	Data type	Description
EN	Input	BOOL	Instruction block enable. TRUE - execute current MC_Stop computation. FALSE - there is no computation. Applies only to Ladder Diagram programs.
AxisIn	Input	AXIS_REF	Use the AXIS_REF data type to define the parameters for AxisIn.
Execute	Input	BOOL	TRUE - starts the action at the rising edge. FALSE - not executing.
Deceleration	Input	REAL	Value of the deceleration [u/s <sup>2</sup> ].
Jerk	Input	REAL	Value of the Jerk [u/s <sup>3</sup> ].
ENO	Output	BOOL	Enable output. Applies only to Ladder Diagram programs.
Axis	Output	<a href="#">AXIS_REF on page 413</a>	Axis output is read-only in Ladder Diagram programs.

Parameter	Parameter type	Data type	Description
Done	Output	BOOL	TRUE - zero velocity was reached, without error during the stop sequence.
Busy	Output	BOOL	TRUE - the function block is not finished.
Active	Output	BOOL	TRUE - indicates the function block has control on the axis.
CommandAborted	Output	BOOL	TRUE - command was overridden by MC_Power(OFF) function block, or ErrorStop.
Error	Output	BOOL	Indicates an error occurred. TRUE - An error is detected. FALSE - No error.
ErrorID	Output	UINT	A unique numeric that identifies the error. The errors for this instruction are defined in <a href="#">Motion control function block error IDs</a> on <a href="#">page 411</a> .

### MC\_Stop Function Block Diagram example

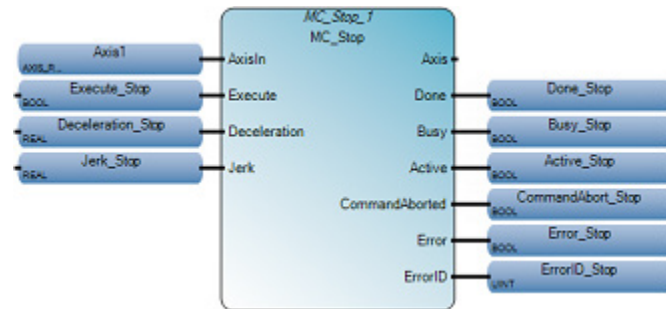

### MC\_Stop Ladder Diagram example

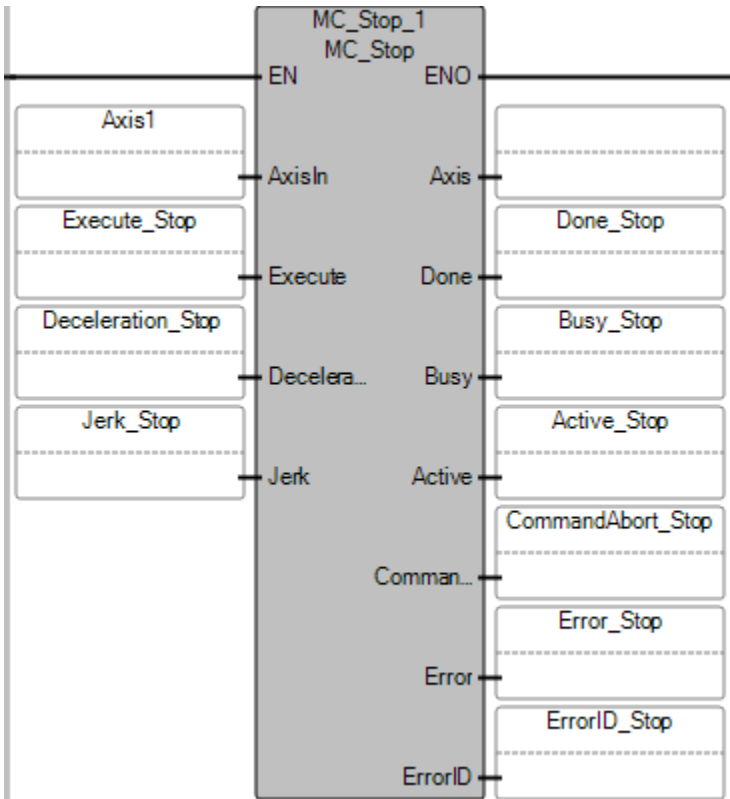

### MC\_Stop Structured Text example

```

MC_Stop_1(
void MC_Stop_1(AXIS_REF AxisIn, BOOL Execute, REAL Deceleration, REAL Jerk)
Type : MC_Stop, Commands a controlled motion stop and transfers the axis to the state Stopping.

Deceleration_Stop := 10.0;
Jerk_Stop := 10.0;
MC_Stop_1(Axis1,Execute_Stop,Deceleration_Stop,Jerk_Stop);
Done_Stop := MC_Stop_1.Done;
Busy_Stop := MC_Stop_1.Busy;
Active_Stop := MC_Stop_1.Active;
CommandAbort_Stop := MC_Stop_1.CommandAborted;
Error_Stop := MC_Stop_1.Error;
ErrorID_Stop := MC_Stop_1.ErrorID;
    
```

### Results

The **Micro850 - Axis Monitor** window shows the following data for Axis1:

- Axis Name: Axis1
- Axis State: Stopping
- Axis Homed: Yes
- Movement: Decelerating
- Position and Velocity:
  - Command Position: -39246.99 mm
  - Command Velocity: 333.53 mm/sec
  - Target Position: 0.0 mm
  - Target Velocity: 0.0 mm/sec

The **Variable Monitoring** window shows the following data for MC\_Stop\_1:

Name	Logical Value	Physical Value	Lock	Di
Execute_Stop	<input checked="" type="checkbox"/>	N/A	<input type="checkbox"/>	BOC
Deceleration_Stop	10.0	N/A	<input type="checkbox"/>	REA
Jerk_Stop	10.0	N/A	<input type="checkbox"/>	REA
Done_Stop	<input type="checkbox"/>	N/A	<input type="checkbox"/>	BOC
Busy_Stop	<input type="checkbox"/>	N/A	<input type="checkbox"/>	BOC
Active_Stop	<input checked="" type="checkbox"/>	N/A	<input type="checkbox"/>	BOC
CommandAbort_Sb	<input type="checkbox"/>	N/A	<input type="checkbox"/>	BOC
Error_Stop	<input type="checkbox"/>	N/A	<input type="checkbox"/>	BOC
ErrorID_Stop	0	N/A	<input type="checkbox"/>	UIN

## MC\_TouchProbe (motion control touch probe)

Records an axis position at a trigger event.

Operation details:

- If the window direction (first position --> last position) is in the opposite direction of the motion direction, the touch probe window does not activate.
- If the window setting (FirstPosition or LastPosition) is invalid, the MC\_TouchProbe function block reports an error.
- If a second instance of the MC\_TouchProbe function block is issued on the same axis, and the first function block instance is in a Busy state, the second function block instance reports an error.
- Only one MC\_TouchProbe function block instance should be issued to one axis.

Languages supported: Function Block Diagram, Ladder Diagram, Structured Text.

This instruction applies to the Micro830, Micro850 and Micro870 controllers that support motion control.

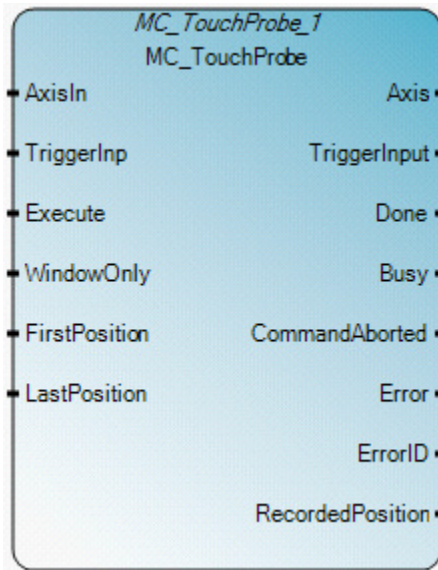

Use this table to help determine the parameter values for this instruction.

Parameter	Parameter type	Data type	Description
EN	Input	BOOL	Instruction block enable. TRUE - execute current MC_TouchProbe computation. FALSE - there is no computation. Applies only to Ladder Diagram programs.
AxisIn	Input	AXIS_REF FB_AXIS_REF	Use the AXIS_REF data type to define the parameters for AxisIn. For a feedback axis, use the <a href="#">FB_AXIS_REF data type</a> on <a href="#">page 414</a> to define the parameters for AxisIn.
TriggerInp	Input	USINT	Not supported currently. Configure input trigger in the Axis configuration.
Execute	Input	BOOL	TRUE - starts touch probe recording at the rising edge. FALSE - not executing.

Parameter	Parameter type	Data type	Description
WindowOnly	Input	BOOL	TRUE - only use the window to accept trigger events. Motion resolution is limited to the Motion Engine interval configured by the user. For WindowOnly TouchProbe functionality, there is a maximum response time delay that is equal to the Motion Engine interval for both FirstPosition and LastPosition activation. The maximum possible lag in the triggering position (both FirstPosition and LastPosition) can be calculated by (Motion Engine interval * moving velocity).
FirstPosition	Input	REAL	Start position of the window from where trigger events are accepted (in technical units [u]). Value included in window.
LastPosition	Input	REAL	Stop position of the window from where trigger events are not accepted (in technical units [u]). Value included in window.
ENO	Output	BOOL	Enable output. Applies only to Ladder Diagram programs.
Axis	Output	AXIS_REF FB_AXIS_REF	Axis output is read-only in Ladder Diagram programs.
TriggerInput	Output	USINT	Not supported currently.
Done	Output	BOOL	TRUE - trigger event was recorded.
Busy	Output	BOOL	TRUE - the function block is not finished.
CommandAborted	Output	BOOL	TRUE - the command was overridden by the MC_Power(OFF), or Error Stop function block.
Error	Output	BOOL	Indicates an error occurred. TRUE - An error is detected. FALSE - No error.
ErrorID	Output	UINT	A unique numeric that identifies the error. The errors for this instruction are defined in <a href="#">Motion control function block error IDs on page 411</a> .
RecordedPosition	Output	REAL	Position where trigger event occurred (in technical units [u]) Motion is an open-loop motion. The axis position at the time the trigger event occurs. If the axis motion is an open-loop motion, the commanded position (not an actual position) at the time the trigger event occurs, if there is no motion delay between the drive and the motor.

### Motion fixed input/output

Motion Signals	PT00	PT01	PT02
PTO pulse	Output_0	Output_1	Output2
PTO direction	Output_3	Output_4	Output_5
Lower (Negative) Limit switch	Input_0	Input_4	Input_8
Upper (Positive) Limit switch	Input_1	Input_5	Input_9
Absolute Home switch	Input_2	Input_6	Input_10
Touch Probe Input switch	Input_3	Input_7	Input_11

### MC\_TouchProbe Function Block Diagram example

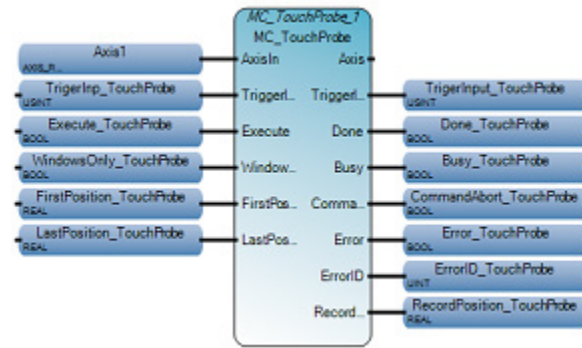

### MC\_TouchProbe Ladder Diagram example

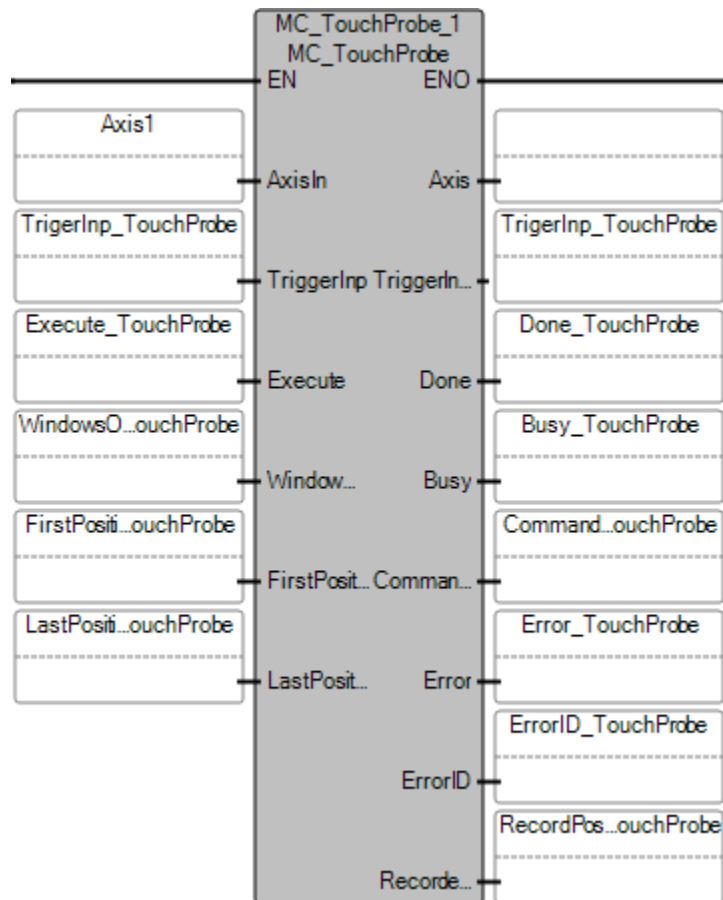

### MC\_TouchProbe Structured Text example

```

MC_TouchProbe_1 |
void MC_TouchProbe_1(AXIS_REF AxisIn, USINT TriggerInp, BOOL Execute, BOOL WindowOnly, REAL FirstPosition, REAL LastPosition)
Type : MC_TouchProbe, Records an axis position at a trigger event

FirstPosition_TouchProbe := 10000.0;
LastPosition_TouchProbe := 50000.0;
MC_TouchProbe_1(Axis1, TrigerInp_TouchProbe, Execute_TouchProbe, WindowsOnly_TouchProbe,
FirstPosition_TouchProbe, LastPosition_TouchProbe);
Done_TouchProbe := MC_TouchProbe_1.Done;
Busy_TouchProbe := MC_TouchProbe_1.Busy;
Error_TouchProbe := MC_TouchProbe_1.Error;
ErrorID_TouchProbe := MC_TouchProbe_1.ErrorID;
RecordPosition_TouchProbe := MC_TouchProbe_1.RecordedPosition;
    
```



## Results

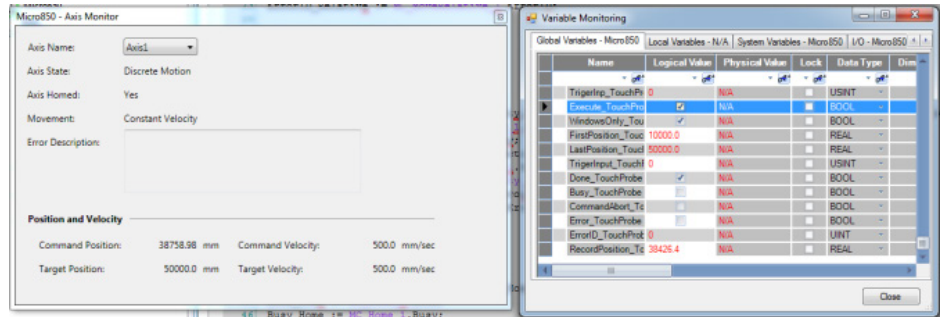

### MC\_WriteBoolParameter (motion control write BOOL parameter)

Modifies the value of a vendor specific parameter of type BOOL.

The parameters set by the MC\_WriteBoolParameter function block are only applied to the application temporarily. They are overwritten by the permanent settings, which are configured by the user in Connected Components Workbench Motion Configuration, when the controller is switched from PRG to RUN mode, or when the power to the controller is cycled OFF and ON.

Languages supported: Function Block Diagram, Ladder Diagram, Structured Text.

This instruction applies to the Micro830, Micro850 and Micro870 controllers that support motion control.

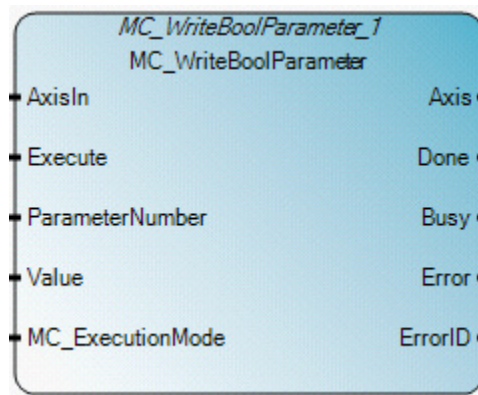

Use this table to help determine the parameter values for this instruction.

Parameter	Parameter type	Data type	Description
EN	Input	BOOL	Instruction block enable. TRUE - execute current MC_WriteBoolParameter computation. FALSE - the Value output is reset to 0. Applies only to Ladder Diagram programs.
AxisIn	Input	AXIS_REF FB_AXIS_REF	Use the AXIS_REF data type to define the parameters for AxisIn. For a feedback axis, use the FB_AXIS_REF data type to define the parameters for AxisIn.
Execute	Input	BOOL	TRUE - writes the value of the parameter at the rising edge.
ParameterNumber	Input	DINT	Parameter identification. The parameter number is defined in <a href="#">Motion control function block parameter details</a> on <a href="#">page 408</a> .

Parameter	Parameter type	Data type	Description
Value	Input	BOOL	TRUE - the specified parameter has a new value.
MC_ExecutionMode	Input	SINT	<p>Values are:</p> <ul style="list-style-type: none"> <li>• 0 (<i>mcImmediately</i>) - The functionality is immediately valid.</li> <li>• 1 (<i>mcQueued</i>) - The new functionality becomes valid when:                             <ul style="list-style-type: none"> <li>• all previous motion commands set one of the following output parameters: Done, Aborted or Error</li> <li>• the axis is not in a moving state.</li> </ul> </li> </ul> <p>When (MC_ExecutionMode = 0), for all parameters except Duty Cycle (1005), this FB can be completed successfully only when the axis state is Disabled or StandStill,</p> <p>When (MC_ExecutionMode = 0), for Parameter Duty Cycle (1005), this FB can be completed successfully except the axis is in Homing or ErrorStop state.</p> <p>For (MC_ExecutionMode = 1), this function block can be successfully completed only when the axis state is Disabled, Standstill, or the on-going motion can complete, ending with Standstill state</p> <p>Other input values are reserved currently, and are considered as invalid parameters.</p>
ENO	Output	BOOL	<p>Enable output.</p> <p>Applies only to Ladder Diagram programs.</p>
Axis	Output	AXIS_REF	Axis output is read-only in Ladder Diagram programs.
Done	Output	BOOL	TRUE - the parameter was successfully written.
Busy	Output	BOOL	TRUE - the function block is not finished.
Error	Output	BOOL	<p>Indicates an error occurred.</p> <p>TRUE - An error is detected.</p> <p>FALSE - No error.</p>
ErrorID	Output	UINT	A unique numeric that identifies the error. The errors for this instruction are defined in <a href="#">Motion control function block error IDs</a> on <a href="#">page 411</a> .

### MC\_WriteBoolParameter Function Block Diagram example

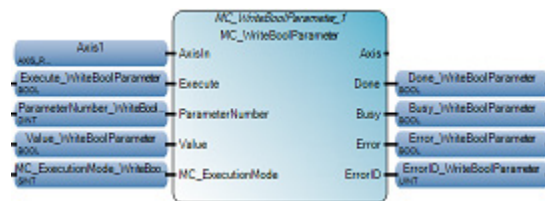

### MC\_WriteBoolParameter Ladder Diagram example

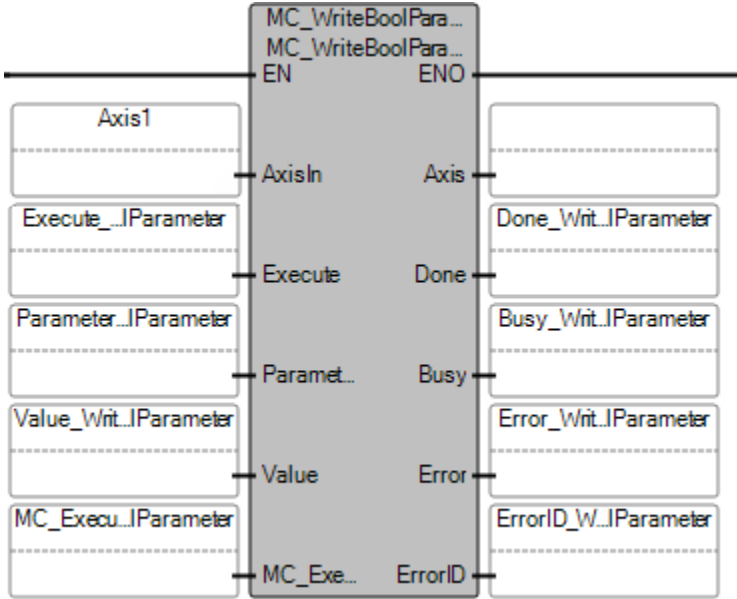

### MC\_WriteBoolParameter Structured Text example

```

MC_WriteBoolParameter_1
void MC_WriteBoolParameter_1(Axis_DEF Axis, BOOL Execute, SINT ParameterNumber, BOOL Value, SINT MC_ExecutionMode)
Type : MC_WriteBoolParameter, Modifies the value of a motion specific BOOL parameter

ParameterNumber_WriteBoolParameter := 5;
MC_WriteBoolParameter_1(Axis1, Execute_WriteBoolParameter, ParameterNumber_WriteBoolParameter,
Value_WriteBoolParameter, MC_ExecutionMode_WriteBoolParameter);
Done_WriteBoolParameter := MC_WriteBoolParameter_1.Done;
Busy_WriteBoolParameter := MC_WriteBoolParameter_1.Busy;
Error_WriteBoolParameter := MC_WriteBoolParameter_1.Error;
ErrorID_WriteBoolParameter := MC_WriteBoolParameter_1.ErrorID;
    
```

### Results

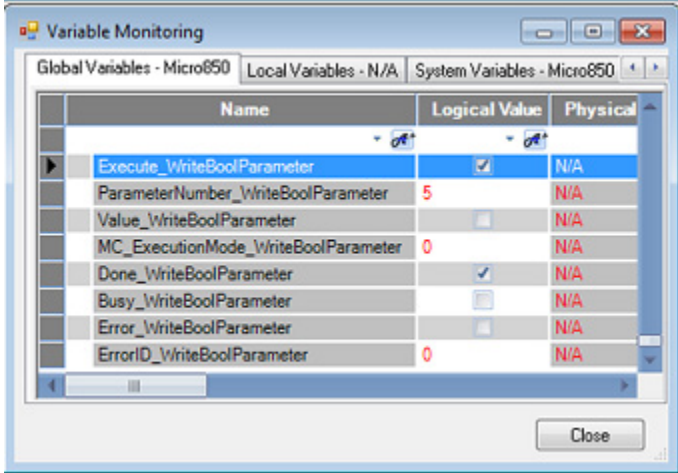

### MC\_WriteParameter (motion control write parameter)

Modifies the value of a vendor specific parameter of type REAL. The parameters set by the MC\_WriteParameter function block are only applied to the application temporarily. They are overwritten by the permanent settings, which are configured by the user in Connected Components Workbench Motion Configuration, when the controller is

switched from PRG to RUN, or when the controller power is cycled OFF and ON.

Languages supported: Function Block Diagram, Ladder Diagram, Structured Text.

This instruction applies to the Micro830, Micro850 and Micro870 controllers that support motion control.

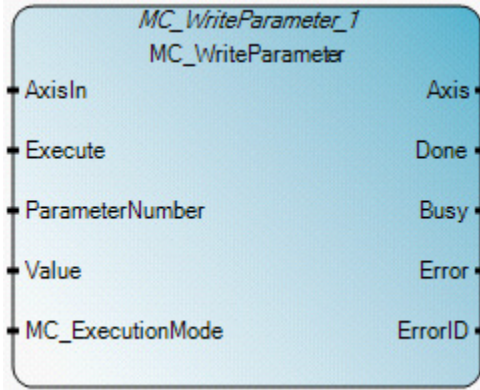

Use this table to help determine the parameter values for this instruction.

Parameter	Parameter type	Data type	Description
EN	Input	BOOL	Instruction block enable. TRUE - execute current MC_WriteParameter computation. FALSE - there is no computation. Applies only to Ladder Diagram programs.
AxisIn	Input	AXIS_REF FB_AXIS_REF	Use the <a href="#">AXIS_REF data type</a> on <a href="#">page 413</a> to define the parameters for AxisIn. For a feedback axis, use the <a href="#">FB_AXIS_REF data type</a> on <a href="#">page 414</a> to define the parameters for AxisIn.
Execute	Input	BOOL	TRUE - writes the value of the parameter at the rising edge.
ParameterNumber	Input	DINT	Parameter identification. The parameter number is defined in <a href="#">Motion control function block parameter details</a> on <a href="#">page 408</a> .
Value	Input	REAL	New value of the specified parameter.

Parameter	Parameter type	Data type	Description
MC_ExecutionMode	Input	SINT	<p>Values are:</p> <ul style="list-style-type: none"> <li>• 0 (<i>mcImmediately</i>) - The functionality is immediately valid.</li> <li>• 1 (<i>mcQueued</i>) - The new functionality becomes valid when:                             <ul style="list-style-type: none"> <li>• all previous motion commands set one of the following output parameters: Done, Aborted or Error</li> <li>• the axis is not in a moving state</li> <li>• implies that the output parameter Busy is set to FALSE.</li> </ul> </li> </ul> <p>When (MC_ExecutionMode = 0), for all parameters except Duty Cycle (1005), this FB can be completed successfully only when the axis state is Disabled or StandStill,</p> <p>When (MC_ExecutionMode = 0), for Parameter Duty Cycle (1005), this FB can be completed successfully except the axis is in Homing or ErrorStop state.</p> <p>For (MC_ExecutionMode = 1), this function block can be successfully completed only when the axis state is Disabled, Standstill, or the on-going motion can complete, ending with Standstill state.</p> <p>Other input values are reserved currently and are considered as invalid parameters.</p>
ENO	Output	BOOL	<p>Enable output.</p> <p>Applies only to Ladder Diagram programs.</p>
Axis	Output	AXIS_REF	Axis output is read-only in Ladder Diagram programs.
Done	Output	BOOL	TRUE - the parameter was successfully written.
Busy	Output	BOOL	TRUE - indicates the function block has control of the axis.
Error	Output	BOOL	<p>Indicates an error occurred.</p> <p>TRUE - An error is detected.</p> <p>FALSE - No error.</p>
ErrorID	Output	UINT	A unique numeric that identifies the error. The errors for this instruction are defined in <a href="#">Motion control function block error IDs on page 411</a> .

### MC\_WriteParameter Function Block Diagram example

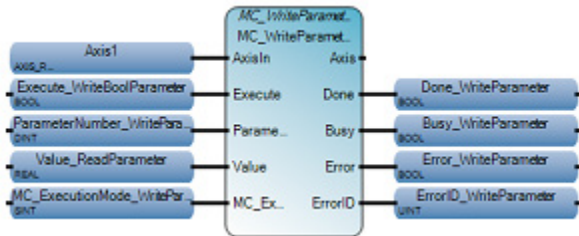

### MC\_WriteParameter Ladder Diagram example

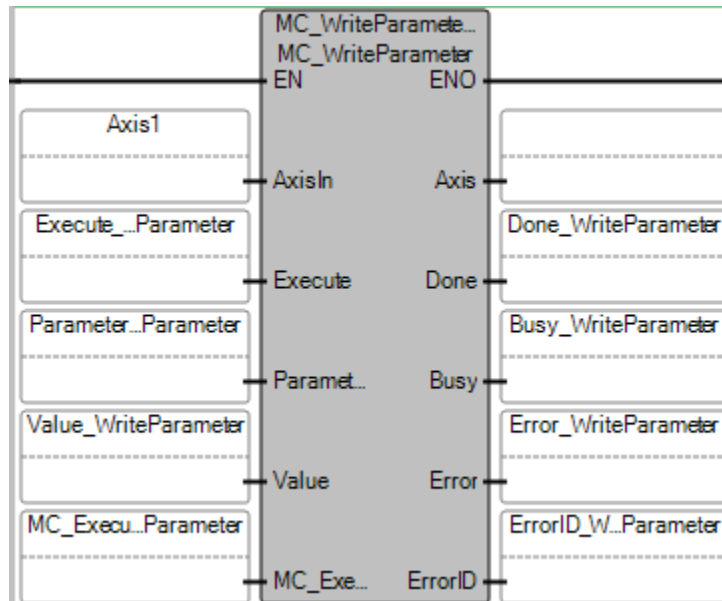

### MC\_WriteParameter Structured Text example

```

MC_WriteParameter_1(
void MC_WriteParameter_1(AXIS_REF AxisIn, BOOL Execute, DINT ParameterNumber, REAL Value, SINT MC_ExecutionMode)
Type : MC_WriteParameter, Modifies the value of a motion specific REAL parameter

ParameterNumber_WriteParameter := 2;
Value_WriteParameter := 90000.0;
MC_WriteParameter_1(Axis1, Execute_WriteParameter, ParameterNumber_WriteParameter,
Value_WriteParameter, MC_ExecutionMode_WriteParameter);
Done_WriteParameter := MC_WriteParameter_1.Done;
Busy_WriteParameter := MC_WriteParameter_1.Busy;
Error_WriteParameter := MC_WriteParameter_1.Error;
ErrorID_WriteParameter := MC_WriteParameter_1.ErrorID;

```

### Results

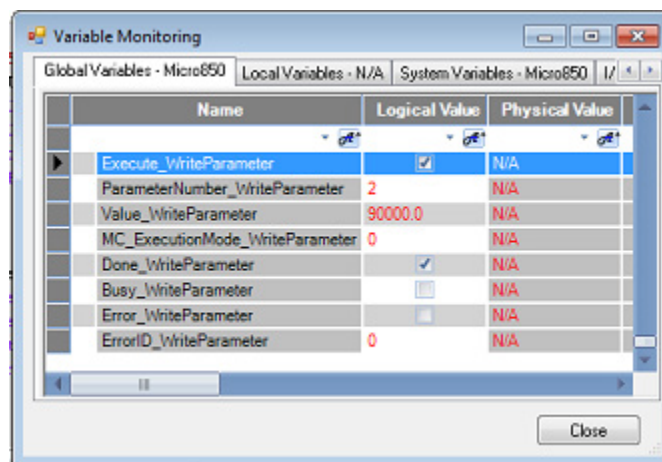

## Process control instructions

Use Process control instructions to monitor and maintain process loops for quantities such as pressure, temperature, flow rate, and fluid level. Process controls regulate the course by sending an output signal to the control valve.

Instruction	Description
<a href="#">DERIVATE</a> on <a href="#">page 479</a>	Differentiates a real value over a defined cycle time.
<a href="#">FFL</a> on <a href="#">page 481</a>	Loads 8 bit, 16 bit, 32 bit, or 64 bit data into a user-created array called a FIFO stack.
<a href="#">FFU</a> on <a href="#">page 489</a>	Unloads 8 bit, 16 bit, 32 bit, or 64 bit data from a user-created array called a FIFO stack. The data unloads in the same order as loaded using the FFL instruction.
<a href="#">HYSTER</a> on <a href="#">page 494</a>	Performs a Boolean hysteresis on difference of reals.
<a href="#">INTEGRAL</a> on <a href="#">page 496</a>	Integrates a real value during the defined cycle time.
<a href="#">LFL (LIFO load)</a> on <a href="#">page 501</a>	Loads 8 bit, 16 bit, 32 bit, or 64 bit data into a user-created array called a LIFO stack.
<a href="#">LFU (LIFO unload)</a> on <a href="#">page 503</a>	Unloads 8 bit, 16 bit, 32 bit, or 64 bit data from a user-created array called a LIFO stack. The data unloads in the same order as loaded using the LFL instruction.
<a href="#">PWM</a> on <a href="#">page 505</a>	Turns the pulse width modulation (PWM) output for a configured PWM channel ON or OFF.
<a href="#">SCALER</a> on <a href="#">page 508</a>	Scales the input value according to the output range.
<a href="#">STACKINT</a> on <a href="#">page 510</a>	Manages a stack of integer values.
<a href="#">LIMIT</a> on <a href="#">page 521</a>	Restricts integer values to a given interval.
<a href="#">TND</a> on <a href="#">page 520</a>	Stops the current cycle of the user program scan.

### DERIVATE

Differentiation of a real value over a defined cycle time.

Operation details:

- If the **CYCLE** parameter value is less than the cycle timing of the execution of the device, the sampling period is forced to this cycle timing.
- The derivation is performed with a time base of milliseconds. For example, the derivation of an input of 1000 that changes to 2000 over a time period of 1 second results in a value of 1. To convert the output of the instruction to units of seconds, multiply the output by 1000.

Languages supported: Function Block Diagram, Ladder Diagram, Structured Text.

This instruction applies to the Micro810, Micro820, Micro830, Micro850, Micro870 controllers and Micro800 Simulator.



Use this table to help determine the parameter values for this instruction.

Parameter	Parameter type	Data type	Description
RUN	Input	BOOL	Indicates the operational mode of the instruction. TRUE - normal (perform calculation) FALSE - reset
XIN	Input	REAL	Defines the value on which to perform the derivation calculation. The value must be a REAL value.
CYCLE	Input	TIME	Defines the sampling time period over which to collect values. Possible time period values range from 0ms to 49d17h2m47s294ms.
XOUT	Output	REAL	Differentiated output.
ENO	Output	BOOL	Enable output. Applies only to Ladder Diagram programs.

### DERIVATE Function Block Diagram example

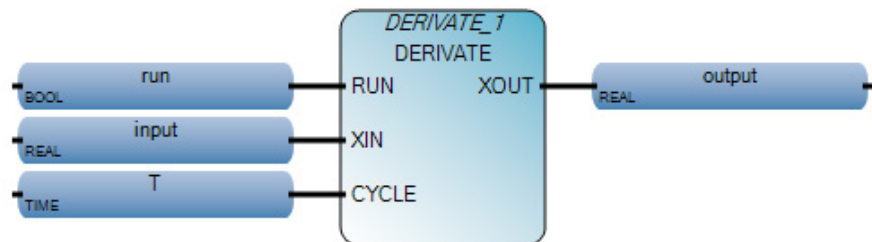

### DERIVATE Ladder Diagram example

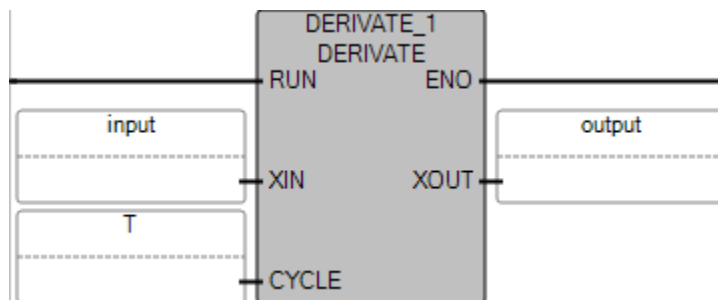



## DERIVATE Structured Text example

```
DERIVATE_1(
void DERIVATE_1(BOOL RUN, REAL XIN, TIME CYCLE)
Type : DERIVATE, Differentiation according to time
```

```
1 DERIVATE_1(run, input, T);
2 output := DERIVATE_1.XOUT;
```

(\* ST Equivalence: DERIVATE1 is an instance of a DERIVATE block \*)

```
DERIVATE1(manual_mode, sensor_value, t#100ms);
derivated_value := DERIVATE1.XOUT;
```

## FFL (FIFO load)

Loads 8 bit, 16 bit, 32 bit, or 64 bit data into a user-created array called a FIFO stack.

Operation details:

- FFL instruction - non executing mode to executing mode
  - When Execute changes from FALSE to TRUE:
    - Error conditions are verified.
    - The contents of Src are loaded into the FIFO stack in the available position and Position increments by 1 if Position is less than or equal to zero and less than Length.
    - Full is set to TRUE if Length equals Position. Full is FALSE if Position is less than or equal to zero and less than Length.
    - Done is set when the instruction executes successfully.
  - When Execute changes from TRUE to FALSE:
    - Error, Done, and ErrorID are set to FALSE.
    - Empty is set to TRUE if Position is equal to zero.
    - Full is set to TRUE when Length equals Position. Full is FALSE if Position is less than or equal to zero and less than Length.
    - The FFL error conditions are not verified.
  - When Execute changes from TRUE to TRUE:
    - No load operation is performed.
    - Empty is set to TRUE if Position is equal to zero.
    - Full is set to FALSE if Position is less than or equal to zero and less than Length. Full is set to TRUE if Length equals Position.
    - The FFL error conditions are not verified.
  - When Execute changes from FALSE to FALSE:
    - Error, Done, and ErrorID bits are set to FALSE.
    - Full and Empty bits retain values from previous execution state.
  - Empty is set to TRUE if Position is equal to zero.
    - Full is set to TRUE if Length equals Position. Full is FALSE if Position is less than or equal to zero and less than Length.
    - FLL error conditions are not verified.

- FFL instruction - executing mode to non-executing mode:
  - Error, ErrorID, Done, Empty, and Full retain the Execute mode state.
- To create a single element for the FIFO parameter:
  - Non array:
    - Variable based address such as Fifo1 is allowed for FIFO.
    - Length should be configured as 1.
  - Array:
    - Variable based address such as Fifo1 or Fifo1[0] is allowed for FIFO.
    - Length should be configured as 1.

Languages supported: Function Block Diagram, Ladder Diagram, Structured Text.

This instruction applies to the Micro820, Micro830, Micro850, Micro870 controllers and Micro800 Simulator.

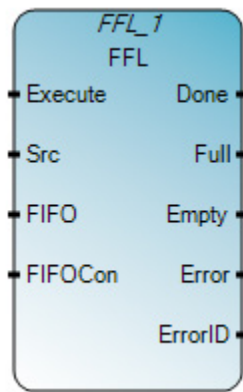

Use this table to help determine the parameter values for this instruction.

Parameter	Parameter Type	Data Type	Description
Execute	Input	BOOL	Instruction block enable. TRUE - If rising edge is detected, start the FFL operation. FALSE - Rising edge is not detected.
Src	Input	ANY_ELEMENTARY	The Src operand is the address of the value used to fill the currently available position in the FIFO stack. Elementary data types supported for Src: <ul style="list-style-type: none"> <li>• DWORD, REAL, TIME, DATE, LWORD, ULINT, LINT, LREAL, BOOL, SINT, USINT, BYTE, INT, UINT, WORD, DINT, UDINT.</li> <li>• Sting is not supported.</li> <li>• Array elements such as Array[1] or Array[Index] are supported.</li> </ul>

FIFO	Input	ANY_ELEMENTARY	The starting address of the stack. FIFO must be configured the same for the FFL and FFU instructions. Elementary data types supported for FIFO: DWORD, REAL, TIME, DATE, LWORD, ULINT, LINT, LREAL, BOOL, SINT, USINT, BYTE, INT, UINT, WORD, DINT, UDINT. <ul style="list-style-type: none"> <li>String is not supported.</li> <li>Only single dimension array is supported for FIFO.</li> </ul>
FIFOCon	Input	FF_LF_CON	FIFO configuration and control. The same configuration must be configured for FFL and FFU instructions. Use the FF_LF_CON data type to configure Position and Length.
Done	Output	BOOL	Indicates when the FFU operation is complete. TRUE - Operation completed successfully. FALSE - Operation encountered an error condition or the FFU instruction is not executing.
Empty	Output	BOOL	Indicates when the FIFO stack is empty. TRUE - When Position equals 0. FALSE - When Position is not equal to 0.
Full	Output	BOOL	Indicates when the FIFO stack is full. TRUE - When Length is equal to Position. FALSE - When Position is greater than or equal to zero and less than Length.
Error	Output	BOOL	Indicates the existence of an error condition. TRUE - Operation encountered an error. FALSE - Operation completed successfully or the instruction is not executing.
ErrorID	Output	USINT	A unique numeric that identifies the error. The errors are defined in FFL error codes.

### FF\_LF\_CON data type

Use this table to help determine the parameter values for the FF\_LF\_CON data type.

Parameter	Data type	Description
Length	UINT	Number of elements used for FIFO operation. Maximum limit is 1024.
Position	USINT	Determines the next available location in the FIFO for the Src entry or removal. Position is the offset of the array. Example 1: <ul style="list-style-type: none"> <li>User configured array, arr[0..5]. Initial position is configured as 1. Data is pushed into arr[1] and position increments by position + 1.</li> </ul> Example 2: <ul style="list-style-type: none"> <li>User configured array as arr[1..5]. Initial position is configured as 1. Data is pushed into arr[2] and position increments by position + 1.</li> </ul>

### FFL error codes

Use this table to determine the FFL and FFU error codes and descriptions.

Error code	Error description
0	No error.
1	FFL Src data type is not supported.
2	FFU Dest data type is not supported.
3	FIFO data type is not supported.

4	Src and Dest data type mismatch with the FIFO data type. Corrective Action: FFL Src parameter and FFU Dest parameter data type should match with the FIFO array data type.
5	FIFO - Array dimension is not supported. Corrective Action: FIFO only supports single dimension Arrays.
6	FIFOCon control Length exceeds FIFO array size. Corrective Action: FIFOCon control Length cannot exceed the FIFO array size.
7	FIFOCon Length exceeds the max length.
8	FIFOCon Length is zero.
9	FIFOCon Position exceeds the FIFOCon Length.
10	FFL control Length and Position are equal.
11	FFU control Position is zero.
12	FFL or FFU array dimension is not supported. Corrective Acton: FFL and FFU only support single dimension arrays.
13	FFL or FFU DestOffset exceeds Dest array size.

### FFL Function Block Diagram example

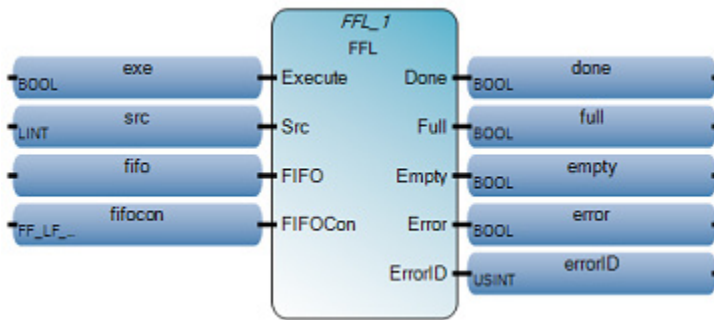

### FFL Ladder Diagram example

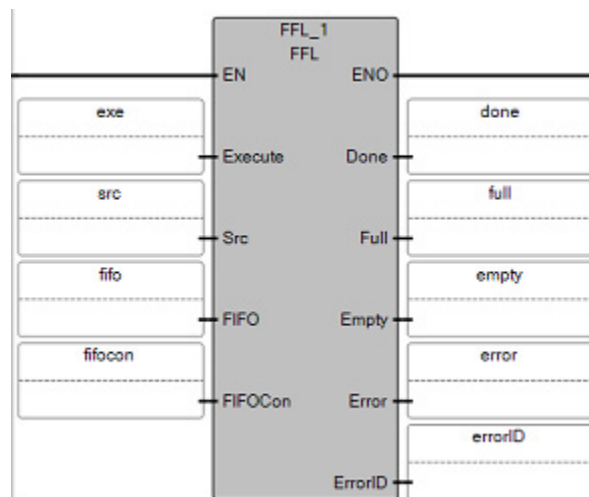

### FFL Structured Text example

```

1 FFL_1(exe, src, fifo, fifocon);
2 done := FFL_1.Done;
3 full := FFL_1.Full;
4 empty := FFL_1.Empty;
5 error := FFL_1.Error;
6 errorID := FFL_1.ErrorID;

```

```

FFL_1
void FFL_1(BOOL Execute, ANY_ELEMENTARY Src, ANY_ELEMENTARY[1..1] FIFO, FF_LF_CON FIFOcon)
Type: FFL, FIFO Load

```

### Results

Name	Logical Value	Physical Value	Initial Value	Lock	Data Type	Dimension
src	<input type="checkbox"/>	NO		<input type="checkbox"/>	BOOL	
full	<input type="checkbox"/>	NO		<input type="checkbox"/>	BOOL	
fifocon	...	...	...	<input type="checkbox"/>	FF_LF_CON	
fifocon.Length	10	NO		<input type="checkbox"/>	UINT	
fifocon.Position	1	NO		<input type="checkbox"/>	UINT	
fifo	...	...	...	<input type="checkbox"/>	BOOL	[1..10]
fifo[1]	<input checked="" type="checkbox"/>	NO		<input type="checkbox"/>	BOOL	
fifo[2]	<input type="checkbox"/>	NO		<input type="checkbox"/>	BOOL	
fifo[3]	<input type="checkbox"/>	NO		<input type="checkbox"/>	BOOL	
fifo[4]	<input type="checkbox"/>	NO		<input type="checkbox"/>	BOOL	
fifo[5]	<input type="checkbox"/>	NO		<input type="checkbox"/>	BOOL	
fifo[6]	<input type="checkbox"/>	NO		<input type="checkbox"/>	BOOL	
fifo[7]	<input type="checkbox"/>	NO		<input type="checkbox"/>	BOOL	
fifo[8]	<input type="checkbox"/>	NO		<input type="checkbox"/>	BOOL	
fifo[9]	<input type="checkbox"/>	NO		<input type="checkbox"/>	BOOL	
fifo[10]	<input type="checkbox"/>	NO		<input type="checkbox"/>	BOOL	
FFL_1	...	...	...	<input type="checkbox"/>	FFL	
exe	<input type="checkbox"/>	NO		<input type="checkbox"/>	BOOL	
errorID	0	NO		<input type="checkbox"/>	USINT	
error	<input type="checkbox"/>	NO		<input type="checkbox"/>	BOOL	
empty	<input type="checkbox"/>	NO		<input type="checkbox"/>	BOOL	
done	<input type="checkbox"/>	NO		<input type="checkbox"/>	BOOL	

### FFL and FFU instruction timing diagrams

The following timing diagram examples describe execution scenarios for the [FFL](#) on [page 481](#) (FIFO load) and [FFU](#) on [page 489](#) (FIFO unload) instructions.

### Successful FFL execution followed by successful FFU execution

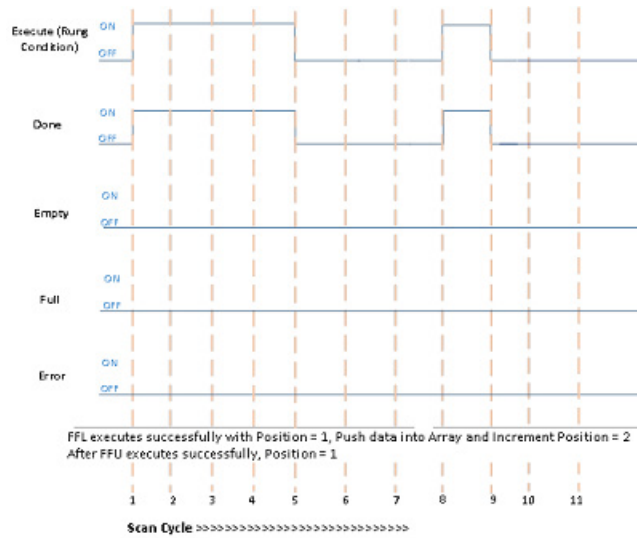

Use this table to help determine the parameter values for each scan cycle.

Scan Cycle	Description
1	Rung condition becomes TRUE when: <ul style="list-style-type: none"> <li>Execute input bit is TRUE.</li> <li>Load (push) data to FIFO stack.</li> <li>Done output bit is TRUE.</li> </ul>
2,3,4	No change in rung condition.
5	Rung condition becomes FALSE when: <ul style="list-style-type: none"> <li>Execute bit is FALSE.</li> <li>Done output bit is FALSE.</li> </ul>
6, 7	No change in rung condition. <ul style="list-style-type: none"> <li>Execute bit is FALSE.</li> <li>Done output bit is FALSE.</li> </ul>
8	Rung goes TRUE when: <ul style="list-style-type: none"> <li>Execute input bit is TRUE.</li> <li>Unload data from FIFO stack.</li> <li>Done output bit is TRUE.</li> </ul>
9	No change in rung condition. <ul style="list-style-type: none"> <li>Execute bit is FALSE.</li> <li>Done output bit is FALSE.</li> </ul>
10, 11	No change in rung condition.

### Successful execution when the Empty bit is TRUE

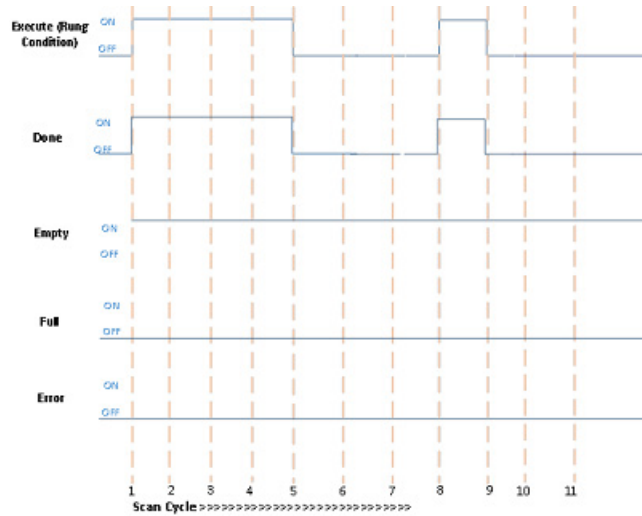

Use this table to help determine the parameter values for each scan cycle.

Scan Cycle	Description
1	Rung condition becomes TRUE when: <ul style="list-style-type: none"> <li>Execute input bit is TRUE. Execution starts.</li> <li>Position is zero. Empty bit is TRUE.</li> <li>Done output bit is TRUE.</li> </ul>
2,3,4	No change in rung condition.
5	Rung condition becomes FALSE when: <ul style="list-style-type: none"> <li>Execute bit is FALSE.</li> <li>Empty bit is TRUE.</li> <li>Done output bit is FALSE.</li> </ul>
6, 7	No change in rung condition.
8	Rung goes TRUE when: <ul style="list-style-type: none"> <li>Execute input bit is TRUE. Execution starts.</li> <li>Empty bit is TRUE.</li> <li>Done output bit is TRUE.</li> </ul>
9	Rung condition becomes FALSE when: <ul style="list-style-type: none"> <li>Execute bit is FALSE.</li> <li>Empty bit is TRUE.</li> <li>Done output bit is FALSE.</li> </ul>
10, 11	No change in rung condition.

### Successful execution when the Empty bit is TRUE

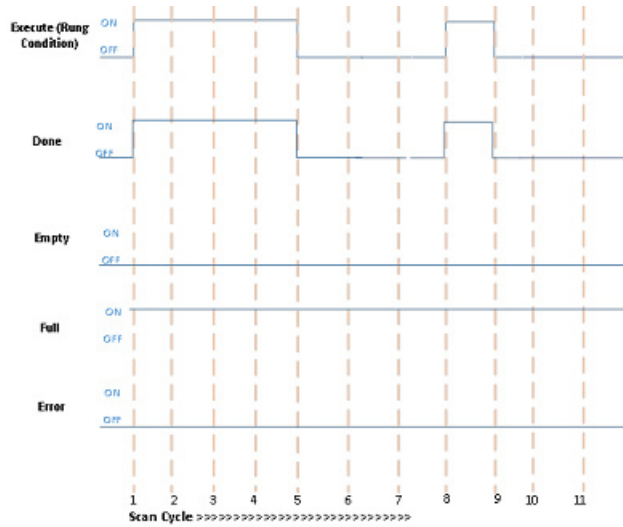

Use this table to help determine the parameter values for each scan cycle.

Scan Cycle	Description
1	Rung condition becomes TRUE when: <ul style="list-style-type: none"> <li>Execute input bit is TRUE. Execution starts.</li> <li>Position is equal to Length, Full bit is TRUE.</li> <li>Done output bit is TRUE.</li> </ul>
2,3,4	No change in rung condition.
5	Rung condition becomes FALSE when: <ul style="list-style-type: none"> <li>Execute bit is FALSE.</li> <li>Full bit is TRUE.</li> <li>Done output bit is FALSE.</li> </ul>
6, 7	No change in rung condition.
8	Rung goes TRUE when: <ul style="list-style-type: none"> <li>Execute input bit is TRUE. Execution starts.</li> <li>Full bit is TRUE.</li> <li>Done output bit is TRUE.</li> </ul>
9	Rung condition becomes FALSE when: <ul style="list-style-type: none"> <li>Execute bit is FALSE.</li> <li>Full bit is TRUE.</li> <li>Done output bit is FALSE.</li> </ul>
10, 11	No change in rung condition.



## Error encountered during FFL and FFU execution

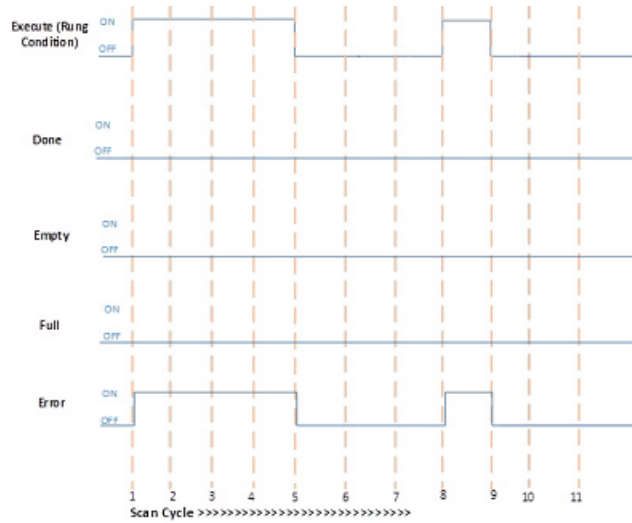

Use this table to help determine the parameter values for each scan cycle.

Scan Cycle	Description
	Rung condition becomes TRUE when: <ul style="list-style-type: none"> <li>Execute input bit is TRUE. Execution starts.</li> <li>Error bit is TRUE.</li> </ul>
2,3,4	No change in rung condition.
5	Rung condition becomes FALSE when: <ul style="list-style-type: none"> <li>Execute bit is FALSE.</li> <li>Error and ErrorID bits are FALSE.</li> </ul>
6, 7	No change in rung condition.
8	Rung goes TRUE when: <ul style="list-style-type: none"> <li>Execute input bit is TRUE. Execution starts.</li> <li>Error bit is TRUE.</li> </ul>
9	Rung condition becomes FALSE when: <ul style="list-style-type: none"> <li>Execute bit is FALSE.</li> <li>Error and ErrorID bits are FALSE.</li> </ul>
10, 11	No change in rung condition.

### FFU (FIFO unload)

Unloads 8 bit, 16 bit, 32 bit, or 64 bit data from a user-created array called a FIFO (first in first out) stack in the same order data was loaded using the FFL instruction.

Operation details:

- FFU instruction - non executing mode to executing mode:
  - When Execute changes from FALSE to TRUE:
    - FFU error conditions are verified.
    - Unloads the contents of the FIFO stack at the zero position if Position is greater than zero and less than or equal to Length.

- Remaining elements shift one position towards zero and the highest element of the FIFO stack is set with zero, Position is decremented by 1.
- Empty is set to TRUE if Position equals zero.
- Done is set when the instruction executes successfully.
- When Execute changes from TRUE to FALSE:
  - Error, Done, and ErrorID are set to FALSE.
  - Empty is set to TRUE if Position is equal to zero.
  - Full is set to TRUE if Length equals Position. Full is set to FALSE if Position is less than or equal to zero and less than Length.
  - The FFU error conditions are not verified.
- When Execute changes from TRUE to TRUE:
  - No unload operation performed.
  - Empty is set to TRUE if Position is equal to zero.
  - Full is set to TRUE if Length equals Position.
  - The FFU error conditions are not verified.
- When Execute changes from FALSE to FALSE:
  - Error, Done, and ErrorID are set to FALSE.
  - Empty is set to TRUE if Position is equal to zero.
  - Full is set to TRUE if Length equals Position. Full is set to FALSE if Position is less than or equal to zero and less than Length.
  - The FLU error conditions are not verified.
- FFU instruction - executing mode to non-executing mode:
  - Error, ErrorID, Done, Empty, and Full retain the Execute mode state.
- To create a single element for the FIFO parameter:
  - Non array:
    - Variable based address such as Fifo1 is allowed for FIFO.
    - Length should be configured as 1.
  - Array:
    - Variable based address such as Fifo1 or Fifo1[0] is allowed for FIFO.
    - Length should be configured as 1.

Languages supported: Function Block Diagram, Ladder Diagram, Structured Text.

This instruction applies to the Micro820, Micro830, Micro850, Micro870 controllers and Micro800 Simulator.

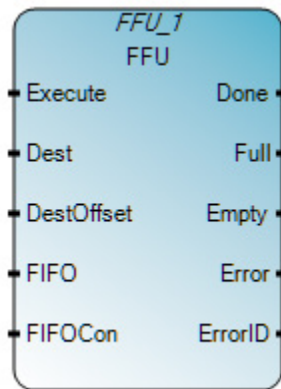

Use this table to help determine the parameter values for this instruction.

Parameter	Parameter Type	Data Type	Description
Execute	Input	BOOL	Instruction block enable. TRUE - If rising edge is detected, start FFU operation. FALSE - Rising edge is not detected.
Dest	Input	ANY_ELEMENTARY	Holds the value that exists in the FIFO stack. Elementary data types supported for Dest: <ul style="list-style-type: none"> <li>• DWORD, REAL, TIME, DATE, LWORD, ULINT, LINT, LREAL, BOOL, SINT, USINT, BYTE, INT, UINT, WORD, DINT, UDINT.</li> <li>• Sting is not supported.</li> <li>• Only supports single dimension arrays such as Array[1] or Array[Index].</li> </ul>
DestOffset	Input	UINT	Destination element offset. Element offset if destination is array data type, otherwise offset should be set to 0. For array data type, to unload to the first element, the offset should be set as 0.
FIFO	Input	ANY_ELEMENTARY	The starting address of the stack. FIFO must be configured the same in the FFL and FFU instructions. <ul style="list-style-type: none"> <li>• Elementary data types supported for FIFO: DWORD, REAL, TIME, DATE, LWORD, ULINT, LINT, LREAL, BOOL, SINT, USINT, BYTE, INT, UINT, WORD, DINT, UDINT.</li> <li>• String is not supported.</li> <li>• Only single dimension is supported for FIFO.</li> </ul>
FIFOCon	Input	FF_LF_CON	FIFO configuration and control. The same configuration must be configured for FFL and FFU instructions. Use the FF_LF_CON data type to configure Position and Length.
Done	Output	BOOL	Indicates when the FFU operation is complete. TRUE - Operation completed successfully. FALSE - Operation encountered an error condition or the FFU instruction is not executing.
Full	Output	BOOL	Indicates when the FIFO stack is full. TRUE - When Length is equal to Position. FALSE - When Position is greater than zero and less than Length.
Empty	Output	BOOL	Indicates when the FIFO stack is empty. TRUE - When Position equals 0. FALSE - When Position is not equal to 0.

Error	Output	BOOL	Indicates the existence of an error condition. TRUE - Operation encountered an Error. FALSE - Operation completed successfully or the instruction is not executing.
ErrorID	Output	USINT	A unique numeric that identifies the error. The errors are defined in FFU error codes.

## FF\_LF\_CON Data Type

Use this table to help determine the parameter values for the FF\_LF\_CON data type.

Parameter	Data type	Description
Length	UINT	Number of elements used for FIFO operation. Maximum limit is 1024.
Position	USINT	Determines the next available location in the FIFO for the Src entry or removal. Position is the offset of the array. Example 1: <ul style="list-style-type: none"> <li>User configured array, arr[0..5]. Initial position is configured as 1. Data is pushed into arr[1] and position increments by position + 1.</li> </ul> Example 2: <ul style="list-style-type: none"> <li>User configured array as arr[1..5]. Initial position is configured as 1. Data is pushed into arr[2] and position increments by position + 1.</li> </ul>

## FFU error codes

Use this table to determine the FFL and FFU error codes and descriptions.

Error code	Error description
0	No error.
1	FFL Src data type is not supported.
2	FFU Dest data type is not supported.
3	FIFO data type is not supported.
4	Src and Dest data type mismatch with the FIFO data type. Corrective Action: FFL Src parameter and FFU Dest parameter data type should match with the FIFO array data type.
5	FIFO - Array dimension is not supported. Corrective Action: FIFO only supports single dimension Arrays.
6	FIFOCon control Length exceeds FIFO array size. Corrective Action: FIFOCon control Length cannot exceed the FIFO array size.
7	FIFOCon Length exceeds the max length.
8	FIFOCon Length is zero.
9	FIFOCon Position exceeds the FIFOCon Length.
10	FFL control Length and Position are equal.
11	FFU control Position is zero.
12	FFL or FFU array dimension is not supported. Corrective Acton: FFL and FFU only support single dimension arrays.
13	FFL or FFU DestOffset exceeds Dest array size.

### FFU Function Block Diagram example

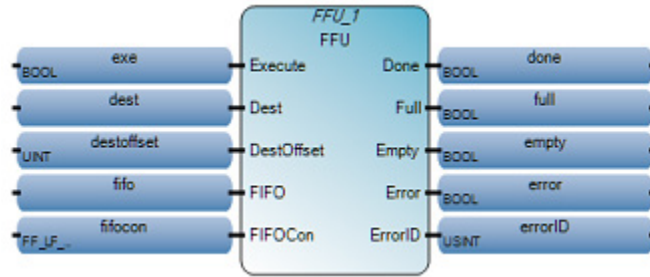

### FFU Ladder Diagram example

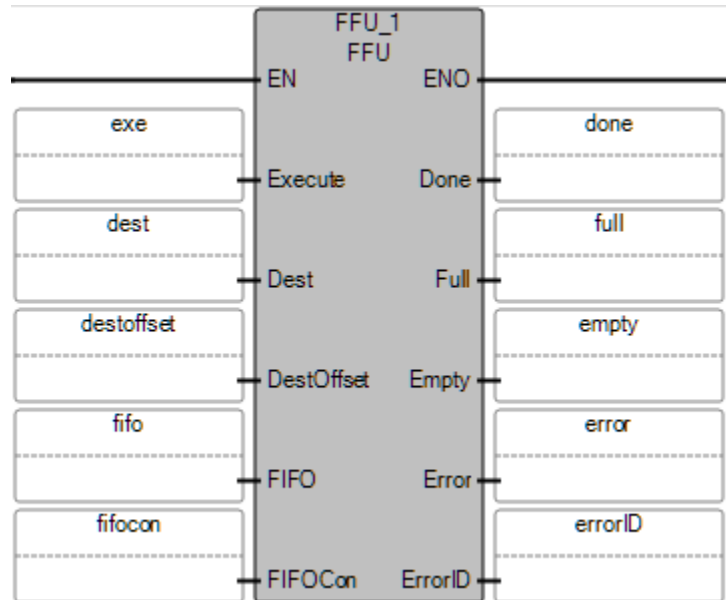

### FFU Structured Text example

```

1  FFU_1(exe, dest, destoffset, fifo, fifocon);
2  done := FFU_1.Done;
3  full := FFU_1.Full;
4  empty := FFU_1.Empty;
5  error := FFU_1.Error;
6  errorID := FFU_1.ErrorID;

```

```

FFU_1
void FFU_1(BOOL Execute, ANY_ELEMENTARY[1..1] Dest, UNT DestOffset, ANY_ELEMENTARY[1..1] FIFO, FF_FF_CON FIFOCon)
Type: FFU, RPO Unload

```

## Results

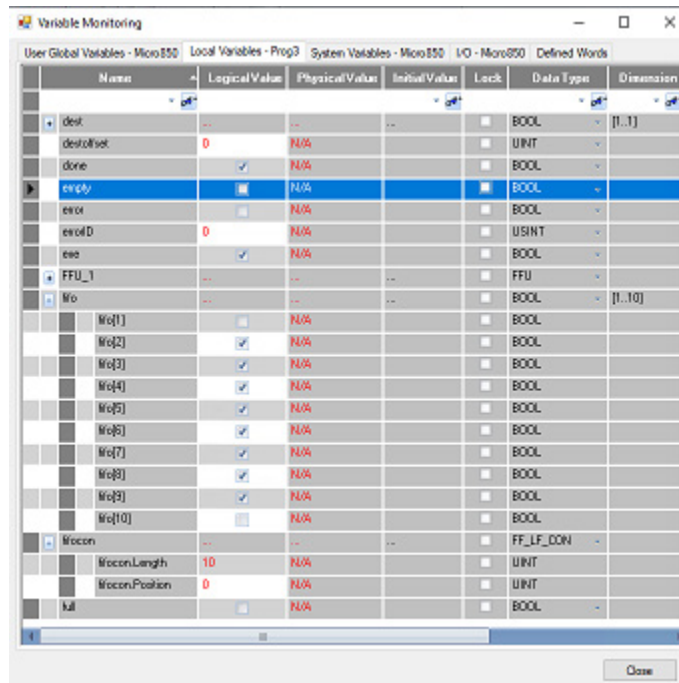

## HYSTER (hysteresis)

Boolean hysteresis on difference of reals. Compares the current value of an input with the high limit established by adding the historical amount of lag as measured by hysteresis to the expected value for an input and assessing whether the current value exceeds that limit.

Languages supported: Function Block Diagram, Ladder Diagram, Structured Text.

This instruction applies to the Micro810, Micro820, Micro830, Micro850, Micro870 controllers and Micro800 Simulator.

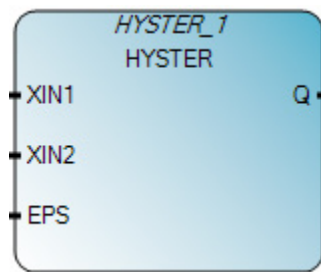

Use this table to help determine the parameter values for this instruction.

Parameter	Parameter type	Data type	Description
EN	Input	BOOL	Instruction block enable. TRUE - execute the instruction block. FALSE - do not execute the instruction block. Applies only to Ladder Diagram programs.
XIN1	Input	REAL	Any real value.
XIN2	Input	REAL	To test if the input value XIN1 has exceeded the high limit defined for this input XIN2 + EPS.

Parameter	Parameter type	Data type	Description
EPS	Input	REAL	Hysteresis value (must be greater than zero).
ENO	Output	BOOL	Enable output. Applies only to Ladder Diagram programs.
Q	Output	BOOL	The result of the HYSTER instruction. TRUE - The input exceeded the upper limit but is not below the lower limit. FALSE - The input did not exceed the upper limit.

### HYSTER timing diagram example

In the following diagram HYSTER is used to assess the performance lag due to motor friction over a 5 second time period. The instruction is run every 10 milliseconds. During the startup phase the motor was operating less efficiently.

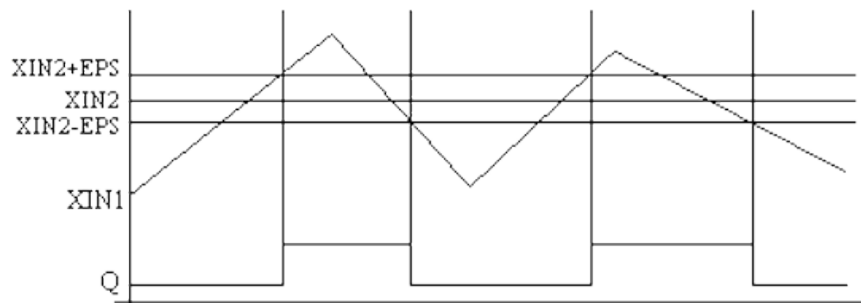

### HYSTER Function Block Diagram example

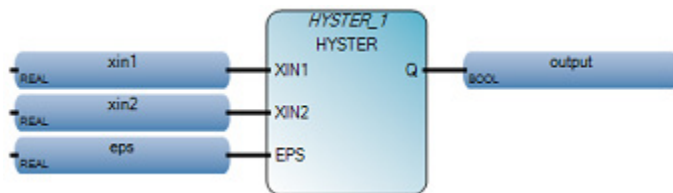

### HYSTER Ladder Diagram example

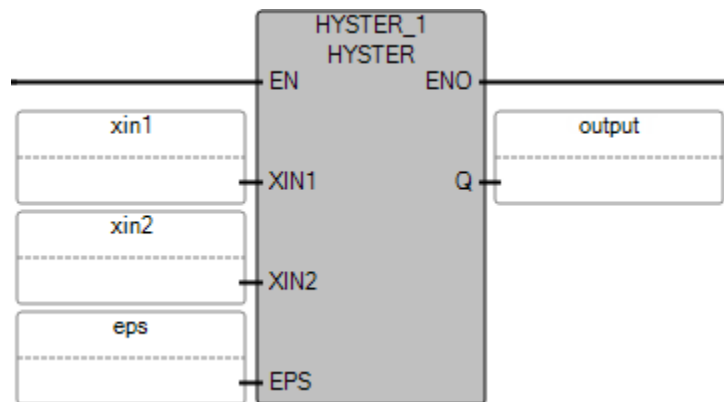

## HYSTER Structured Text example

```

HYSTER_1(
void HYSTER_1(REAL XIN1, REAL XIN2, REAL EPS)
Type : HYSTER, Boolean hysteresis on difference of reals

1  xin1 := 10.0;
2  xin2 := 1.0;
3  eps  := 1.0;
4  HYSTER_1(xin1, xin2, eps);
5  output := HYSTER_1.Q;

```

## INTEGRAL

Integrates a real value during the defined cycle time.

Operation details:

- When the INTEGRAL function block is first initialized, its initial values are not considered. Use the R1 parameter to set the initial values for a calculation.
- To prevent loss of the integrated value, the integration value is not cleared automatically when the controller transitions from PROGRAM to RUN or when the RUN parameter transitions from FALSE to TRUE. Use the R1 parameter to clear the integral value when first transitioning the controller from PROGRAM to RUN mode and when starting a new integration.
- It is recommended that the optional EN or ENO parameters are not used with this function block because the cycle time calculation becomes disrupted when EN is FALSE, resulting in an incorrect integration. If the EN or ENO parameters are used, toggle the R1 parameter with EN equal to TRUE to clear the current result and ensure correct integration.
- Integration is performed with a time base of milliseconds (that is, integrating an input of 1 with an initial value of 0 for 1 second results in a value of 1000). To convert the output of the instruction to units of seconds, divide the output by 1000.
- If the CYCLE parameter value is less than the cycle timing of the execution of the device, the sampling period is forced to the cycle timing.
- XIN sampling and function block executions occur every cycle time + Scan Time Jitter.
- For a given user program, Scan Time Jitter varies from controller to controller.
- The cycle time determines the sensitivity of the Integral function block. Changes occurring in XIN between two samplings (or within the cycle time) are not taken into account when the integral XOUT value is calculated.
- Cycle time and Scan Time Jitter both contribute to the overall inaccuracy of Integral output as shown in the XIN in sync with the function block execution example and the XIN not in sync with function block execution example.



Languages supported: Function Block Diagram, Ladder Diagram, Structured Text.

This instruction applies to the Micro810, Micro820, Micro830, Micro850, Micro870 controllers and Micro800 Simulator.

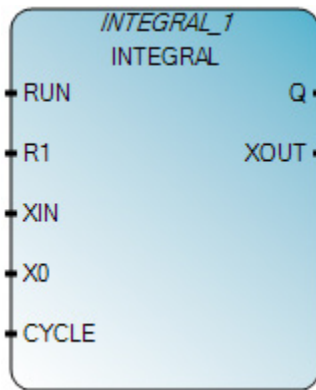

Use this table to help determine the parameter values for this instruction.

Parameter	Parameter type	Data type	Description
RUN	Input	BOOL	Mode: TRUE = integrate / FALSE = hold.
R1	Input	BOOL	Overriding reset.
XIN	Input	REAL	Input: any real value.
XO	Input	REAL	Initial value.
CYCLE	Input	TIME	Sampling period. Possible values range from 0ms to 49d17h2m47s294ms.
Q	Output	BOOL	Not R1.
XOUT	Output	REAL	Integrated output.

### INTEGRAL Function Block Diagram example

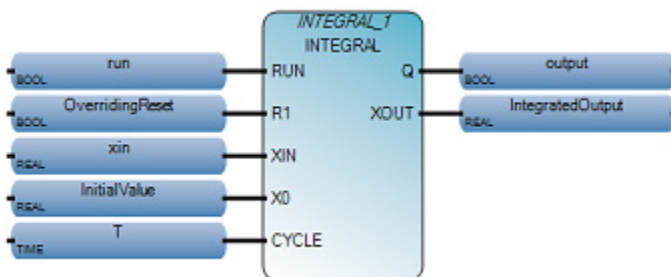

### INTEGRAL Ladder Diagram example

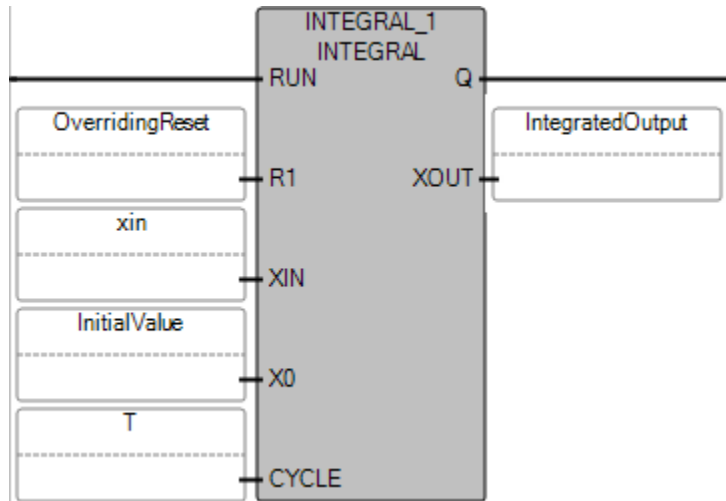

### INTEGRAL Structured Text example

```

INTEGRAL_1
void INTEGRAL_1(BOOL RUN, BOOL R1, REAL XIN, REAL X0, TIME CYCLE)
Type : INTEGRAL, Integration over time

1 run := TRUE;
2 xin := 10.0;
3 InitialValue := 5.0;
4 T := T#10s;
5 INTEGRAL_1(run, OverridingReset, xin, InitialValue, T);
6 output := NOT OverridingReset;
7 IntegratedOutput := INTEGRAL_1.XOUT;
    
```

(\* ST Equivalence: INTEGRAL1 is an instance of a INTEGRAL block \*)

```

INTEGRAL1(manual_mode, NOT(manual_mode), sensor_value,
init_value, t#100ms);
controlled_value := INTEGRAL1.XOUT;
    
```

### Results

Name	Logical Value	Physical Value	Initial Value	Lock	Data Type
InitialValue	5.0	N/A		<input type="checkbox"/>	REAL
INTEGRAL_1	...	...	...	<input type="checkbox"/>	INTEGRAL
IntegratedOutput	2268270	N/A		<input type="checkbox"/>	REAL
output	<input checked="" type="checkbox"/>	N/A		<input type="checkbox"/>	BOOL
OverridingReset	<input type="checkbox"/>	N/A		<input type="checkbox"/>	BOOL
run	<input checked="" type="checkbox"/>	N/A		<input type="checkbox"/>	BOOL
T	T#10s	N/A		<input type="checkbox"/>	TIME
xin	10.0	N/A		<input type="checkbox"/>	REAL

### XIN in sync with function block execution example

The following images show the effect of Scan Time Jitter on the XOUT value:

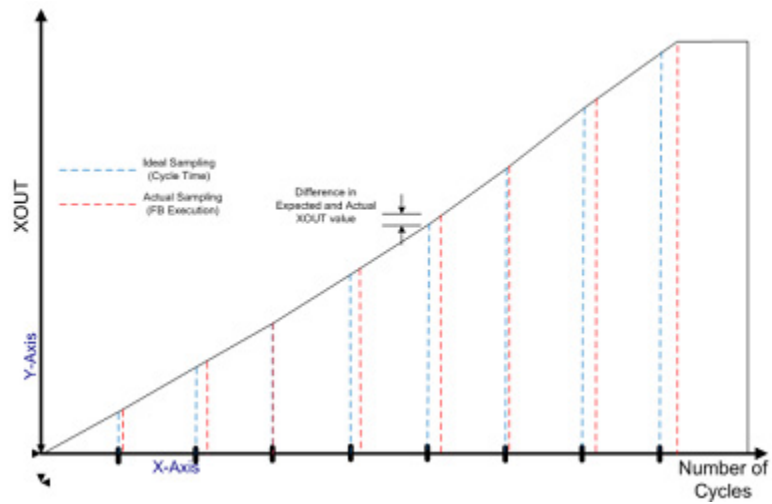
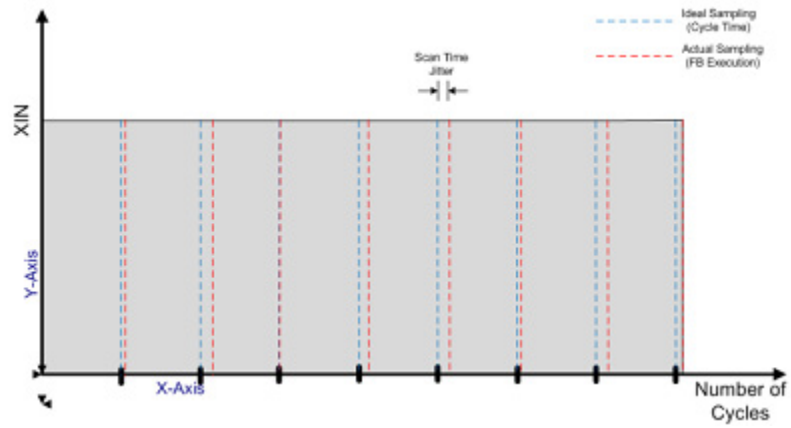

### XIN not in sync with function block execution example

The following images show an example in which an error is introduced in the XOUT value of an Integral function block:

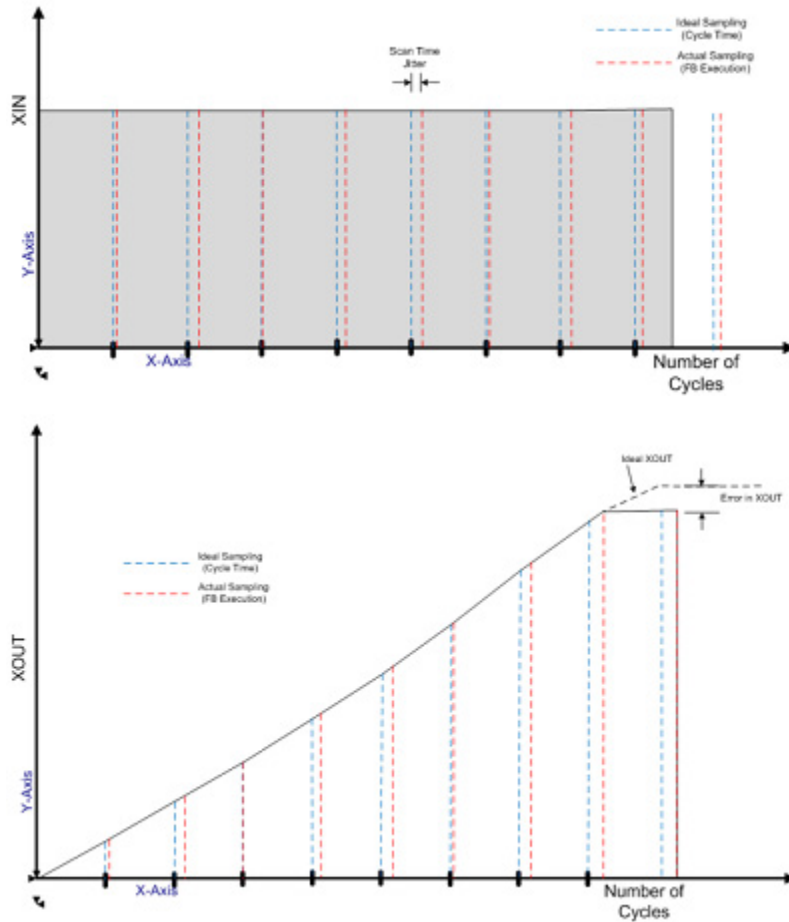

## AND

Performs a boolean AND operation between two or more values.

Languages supported: Function Block Diagram, Ladder Diagram, Structured Text.

This instruction applies to the Micro810, Micro820, Micro830, Micro850, Micro870 controllers and Micro800 Simulator.

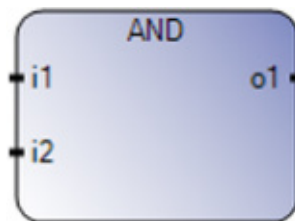

Use this table to help determine the parameter values for this instruction.

Parameter	Parameter Type	Data Type	Description
i1	Input	BOOL	Value in Boolean data type.
i2	Input	BOOL	Value in Boolean data type.
o1	Output	BOOL	Result of the Boolean AND operation of the input values.

### AND Structured Text example

(\* ST equivalence: \*)

```
bo10 := bi101 AND NOT (bi102);
bo5  := (bi51 AND bi52) AND bi53;
```

### LFL(LIFO load)

LFL instruction is used to load the data (8 bit, 16 bit, 32 bit and 64 bit) into a user-created array called LIFO stack. LFL and [LFU](#) on [page 503](#) instructions are used in pairs.

Languages supported: Function Block Diagram, Ladder Diagram, Structured Text.

This instruction applies to the Micro820, Micro830, Micro850, Micro870 controllers and Micro800 Simulator.

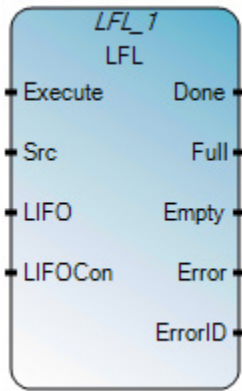

Use this table to help determine the parameter value for this instructions.

Parameter	Parameter Type	Data Type	Description
Execute	Input	BOOL	Instruction block enable. TRUE - If rising edge is detected, start the LFL operation. FALSE - Rising edge is not detected.
Src	Input	ANY_ELEMENTARY	The Src operand is the address of the value to fill the current available position in the LIFO stack. Element data types supported: <ul style="list-style-type: none"> <li>• DWORD, REAL, TIME, DWORD, REAL, TIME, DATE, LWORD, ULINT, LINT, LREAL, BOOL, SINT, USINT, BYTE, INT, UINT, WORD, DINT, UDINT.\</li> <li>• Array element such as Array [1] or Array[Index].</li> <li>• String is not supported</li> </ul>
LIFO	Input	ANY_ELEMENTARY	The starting address of the stack. LIFO must be configured the same for the LFL and LFU instructions. Element data types supported: <ul style="list-style-type: none"> <li>• DWORD, REAL, TIME, DWORD, REAL, TIME, DATE, LWORD, ULINT, LINT, LREAL, BOOL, SINT, USINT, BYTE, INT, UINT, WORD, DINT, UDINT.</li> <li>• Only single dimension is supported.</li> <li>• String is not supported.</li> </ul>
LIFOCon	Input	FF_LF_CON	LIFO configuration and control. The same configuration must be configured for LFL and LFU instructions. Use the FF_LF_CON data type to configure Position and Length.
Full	Output	BOOL	Indicates when the LIFO stack is full. TRUE - When Length is equal to Position. FALSE - When Position is greater than or equal to zero and less than Length.

Parameter	Parameter Type	Data Type	Description
Empty	Output	BOOL	Indicates when the LIFO stack is empty. TRUE - When Position equals zero. FALSE - When Position is not equal to zero.
Error	Output	BOOL	Indicate the existence of an error condition. TRUE- Operation encountered an error. FALSE- Operation completed successfully or the instruction is not executing.
ErrorID	Output	USINT	A unique numeric that identifies the error. The errors are defined in the LFL error codes.
Done	Output	BOOL	Indicate when operation is completed. TRUE - Operation completed successfully. FALSE - Operation encountered an error condition or the LFL instruction is not executing.

### LFL Function Block Diagram example



### LFL Ladder Diagram example

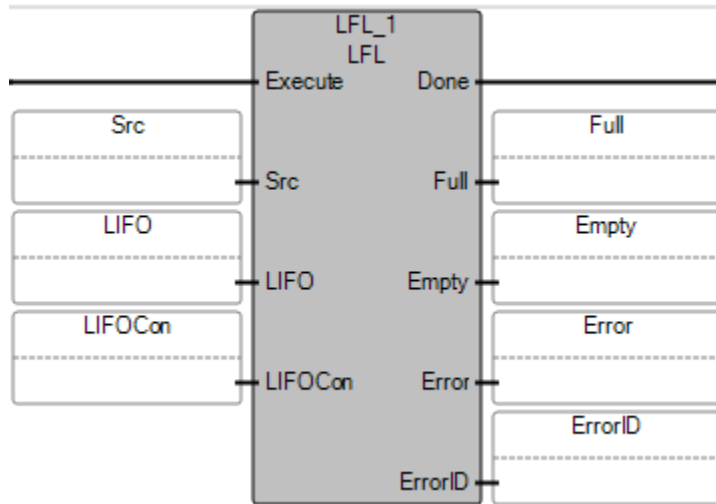

## LFL Structured Text example

```
LFL_1 |
void LFL_1(BOOL Execute, ANY_ELEMENTARY Src, ANY_ELEMENTARY[1..1] LIFO, FF_LF_CON LIFOCon)
Type : LFL, LIFO Load
```

```
1 LFL_1(exe, Src, fifo, fifocon);
2 Done:=LFL_1.Done;
3 Full:=LFL_1.Full;
4 Empty:=LFL_1.Empty;
5 Error:=LFL_1.Error;
6 ErrorID:=LFL_1.ErrorID;
```

## LFU(LIFO unload)

LFU instruction unloads data (8 bit, 18 bit, 32 bit, 64 bit) from a user - created array called LIFO stack. LFU and [LFL](#) on [page 501 instructions](#) are used in pairs.

Languages supported: Function Block Diagram, Ladder Diagram, Structured Text.

This instruction applies to the Micro820, Micro830, Micro850, Micro870 controllers and Micro800 Simulator.



Use this table to help determine the parameter value for this instructions.

Parameter	Parameter Type	Data Type	Description
Execute	Input	BOOL	Instruction block enable. TRUE - If rising edge is detected, start the LFU operation. FALSE - Rising edge is not detected.
Dest	Input	ANY_ELEMENTARY	Holds the value that exists in the LIFO stack. Elementary data types supported for Dest: <ul style="list-style-type: none"> <li>• DWORD, REAL, TIME, DATE, LWORD, ULINT, LINT, LREAL, BOOL, SINT, USINT, BYTE, INT, UINT, WORD, DINT, UDINT.</li> <li>• Sting is not supported.</li> <li>• Only supports single dimension arrays such as Array[1] or Array[Index].</li> </ul>
DestOffset	Input	UINT	Destination element offset. Element offset if destination is array data type, otherwise offset should be set to 0. For array data type, to unload to the first element, the offset should be set as 0.

Parameter	Parameter Type	Data Type	Description
LIFO	Input	ANY_ELEMENTARY	The starting address of the stack. LIFO must be configured the same for the LFL and LFU instructions. Element data types supported: <ul style="list-style-type: none"> <li>• DWORD, REAL, TIME, DWORD, REAL, TIME, DATE, LWORD, ULINT, LINT, LREAL, BOOL, SINT, USINT, BYTE, INT, UINT, WORD, DINT, UDINT.</li> <li>• Only single dimension is supported.</li> <li>• String is not supported.</li> </ul>
LIFOCon	Input	FF_LF_CON	LIFO configuration and control. The same configuration must be configured for LFL and LFU instructions. Use the FF_LF_CON data type to configure Position and Length.
Full	Output	BOOL	Indicates when the LIFO stack is full. TRUE - When Length is equal to Position. FALSE - When Position is greater than or equal to zero and less than Length.
Error	Output	BOOL	Indicate the existence of an error condition. TRUE - Operation encountered an error. FALSE - Operation completed successfully or the instruction is not executing.
ErrorID	Output	USINT	A unique numeric that identifies the error. The errors are defined in the LFU error codes.
Done	Output	BOOL	Indicate when operation is completed. TRUE - Operation completed successfully. FALSE - Operation encountered an error condition or the LFU instruction is not executing.

**LFU Function Block Diagram example**

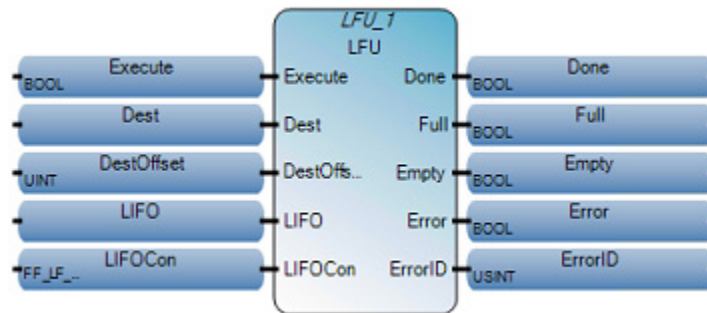



## LFU Ladder Diagram example

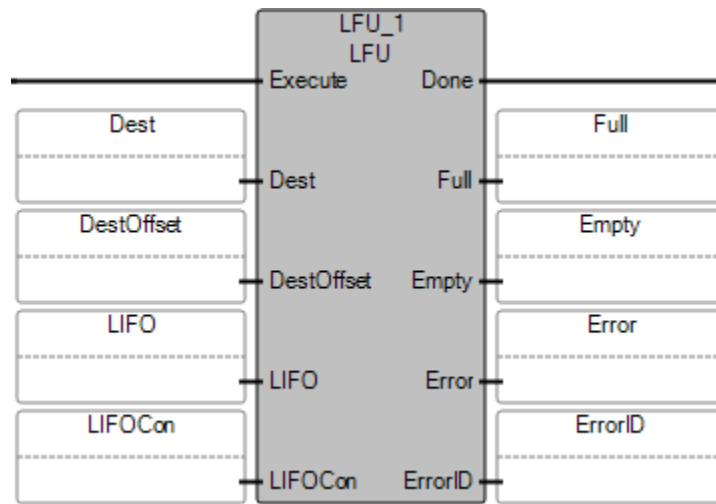

## LFU Structured Text example

```
LFU_1|
void LFU_1(BOOL Execute, ANY_ELEMENTARY[1..1] Dest, UINT DestOffset, ANY_ELEMENTARY[1..1] LIFO, FF_LF_CON LIFOCon)
Type: LFU, LIFO Unload
```

```
1 LFU_1(exe, Dest, destoffset, lifo, lifocon);
2 Done:=LFU_1.Done;
3 Full:=LFU_1.Full;
4 Empty:=LFU_1.Empty;
5 Error:=LFU_1.Error;
6 ErrorID:=LFU_1.ErrorID;
```

## PWM (Pulse Width Modulation)

Turns the PWM (Pulse Width Modulation) output for a configured PWM channel ON or OFF.

This instruction block is used with Micro820 2080-LC20-20QBB controllers and supports one PWM channel using the embedded output channel 6.

Languages supported: Function Block Diagram, Ladder Diagram, Structured Text.

This instruction applies only to the Micro820 controller.

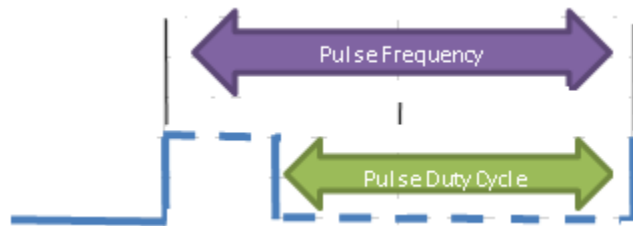
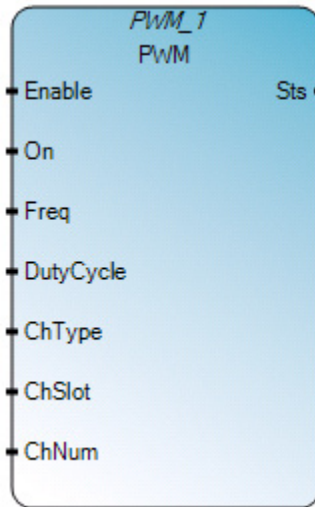

Use this table to help determine the parameter values for this instruction.

Parameter	Parameter type	Data type	Description
Enable	Input	BOOL	Instruction block enable. This level is instruction block triggered. TRUE - Update Sts. PWM is made active or inactive depending on the On input parameter and valid configuration. FALSE - Sts is only updated. PWM state (active or inactive) is not affected.
On	Input	BOOL	Turns the PWM output ON/Active or OFF/Inactive. TRUE - PWM output is active or continues to be active with latest valid configuration. Output LED is ON when PWM is active, even if duty cycle is set to 0%. FALSE - PWM output is inactive if configuration is also valid.
Freq	Input	UDINT	Pulse Frequency. • 1 - 100000 Hz
DutyCycle	Input	UINT	Pulse Duty Cycle. • 0 - 1000 (0% - 100%)
ChType	Input	UINT	Channel Type • 0 - Embedded • 1 - Plugin • 2 - Expansion
ChSlot	Input	UINT	Channel Slot • 0 - Embedded
ChNum	Input	UINT	Channel Number • 0 - PWM CHO
ENO	Output	BOOL	Enable output. Applies only to Ladder Diagram programs.

Parameter	Parameter type	Data type	Description
Sts	Output	UINT	PWM status codes: <ul style="list-style-type: none"> <li>• 00 - Function block not enabled (no operation.)</li> <li>• 01 - PWM configuration successful.</li> <li>• 02 - Invalid duty cycle.</li> <li>• 03 - Invalid Frequency.</li> <li>• 04 - Invalid Channel Type.</li> <li>• 05 - Invalid Channel Slot.</li> <li>• 06 - Invalid Channel Number.</li> <li>• 07 - Invalid Catalog. PWM feature is not supported in the catalog being used.</li> </ul>

### PWM Function Block Diagram example

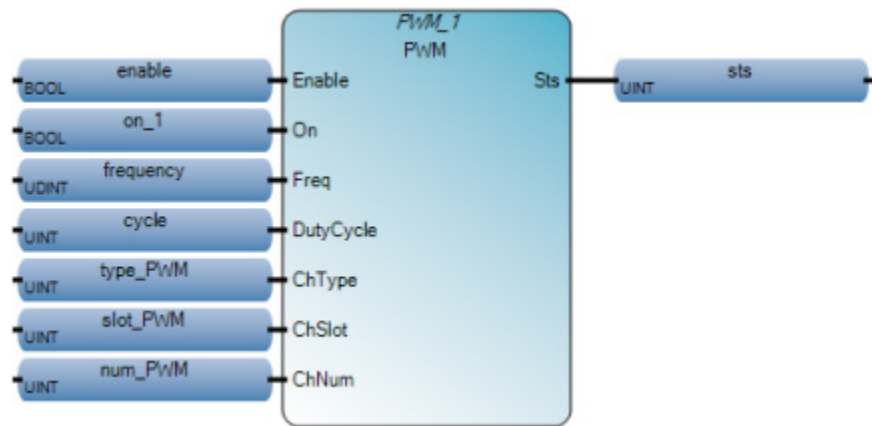

### PWM Ladder Diagram example

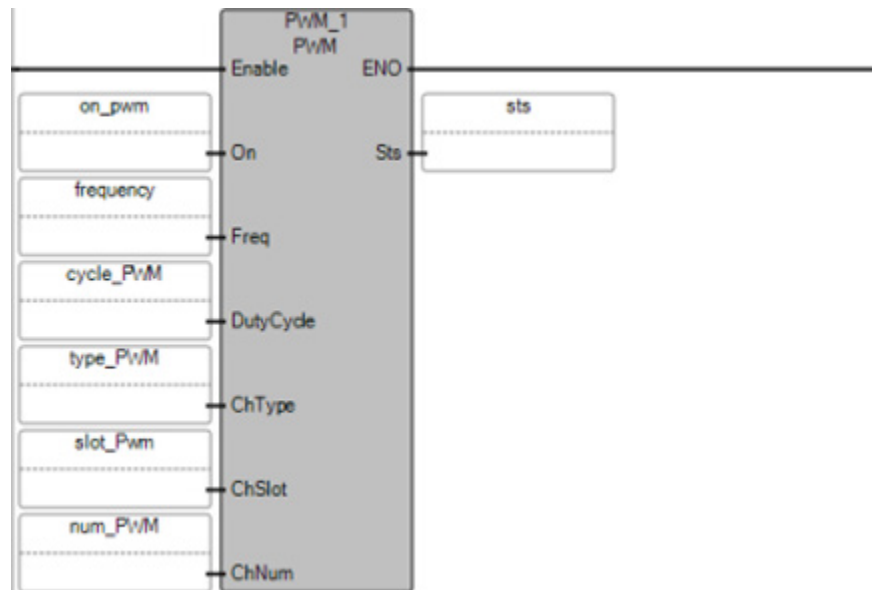

### PWM Structured Text example

```

PWM_1
void PWM_1(BOOL Enable, BOOL On, UDINT Freq, UINT DutyCycle, UINT ChType, UINT ChSlot, UINT ChNum)
Type: PWM, Enable PWM output.

1 PWM (EN, Enable, On, Freq, DutyCycle, ChType, ChSlot, ChNum);
2 output := PWM.ENO
3 sts := PWM.Sts
    
```

### SCALER (scale)

Languages supported: Function Block Diagram, Ladder Diagram, Structured Text.

This instruction applies to the Micro810, Micro820, Micro830, Micro850, Micro870 controllers and Micro800 Simulator.,

Use this table to help determine the parameter values for this instruction.

Parameter	Parameter type	Data type	Description
EN	Input	BOOL	Instruction block enable. TRUE - execute the scaling equation. FALSE - there is no scaling equation. Applies only to Ladder Diagram programs.
Input	Input	REAL	Input signal. Input is not limited by InputMin and InputMax. To limit Input, a LIM_ALARM instruction is needed to condition Input before it's entered to the SCALER instruction.
InputMin	Input	REAL	Determine the slope and offset value.
InputMax	Input	REAL	Determine the slope and offset value.
OutputMin	Input	REAL	Determine the slope and offset value.
OutputMax	Input	REAL	Determine the slope and offset value.
Output	Output	REAL	Scaled Output. Output is not clamped between OutputMin and OutputMax.
ENO	Output	BOOL	Enable output. Applies only to Ladder Diagram programs.

### SCALER Function Block Diagram example

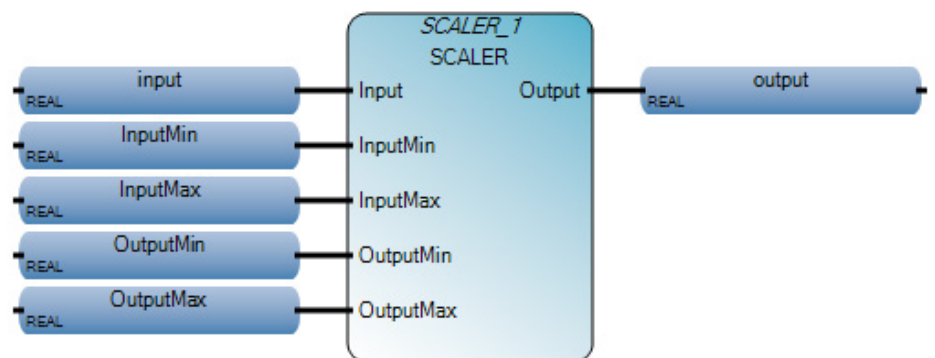

## SCALER Ladder Diagram example

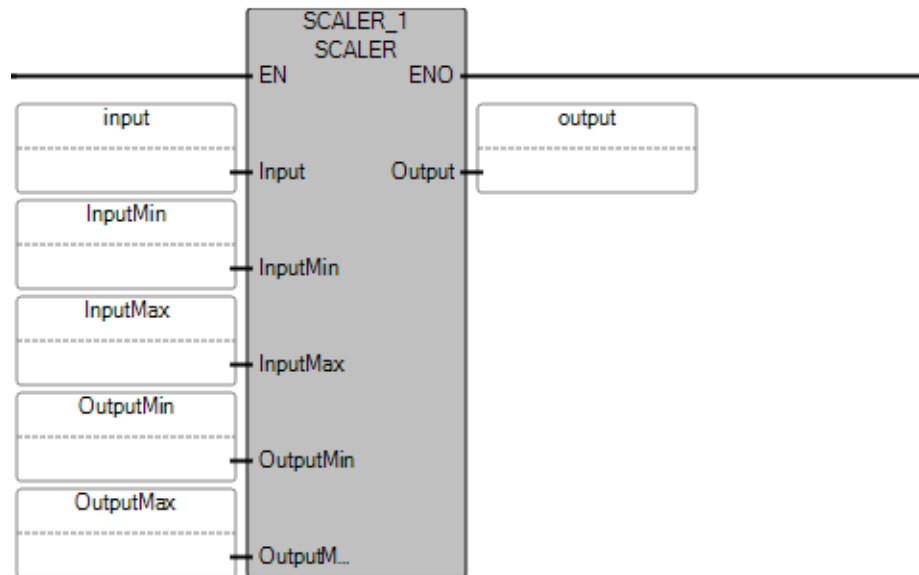

## SCALER Structured Text example

```
SCALER_1(
  void SCALER_1(REAL Input, REAL InputMin, REAL InputMax, REAL OutputMin, REAL OutputMax)
  Type : SCALER, Scale input value according to output range.
```

```
1 input := 10.0;
2 InputMin := 5.0;
3 InputMax := 15.0;
4 OutputMin := 1.0;
5 OutputMax := 10.0;
6 SCALER_1(input, InputMin, InputMax, OutputMin, OutputMax);
7 output := SCALER_1.Output;
```

(\* ST equivalence: SCALER1 is an instance of SCALER block \*)

```
SCALER1(Signal_In, 4.0, 20.0 , 0.0 , 150.0 ) ;
Out_Temp := SCALER1.Output ;
```

## Results

Name	Logical Value	Physical Value	Initial Value	Lock	Data Type
SCALER_1	...	...	...	<input type="checkbox"/>	SCALER
OutputMin	1.0	N/A		<input type="checkbox"/>	REAL
OutputMax	10.0	N/A		<input type="checkbox"/>	REAL
output	5.5	N/A		<input type="checkbox"/>	REAL
InputMin	5.0	N/A		<input type="checkbox"/>	REAL
InputMax	15.0	N/A		<input type="checkbox"/>	REAL
input	10.0	N/A		<input type="checkbox"/>	REAL

## STACKINT (stack integers)

Manages a stack of integer values.

Operation details:

- STACKINT includes a rising edge detection for both PUSH and POP commands. The maximum size of the stack is 128. The OFLO value is valid only after a reset (R1 has been set to TRUE at least once and back to FALSE).
- The application defined stack size (N) cannot be less than 1 or greater than 128.
  - If  $N < 1$ , STACKINT assumes a size of 1.
  - If  $N > 128$ , STACKINT assumes a size of 128.

Languages supported: Function Block Diagram, Ladder Diagram, Structured Text.

This instruction applies to the Micro810, Micro820, Micro830, Micro850, Micro870 controllers and Micro800 Simulator.

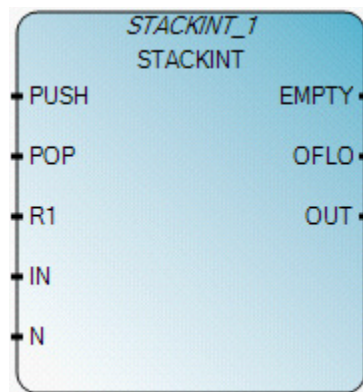

Use this table to help determine the parameter values for this instruction.

Parameter	Parameter type	Data type	Description
-----------	----------------	-----------	-------------

Parameter	Parameter type	Data type	Description
PUSH	Input	BOOL	TRUE - Rising edge detected, on PUSH command. Adds the IN value on the top of the stack. FALSE - Rising edge not detected on PUSH command.
POP	Input	BOOL	TRUE - Rising edge detected, on PUSH command. Deletes the last value pushed to the top of the stack. FALSE - Rising edge not detected on POP command.
R1	Input	BOOL	TRUE - Resets the stack to its empty state. FALSE - No reset.
IN	Input	DINT	Pushed value.
N	Input	DINT	Application defined stack size. The maximum size of the stack is 128
EMPTY	Output	BOOL	TRUE - the stack is empty. FALSE - the stack contains values.
OFLO	Output	BOOL	TRUE - Overflow, the stack is full and R1 has been set to TRUE at least once and back to FALSE. FALSE - the stack size is 128 or less. No overflow.
OUT	Output	DINT	Value at the top of the stack. OUT equals 0 when OFLO is TRUE.

### STACKINT Function Block Diagram example

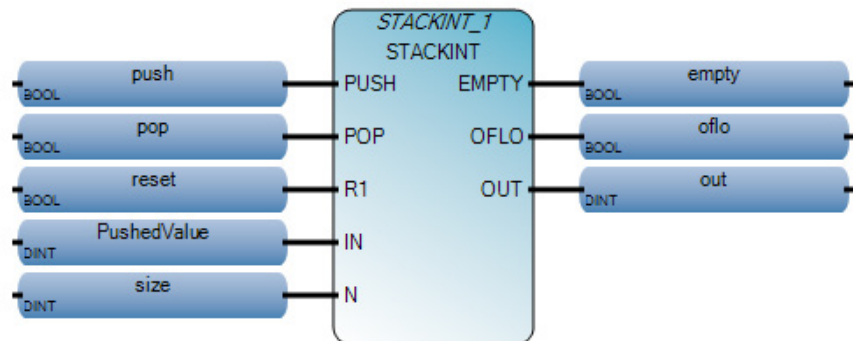

### STACKINT Ladder Diagram example

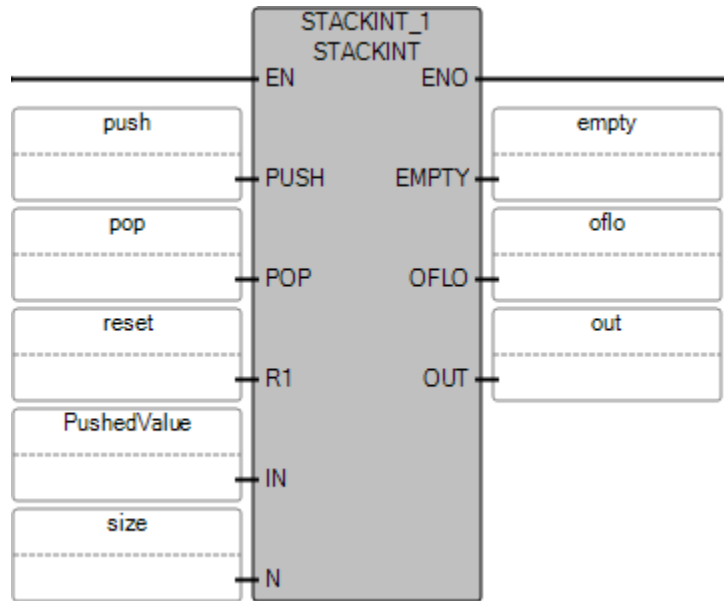

### STACKINT Structured Text example

```
STACKINT_1(
void STACKINT_1(BOOL PUSH, BOOL POP, BOOL R1, DINT IN, DINT N)
Type : STACKINT, Stack of integer analogs
```

```
1 PushedValue := 5;
2 size := 10;
3 STACKINT_1(push, pop, reset, PushedValue, size);
4 empty := STACKINT_1.EMPTY;
5 oflo := STACKINT_1.OFLO;
6 out := STACKINT_1.OUT;
```

(\* ST Equivalence: STACKINT1 is an instance of a STACKINT block \*)

```
STACKINT1(err_detect, acknowledge, manual_mode,
err_code, max_err);
appli_alarm := auto_mode AND NOT(STACKINT1.EMPTY);
err_alarm := STACKINT1.OFLO;
last_error := STACKINT1.OUT;
```



## Results

Name	Logical Value	Physical Value	Initial Value	Lock	Data Type
empty	<input type="checkbox"/>	N/A		<input type="checkbox"/>	BOOL
oflo	<input type="checkbox"/>	N/A		<input type="checkbox"/>	BOOL
out	5	N/A		<input type="checkbox"/>	DINT
pop	<input type="checkbox"/>	N/A		<input type="checkbox"/>	BOOL
push	<input checked="" type="checkbox"/>	N/A		<input type="checkbox"/>	BOOL
PushedValue	5	N/A		<input type="checkbox"/>	DINT
reset	<input type="checkbox"/>	N/A		<input type="checkbox"/>	BOOL
size	10	N/A		<input type="checkbox"/>	DINT
STACKINT_1	...	...	...	<input type="checkbox"/>	STACKINT

## SCL

Converts an unscaled REAL input value to a REAL floating point value in engineering units and includes alarming and limiting of the output.

Languages supported: Function Block Diagram, Ladder Diagram, Structured Text.

This instruction applies to the Micro820, Micro830, Micro850, Micro870 controllers and Micro800 Simulator.

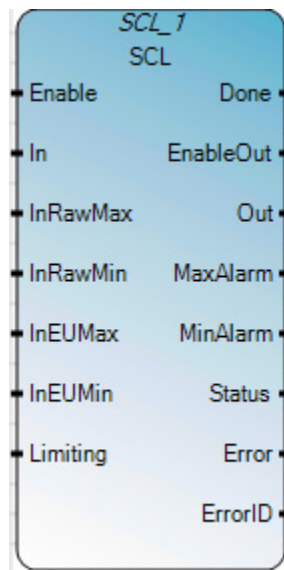

Use this table to help determine the parameter values for this instruction.

Parameter	Parameter Type	Data Type	Description
-----------	----------------	-----------	-------------

Parameter	Parameter Type	Data Type	Description
Enable	Input	BOOL	<p>TRUE - Rising Edge detected.</p> <ul style="list-style-type: none"> <li>If <math>\text{InRawMin} \geq \text{InRawMax}</math>, Status.0 and Status.1 bits are set to 1. Done is cleared, MaxAlarm and MinAlarm are cleared. Error is set to TRUE and ErrorID is set to 1.</li> <li>Else Out is calculated first. Then alarm conditions are verified. If MaxAlarm is set, MinAlarm is cleared and vice versa. Then if limiting is set, Out will be in the range of InEUMin and InEUMax. Then Done bit is set to TRUE. Status bits are set to 0. Error and ErrorID are set to 0.</li> <li>The calculated Out value is compared against NAN (Not a Number). If NAN is the Out value, EnableOut is cleared. Done is cleared if fault condition is set.</li> </ul> <p>FALSE - Rising Edge not detected.</p> <ul style="list-style-type: none"> <li>The instruction does not execute.</li> <li>The outputs are not updated except Error, ErrorID, EnableOut and Done are set to 0.</li> </ul>
In	Input	REAL	<p>The analog signal input.</p> <p>Valid = any float</p> <p>Default = 0.0</p>
InRawMax	Input	REAL	<p>The maximum value attainable by the input to the instruction. If <math>\text{InRawMax} \leq \text{InRawMin}</math>, the instruction sets the appropriate bit in Status and Error. ErrorID are updated. Out updating stops.</p> <p>Valid = <math>\text{InRawMax} &gt; \text{InRawMin}</math></p> <p>Default = 0.0</p>
InRawMin	Input	REAL	<p>The minimum value attainable by the input to the instruction. If <math>\text{InRawMin} \geq \text{InRawMax}</math>, the instruction sets the appropriate bit in Status and Error. ErrorID are updated. Out updating stops.</p> <p>Valid = <math>\text{InRawMin} &lt; \text{InRawMax}</math></p> <p>Default = 0.0</p>
InEUMax	Input	REAL	<p>The scaled value of the input corresponding to InRawMax.</p> <p>Valid = any real value</p> <p>Default = 0.0</p>
InEUMin	Input	REAL	<p>The scaled value of the input corresponding to InRawMin.</p> <p>Valid = any real value</p> <p>Default = 0.0</p>
Limiting	Input	BOOL	<p>Limiting selector.</p> <p>TRUE - Out is limited between InEUMin and InEUMax.</p>
Done	Output	BOOL	<p>Indicates when the operation is completed.</p> <p>TRUE - the operation completed successfully.</p> <p>FALSE - the operation encountered an error condition or Enable is set to FALSE.</p>
EnableOut	Output	BOOL	<p>Indicates if the instruction is enabled. Sets to False if Out overflows.</p>
Out	Output	REAL	<p>Represents the scaled value of the analog input.</p>
MaxAlarm	Output	BOOL	<p>The maximum input alarm indicator.</p> <p>This value is set to TRUE when <math>\text{Input} &gt; \text{InRawMax}</math>.</p>
MinAlarm	Output	BOOL	<p>The minimum input alarm indicator.</p> <p>This value is set to TRUE when <math>\text{Input} &lt; \text{InRawMin}</math>.</p>
Status	Output	DINT	<p>Status of the Function block.</p> <p>InstructFault (Status.0)</p> <p>It will be set when detected the instruction's execution errors. This is not the minor or major controller error. Check the remaining status bits to determine what has occurred.</p> <p>InRawRangeInv (Status.1)</p> <p><math>\text{InRawMin} \geq \text{InRawMax}</math></p> <p>Status.3 to Status.31 are reserved for future usage and their value is 0.</p>

Parameter	Parameter Type	Data Type	Description
Error	Output	BOOL	Indicates the existence of an error condition. TRUE - operation encountered an error. FALSE - operation completed successfully or the instruction is not executing.
ErrorID	Output	BOOL	A unique numeric that identifies the error. The errors are defined in the error codes.

### Error Code

ErrorID Code	Error description
1	InRawMax<= InRawMin

### SCL Function Block Diagram example

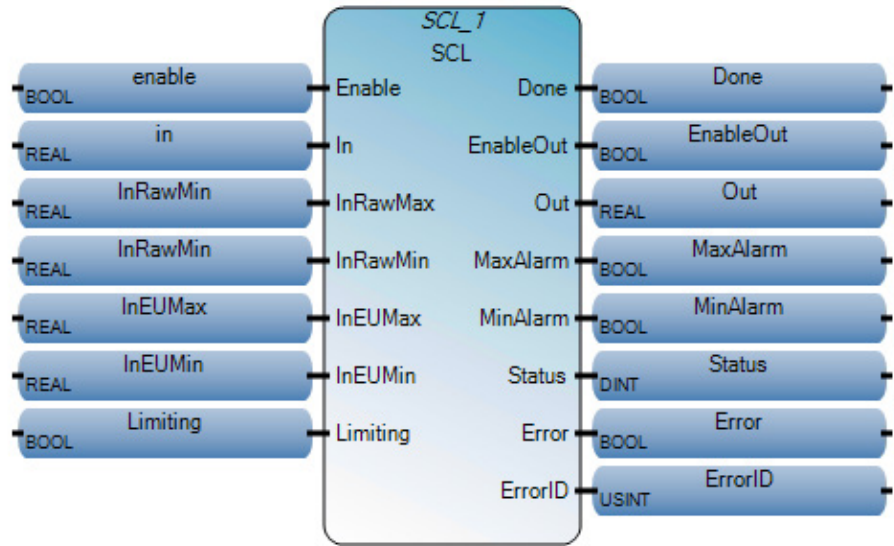

### SCL Ladder Diagram example

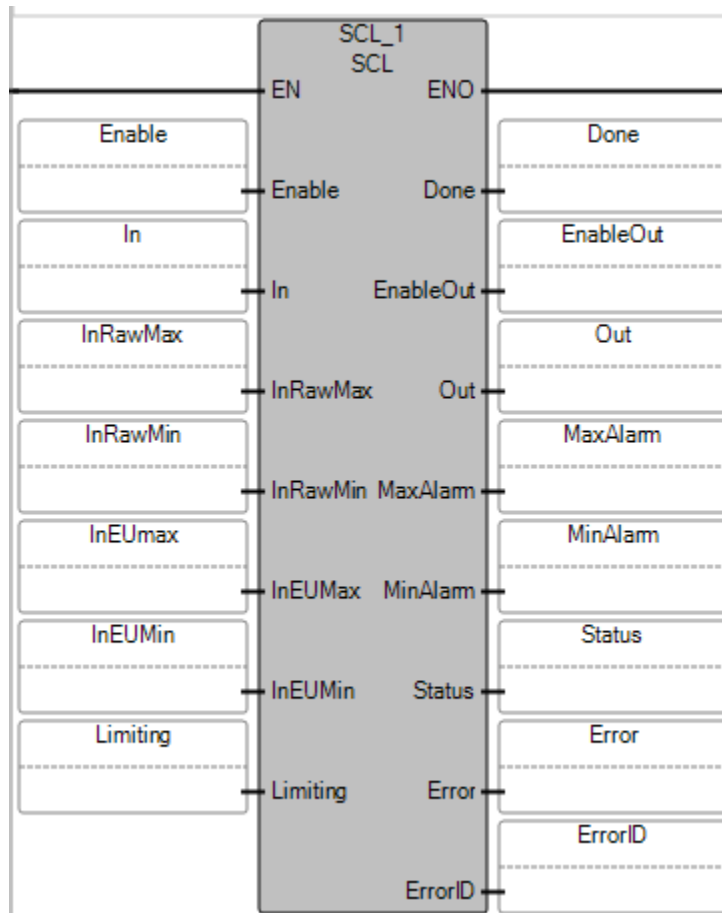

### SCL Structured Text example

```

SCL_1(
void SCL_1(BOOL Enable, REAL In, REAL InRawMax, REAL InRawMin, REAL InEUmax, REAL InEUMin, BOOL Limiting)
Type: SCL, SCL with alarm instruction converts an unscaled input value to a floating point value in engineering units

1 SCL_1(Enable, In, InRawMax, InRawMin, InEUmax, InEUMin, Limiting);
2 Done :=SCL_1.Done;
3 EnableOut :=SCL_1.EnableOut;
4 Out :=SCL_1.Out;
5 MaxAlarm :=SCL_1.MaxAlarm;
6 MinAlarm :=SCL_1.MinAlarm;
7 Status :=SCL_1.Status;
8 Error :=SCL_1.Error;
9 ErrorID :=SCL_1.ErrorID;
    
```

### SCL instruction timing diagrams examples

The following timing diagram examples describe execution scenarios for the [SCL](#) on [page 513](#) instruction.

### Successful SCL execution

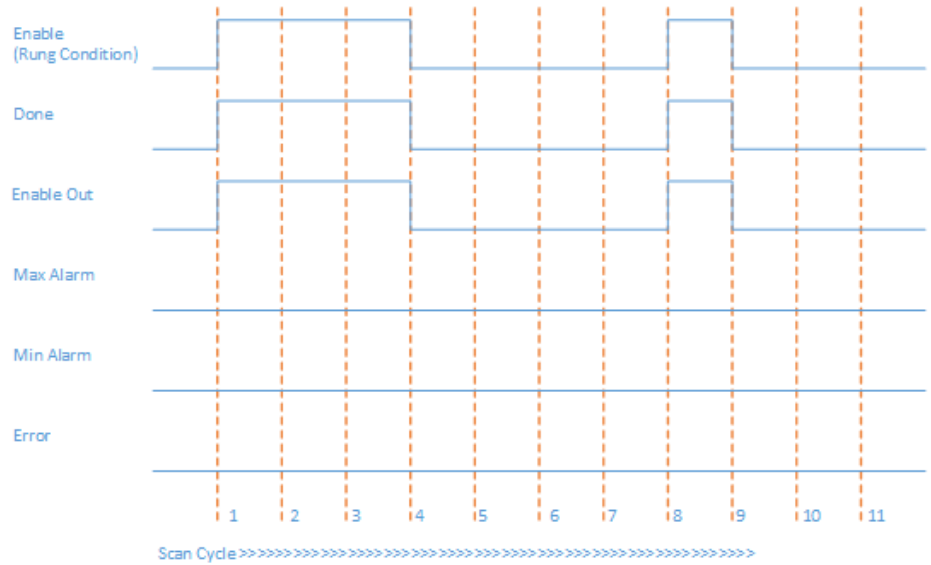

Scan Cycle	Description
1	When Enable is set to TRUE and input parameters are valid and within range, the Function Block execution starts. <ul style="list-style-type: none"> <li>• Done and EnableOut are set to TRUE.</li> <li>• Out is calculated as per given inputs.</li> <li>• MaxAlarm, MinAlarm, and Error are set to FALSE.</li> <li>• Status ErrorID and are set to 0, because there is no error generated.</li> </ul>
2, 3	No change in rung condition.
4	When Enable is set to FALSE, Function Block execution stops. <ul style="list-style-type: none"> <li>• Done, EnableOut and Error are set to FALSE.</li> <li>• ErrorID is set to 0.</li> <li>• Out, MaxAlarm, MinAlarm and Status keep their last value.</li> </ul>
5, 6, 7	No change in rung condition.
8	<ul style="list-style-type: none"> <li>• When Enable is set to TRUE and input parameters are valid and within range, the Function Block execution starts.</li> <li>• Done and EnableOut are set to TRUE.</li> <li>• Out is calculated as per given inputs.</li> <li>• MaxAlarm, MinAlarm, and Error are set to FALSE.</li> <li>• ErrorID and Status are set to 0, because there is no error generated.</li> </ul>
9	When Enable is set to FALSE, Function Block execution stops. <ul style="list-style-type: none"> <li>• Done, EnableOut and Error are set to FALSE.</li> <li>• ErrorID is set to 0.</li> <li>• Out, MaxAlarm, MinAlarm and Status keep their last value.</li> </ul>
10, 11	No change in rung condition.

### Failed SCL execution

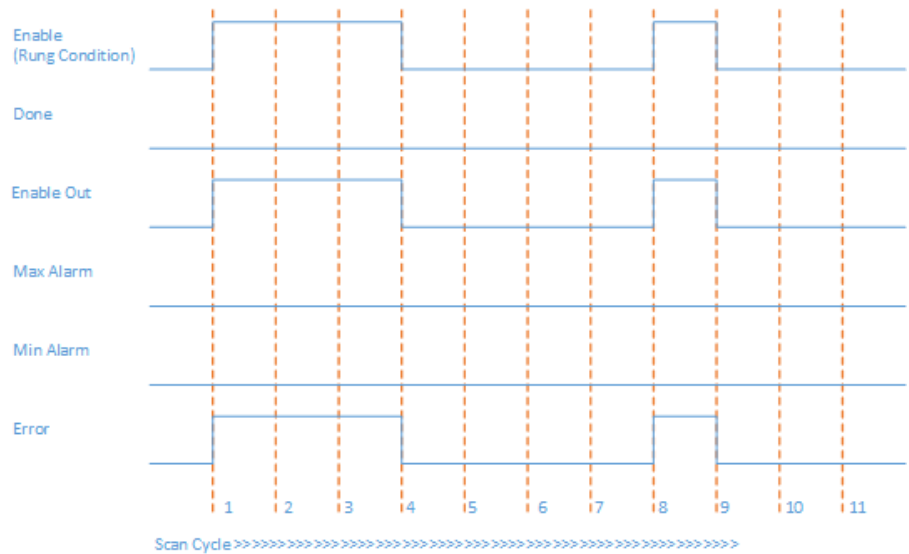

In this example, all the input parameters are valid and within range, but  $InRawMin \geq InRawMax$ . In Scan Cycle 1 and 8, when Enable is set to TRUE and the Function Block execution starts, Error is set to True and ErrorID is set to 1.

### Generation of MaxAlarm

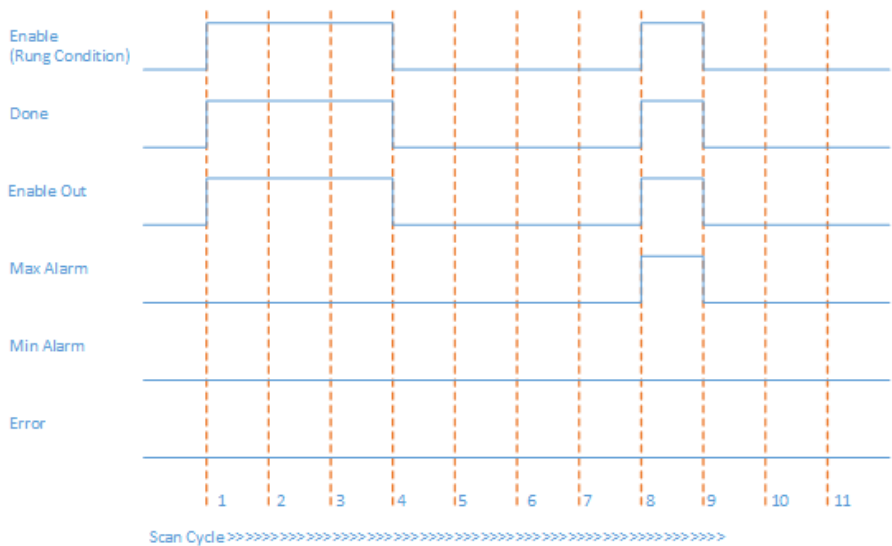

In Scan Cycle 8 of this example, all the input parameters are valid and within range, but  $In > InRawMax$ . When Enable is set to TRUE and the Function Block execution starts, MaxAlarm is set to TRUE.

### Generation of MinAlarm

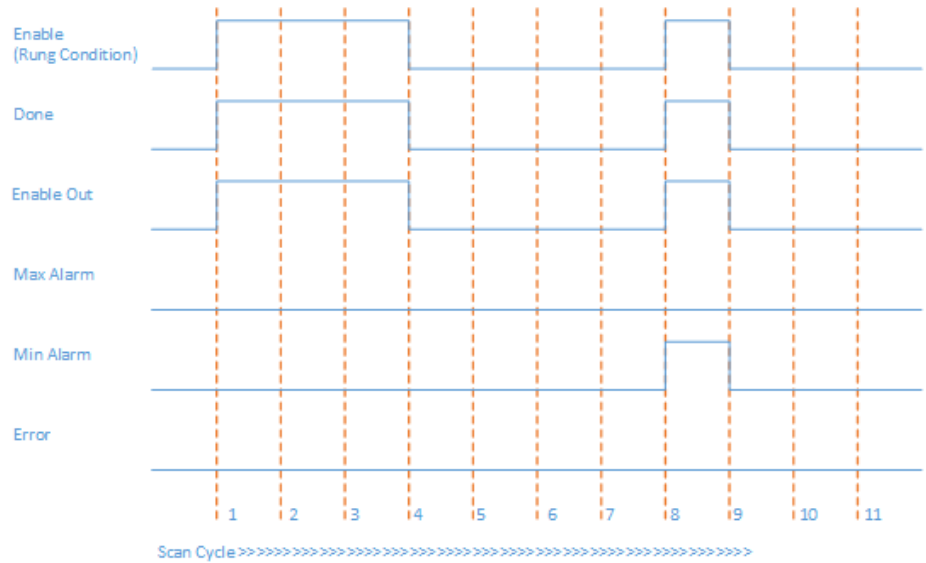

In Scan Cycle 8 of this example, all the input parameters are valid and within range, but  $In < InRawMin$ . When Enable is set to TRUE and the Function Block execution starts, MinAlarm is set to TRUE.

### Output overflow condition and input configuration error

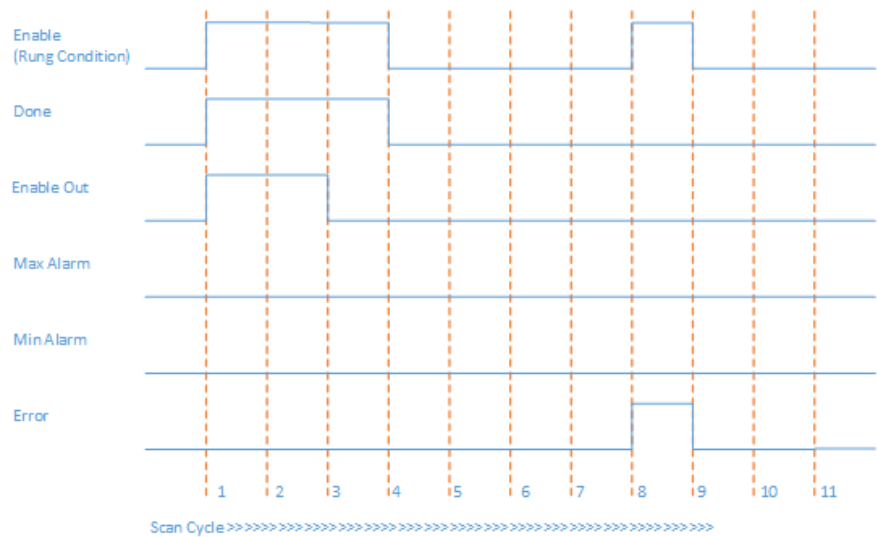

In Scan Cycle 3 of this example, Function Block input parameters are valid and within the range, but Out is overflowed because of input parameters. EnableOut is set to FALSE. Out value is invalid.

In Scan Cycle 8 of this example, Function Block input parameters are valid and within the range, but Out is overflowed because of input parameters and  $InRawMin \geq InRawMax$ , Error is set to TRUE. ErrorID is set to 1 and Status is set to 3.

**TND (stop current program)** Stops the current cycle of a user program scan. After the output scan, input scan, and housekeeping are complete, re-executes the user program from the start of the first routine.

Languages supported: Function Block Diagram, Ladder Diagram, Structured Text.

This instruction applies to the Micro810, Micro820, Micro830, Micro850, Micro870 controllers and Micro800 Simulator.



Use this table to help determine the parameter values for this instruction.

Parameter	Parameter Type	Data Type	Description
Enable	Input	BOOL	Function enable. When Enable = TRUE, perform the function. When Enable = FALSE, do not perform the function.
TND	Output	BOOL	If true, function performed. When variable monitoring is on, the monitoring variable's value is assigned to the instruction's output. When variable monitoring is off, the output variable's value is assigned to the instruction's output.

### TND Function Block Diagram example

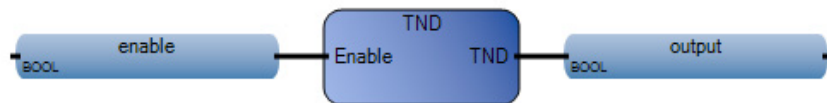

### TND Ladder Diagram example

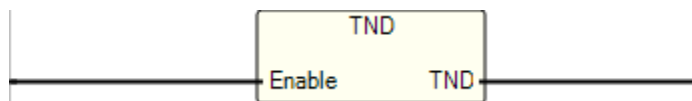

### TND Structured Text example

```
TND (
  BOOL TND(BOOL Enable)
  Abort current user program scan.
```

```
1 enable := TRUE;
2 output := TND(enable);
```

(\* ST Equivalence: \*)



TESTOUTPUT := TND(TESTENABLE) ;

### Results

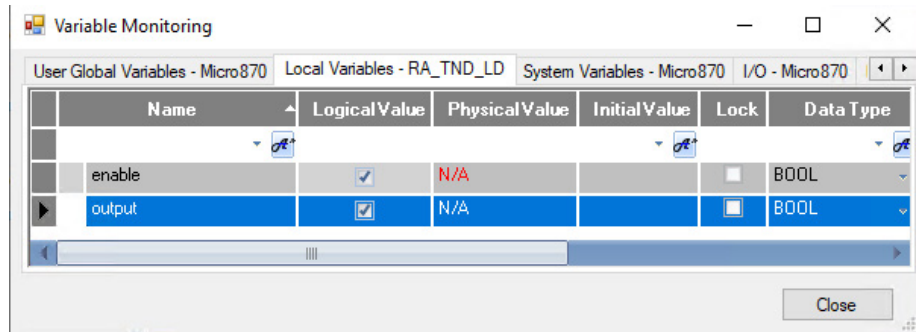

### LIMIT (limit test)

Restricts integer values to a given interval. Integer values between the minimum and maximum are unchanged. Integer values greater than the maximum are replaced with the maximum value. Integer values less than the minimum are replaced with the minimum value.

Languages supported: Function Block Diagram, Ladder Diagram, Structured Text.

This instruction applies to the Micro810, Micro820, Micro830, Micro850, Micro870 controllers and Micro800 Simulator.

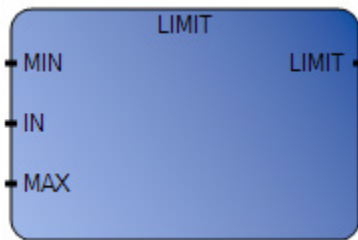

Use this table to help determine the parameter values for this instruction.

Parameter	Parameter Type	Data Type	Description
EN	Input	BOOL	Function enable. TRUE - execute current LIMIT computation. FALSE - there is no computation. Applies to Ladder Diagram programs.
MIN	Input	DINT	Minimum value supported.
IN	Input	DINT	Any signed integer value.
MAX	Input	DINT	Maximum value supported.
LIMIT	Output	DINT	Input value bounded to the supported range.
ENO	Output	BOOL	Enable output. Applies to Ladder Diagram programs.

### LIMIT Function Block Diagram example

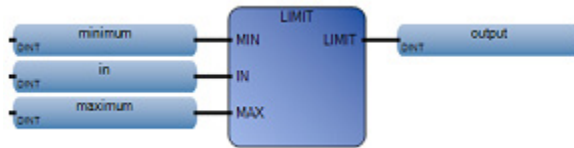

### LIMIT Ladder Diagram example

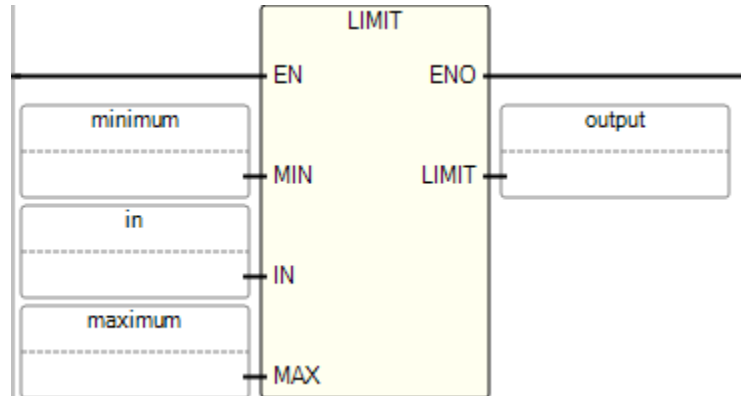

### LIMIT Structured Text example

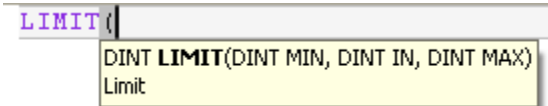

```

1 minimum := 2;
2 in := 5;
3 maximum := 10;
4 output := LIMIT(minimum, in, maximum);

```

(\* ST Equivalence: \*)

new\_value := LIMIT (min\_value, value, max\_value);

(\* bounds the value to the [min\_value..max\_value] set \*)

## Results

Variable Monitoring

User Global Variables - Micro870 | Local Variables - RA\_LIMIT\_LD | System Variables - Micro870 | I/O - Micro870

Name	Logical Value	Physical Value	Initial Value	Lock	Data Type
in	5	N/A		<input type="checkbox"/>	DINT
maximum	10	N/A		<input type="checkbox"/>	DINT
minimum	2	N/A		<input type="checkbox"/>	DINT
output	5	N/A		<input checked="" type="checkbox"/>	DINT

Close

Variable Monitoring

User Global Variables - Micro870 | Local Variables - RA\_LIMIT\_LD | System Variables - Micro870 | I/O - Micro870

Name	Logical Value	Physical Value	Initial Value	Lock	Data Type
in	1	N/A		<input type="checkbox"/>	DINT
maximum	10	N/A		<input type="checkbox"/>	DINT
minimum	2	N/A		<input type="checkbox"/>	DINT
output	2	N/A		<input checked="" type="checkbox"/>	DINT

Close

Variable Monitoring

User Global Variables - Micro870 | Local Variables - RA\_LIMIT\_LD | System Variables - Micro870 | I/O - Micro870

Name	Logical Value	Physical Value	Initial Value	Lock	Data Type
in	11	N/A		<input type="checkbox"/>	DINT
maximum	10	N/A		<input type="checkbox"/>	DINT
minimum	2	N/A		<input type="checkbox"/>	DINT
output	10	N/A		<input checked="" type="checkbox"/>	DINT

Close



## Program control instruction

Use the program control instruction to control instructions simultaneously from a user program and from an operator interface device.

Instruction	Description
<a href="#">AFI on page 525</a>	Disables a rung.
<a href="#">NOP on page 525</a>	Functions as a placeholder.
<a href="#">SUS on page 525</a>	Suspends the execution of the <M800 controller>.

### AFI (Always False)

Use the AFI instruction at the beginning of a rung to temporarily disable the rung when debugging without having to delete the rung from the program. Output of this instruction is always FALSE.

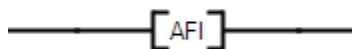

Language supported: Ladder Diagram.

This instruction applies to the Micro820, Micro830, Micro850, Micro870 controllers and Micro800 Simulator.

### NOP (No Operation)

The NOP instruction functions as a placeholder. You can place the NOP instruction anywhere on a rung.

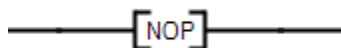

Language supported: Ladder Diagram.

This instruction applies to the Micro820, Micro830, Micro850, Micro870 controllers and Micro800 Simulator.

### SUS (suspend)

Suspends the execution of the <M800 controller>. The controller remains in RUN mode but execution is suspended indefinitely. Suspend catches User Program errors and aids in User Program monitoring. Place the SUS instruction in User Program sections where you want to trap unusual conditions. In suspend mode, RUN LED is set to OFF to indicate the program scan is Idle.

Languages supported: Function Block Diagram, Ladder Diagram, Structured Text.

This instruction applies to the Micro810, Micro820, Micro830, Micro850, Micro870 controllers and Micro800 Simulator.



Use this table to help determine the parameter values for this instruction.

Parameter	Parameter type	Data type	Description
Enable	Input	BOOL	Instruction block enable. TRUE - execute function. FALSE - do not execute function.
SusID	Input	UINT	Suspension ID.
ENO	Output	BOOL	Enable out. Applies only to Ladder Diagram programs.

### SUS Function Block Diagram example

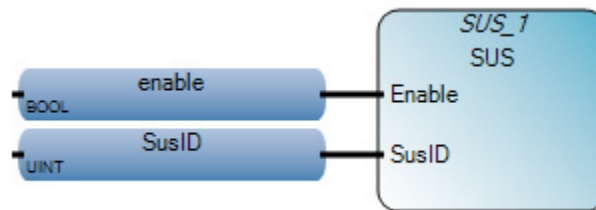

### SUS Ladder Diagram example

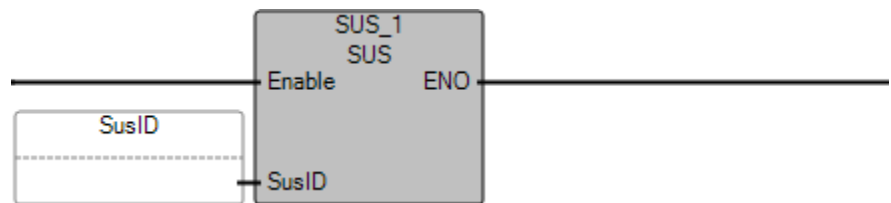

### SUS Structured Text example

```
SUS_1 (
void SUS_1(BOOL Enable, UINT SusID)
Type : SUS, Suspend the execution of the application.

1 | SusID := 1;
2 | SUS_1(enable, SusID);
```

## Results

The screenshot shows a 'Variable Monitoring' window with a table of variables. The table has columns for Name, Logical Value, Physical Value, Initial Value, Lock, and Data Type. The variables listed are SUS\_1, enable, and SUSID.

Name	Logical Value	Physical Value	Initial Value	Lock	Data Type
SUS_1	...	...	...	<input type="checkbox"/>	SUS
enable	<input checked="" type="checkbox"/>	N/A		<input type="checkbox"/>	BOOL
SUSID	1	N/A		<input type="checkbox"/>	UINT

The window also includes tabs for 'User Global Variables - Micro850', 'Local Variables - Prog2', 'System Variables - Micro850', and 'I/O - Micro850'. A 'Close' button is located at the bottom right.





## Proportional Integral Derivative (PID) instruction

Use the Proportional-Integral-Derivative (PID) instructions to control the process more accurately using PID functionality.

Instruction	Description
<a href="#">IPIDCONTROLLER</a> on <a href="#">page 529</a>	Configure and control the inputs and outputs used for the Proportional Integral Derivative (PID) logic.
<a href="#">PID</a> on <a href="#">page 551</a>	Configure and control the outputs that control physical properties such as temperature, pressure, liquid level, or flow rate using process loops.

### What is Proportional Integral Derivative (PID) control?

Proportional-Integral-Derivative (PID) control allows the process control to accurately maintain the setpoint by adjusting the control outputs. A PID function block combines all of the necessary logic to perform proportional/integral/derivative (PID) control.

### IPIDCONTROLLER (proportional-integral-derivative controller)

Configure and control the inputs and outputs used for proportional-integral-derivative (PID) logic. PID logic is used to control physical properties such as temperature, pressure, liquid, level, or flow rate by using process loops that calculate an error value as the difference between a desired setpoint and a measured process variable. The controller attempts to minimize the error over time by adjustment of a control variable. The calculation includes proportional (P), integral (I), and derivative(D) terms, which are used as follows:

- P - present values of the error.
  - I - past values of the error.
  - D - possible future values of the error, based on its current rate of change.
- which controls physical properties such as temperature, pressure, liquid level, or flow rate using process loops.

Languages supported: Function Block Diagram, Ladder Diagram, Structured Text.

This instruction applies to the Micro810, Micro820, Micro830, Micro850, Micro870 controllers and Micro800 Simulator.

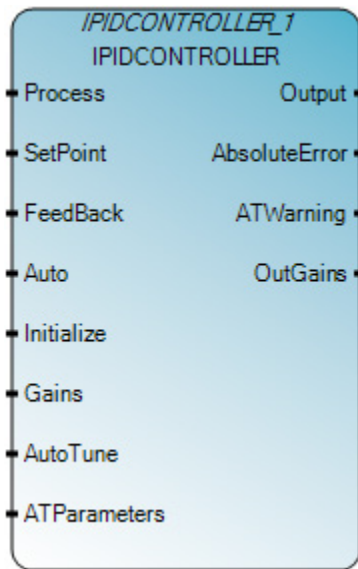

Use this table to help determine the parameter values for this instruction.

Parameter	Parameter type	Data type	Description
EN	Input	BOOL	When TRUE, enables the instruction block. TRUE - execute the PID calculation. FALSE - the instruction block is idle. Applies to Ladder Diagram programs.
Process	Input	REAL	Process value, which is the value measured from the process output.
SetPoint	Input	REAL	Set point.
FeedBack	Input	REAL	Feedback signal, which is the value of the control variable applied to the process. For example, the feedback can be IPIDCONTROLLER output.
Auto	Input	BOOL	The operation mode of the PID controller: <ul style="list-style-type: none"> <li>• TRUE - controller runs in normal mode.</li> <li>• FALSE - controller causes reset R to track (F-GE).</li> </ul>
Initialize	Input	BOOL	A change in value (TRUE to FALSE or FALSE to TRUE) causes the controller to eliminate any proportional gain during that cycle. Also initializes AutoTune sequences.
Gains	Input	GAIN_PID	Gains PID for IPIDController. Use the <a href="#">GAIN_PID data type</a> on <a href="#">page 533</a> to define the parameters for the Gains input.
AutoTune	Input	BOOL	TRUE - When AutoTune is TRUE and Auto and Initialize are FALSE, the AutoTune sequence is started. FALSE - Do not start Autotune.
ATParameters	Input	AT_Param	Auto Tune Parameters. Use the <a href="#">AT_Param data type</a> on <a href="#">page 534</a> to define the parameters for the ATParameters input.
Output	Output	REAL	Output value from the controller.
AbsoluteError	Output	REAL	Absolute error (Process - SetPoint) from the controller.

Parameter	Parameter type	Data type	Description
ATWarnings	Output	DINT	(ATWarning) Warning for the Auto Tune sequence. Possible values are: <ul style="list-style-type: none"> <li>• 0 - no auto tune done.</li> <li>• 1 - in auto tune mode.</li> <li>• 2 - auto tune done.</li> <li>• -1 - ERROR 1 input automatically set to TRUE, no auto tune possible.</li> <li>• -2 - ERROR 2 auto tune error, ATDynaSet expired.</li> </ul>
OutGains	Output	GAIN_PID	Gains calculated after AutoTune sequences. Use the GAIN_PID data type to define the OutGains output.
ENO	Output	BOOL	Enable output. Applies to Ladder Diagram programs.

### IPIDCONTROLLER Function Block Diagram examples

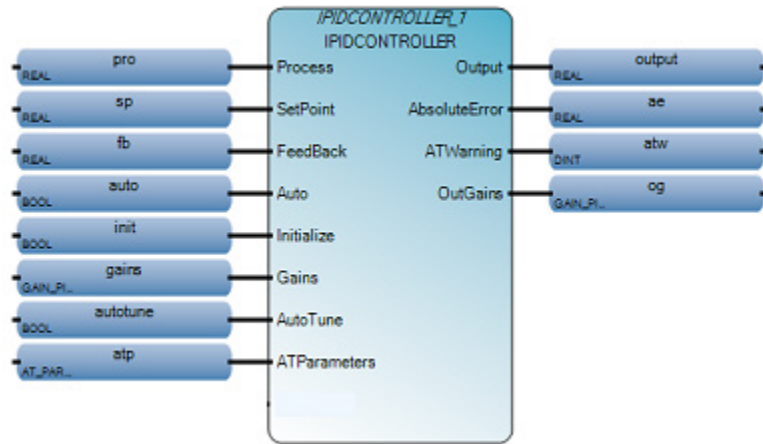

### IPIDCONTROLLER Ladder Diagram example

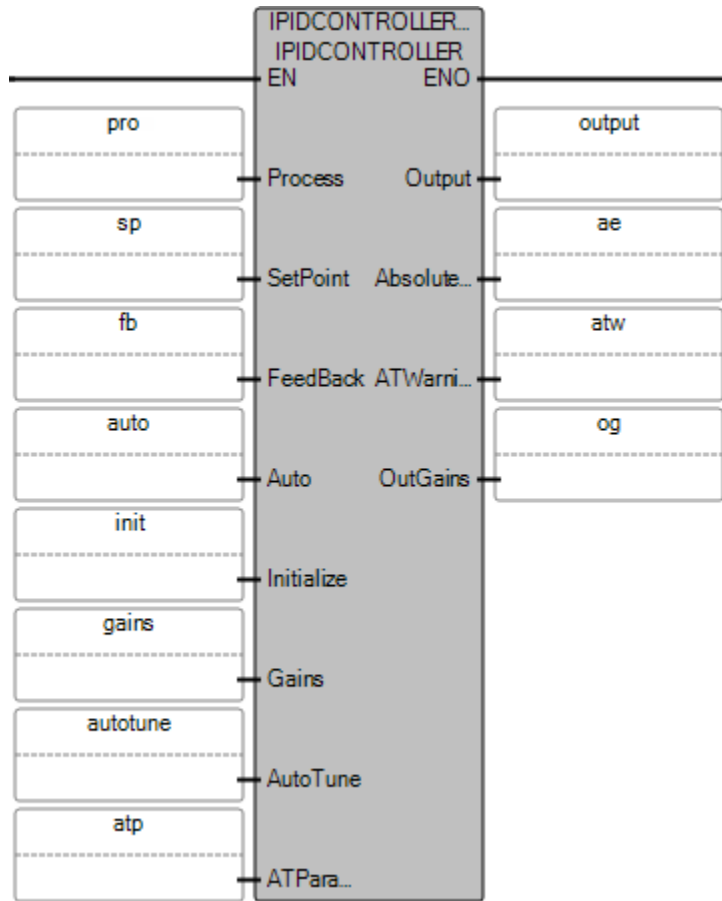

### IPIDCONTROLLER Structured Text example

```

IPIDCONTROLLER_1
void IPIDCONTROLLER_1(REAL Process, REAL SetPoint, REAL FeedBack, BOOL Auto, BOOL Initialize, GAIN_PID Gains, BOOL AutoTune, AT_PARAM ATParameters)
Type: IPIDCONTROLLER, Proportional Integral Derivative.

1  IPIDCONTROLLER_1(pro, sp, fb, auto, init, gains, autotune, atp, em);
2  output := IPIDCONTROLLER_1.Output;
3  ae := IPIDCONTROLLER_1.AbsoluteError;
4  atw := IPIDCONTROLLER_1.ATWarning;
5  og := IPIDCONTROLLER_1.OutGains;

(* ST equivalence: IPIDController1 is an instance of
IPIDController block *)

IPIDController1(Proc,
                SP,
                FBK,
                Auto,
                Init,
                G_In,
                A_Tune,
                A_TunePar,
                Err );

Out_process := IPIDController1.Output ;
A_Tune_Warn := IPIDController1.ATWarning ;
Gain_Out := IPIDController1.OutGains ;
    
```

## Results

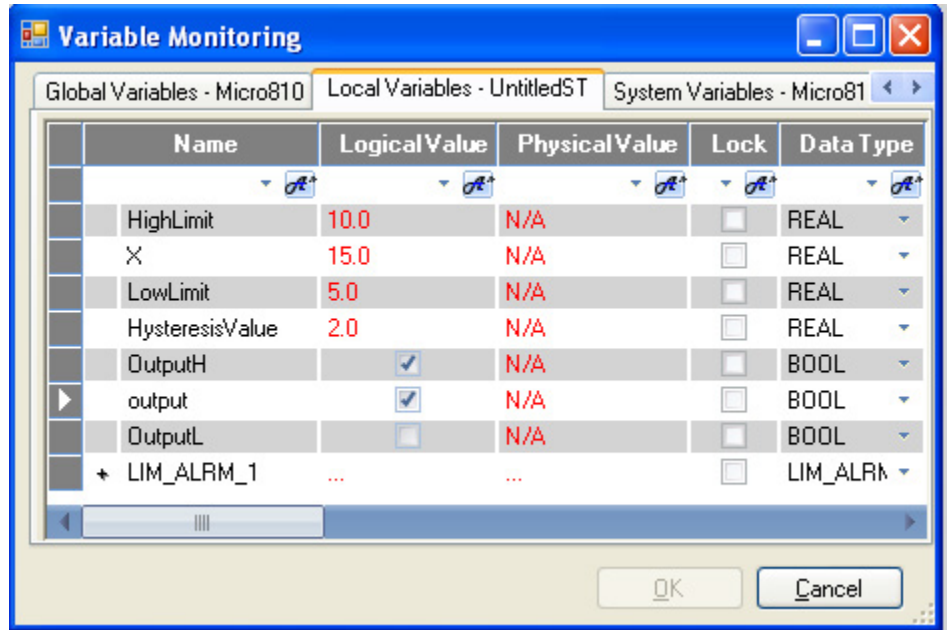

## GAIN\_PID data type

The following table describes the GAIN\_PID data type for the [IPIDCONTROLLER](#) on [page 529](#) instruction.

Parameter	Data type	Description
DirectActing	BOOL	<p>The type of acting:</p> <ul style="list-style-type: none"> <li>• TRUE - direct acting, output moves same direction as error. That is, the actual process value is greater than the SetPoint and the appropriate controller action is to increase the output For example: Chilling.</li> <li>• FALSE - reverse acting, output moves opposite direction as error. That is, the actual process value is greater than the SetPoint and the appropriate controller action is to decrease the output For example: Heating.</li> </ul>
ProportionalGain	REAL	<p>Proportional gain for PID (<math>\geq 0.0001</math>).                      When ProportionalGain is (<math>&lt; 0.0001</math>) then ProportionalGain = 0.0001</p> <p><b>Proportional gain for PID (P_Gain)</b></p> <p>A higher proportional gain causes a larger change in the output based upon the difference between the PV (measured process value) and SV (set point value). The higher the gain, the faster the error is decreased, but this may result in instability such as oscillations. The lower the gain, the slower the error is decreased, but the system is more stable and less sensitive to large errors. The P_Gain usually is the most important gain to adjust and the first gain to adjust while tuning.</p>
TimeIntegral	REAL	<p>Time integral value for PID in seconds (<math>\geq 0.0001</math>).                      When TimeIntegral is (<math>&lt; 0.0001</math>) then TimeIntegral = 0.0001</p> <p><b>Time integral value for PID</b></p> <p>A smaller integral time constant causes a faster change in the output based upon the difference between the PV (measured process value) and SV (set point value) integrated over this time. A smaller integral time constant decreases the steady state error (error when SV is not being changed) but increases the chances of instability such as oscillations. A larger integral time constant slows down the response of the system and make it more stable, but PV approaches the SV at a slower rate.</p>

Parameter	Data type	Description
TimeDerivative	REAL	<p>Time derivative value for PID in seconds (&gt; 0.0).                      When TimeDerivative is (&lt;= 0.0) then TimeDerivative = 0.0                      When TimeDerivative = 0, IPID acts as PI.</p> <p><b>Time derivative value for PID (Td)</b></p> <p>A smaller derivative time constant causes a faster change in the output based upon the rate of change of the difference between PV (measured process value) and SV (set point value). A smaller derivative time constant makes a system more responsive to sudden changes in error (SV is changed) but increases the chances of instability such as oscillations. A larger time constant makes a system less responsive to sudden changes in error and the system is less susceptible to noise and step changes in PV. TimeDerivative (Td) is related to the derivative gain but allows the derivative contribution to PID to be tuned using time so the sample time must be taken into consideration.</p>
DerivativeGain	REAL	<p>Derivative gain for PID (&gt; 0.0).                      When DerivativeGain is (&lt; 0.0) then DerivativeGain = 0.1</p> <p><b>Derivative gain for PID (D_Gain)</b></p> <p>A higher derivative gain causes a larger change in the output based upon the rate of change of the difference between the PV (measured process value) and SV (set point value). A higher gain makes a system more responsive to sudden changes in error but increases the chances of instability such as oscillations. A lower gain makes a system less responsive to sudden changes in error and makes the system less susceptible to noise and step changes in the PV.</p>

## AT\_Param data type

The following table describes the AT\_Param data type parameters.

Parameter	Data type	Description
Load	REAL	Load parameter for auto tuning. This is the output value when starting AutoTune.
Deviation	REAL	Deviation for auto tuning. This is the standard deviation used to evaluate the noise band needed for AutoTune.
Step	REAL	Step value for AutoTune. Must be greater than noise band and less than 1/2 Load.
ATDynamSet	REAL	Waiting time in seconds before abandoning auto tune.
ATReset	BOOL	<p>The indication of whether the output value is reset to zero after an AutoTune sequence:</p> <ul style="list-style-type: none"> <li>• TRUE - resets output to zero.</li> <li>• FALSE - leaves output at Load value.</li> </ul>

## How the IPIDController function block implements PID control

The IPIDController function block, available in the Connected Components Workbench instruction set, is based on PID control theory and combines all of the necessary logic to perform analog input channel processing and proportional integral-derivative (PID) control. In the HMI, the IPID faceplate is available for use with the IPIDController function block.

### IPIDController function block description

The IPIDController function block uses the following function block components:

- A: Acting (+/- 1)
- PG: Proportional Gain
- DG: Derivative Filter Gain

- td:  $\tilde{a}D$
- ti:  $\tilde{a}I$

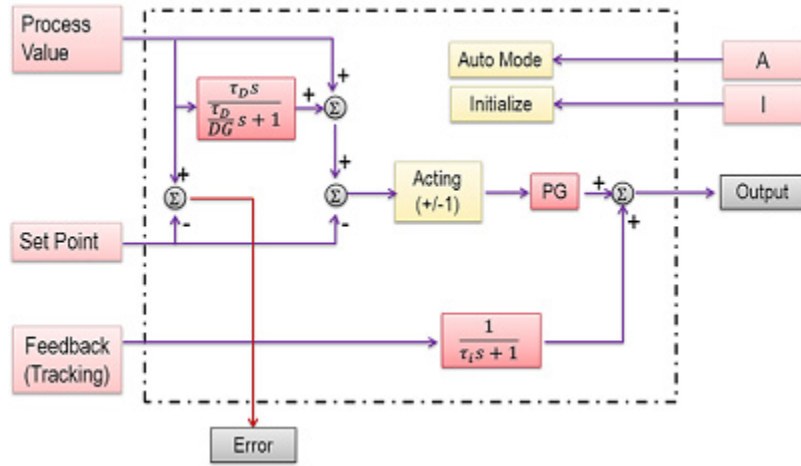

### Preventing integral windup

If the difference between the setpoint value and the process value is great, the output value increases significantly, and during the time it takes to decrease, the process is not in control. The IPIDController function block interactively tracks feedback and prevents integral windup. When the output is saturated, the integral term in the controller is recomputed so that its new value provides an output at the saturation limit.

### IPIDController function block operation

When **Input Auto** is **TRUE**, the IPIDController runs in normal auto mode.

When **Input Auto** is **FALSE**, it causes reset R to track (F-GE) forcing the IPIDController Output to track the Feedback within the IPIDController limits at which time the controller switches back to auto without incrementing the Output.

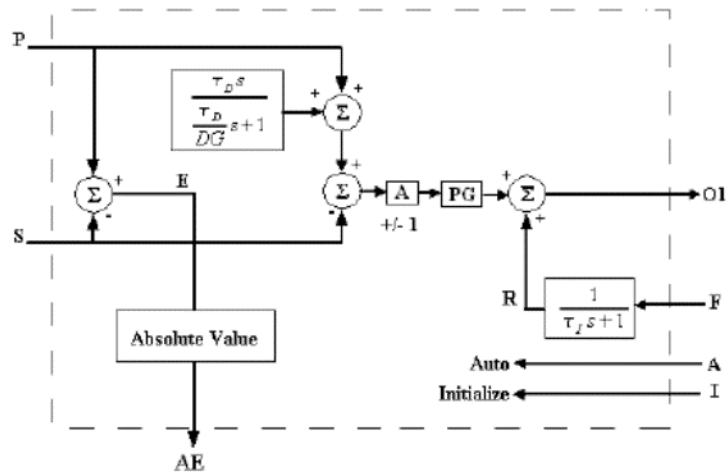

For Input Initialize, changing from FALSE to TRUE or TRUE to FALSE when AutoTune is FALSE causes the IPIDController to eliminate any proportional

gain action during that cycle (for example, Initialize). Use this process to prevent bumping the Output when changes are made to the SetPoint using a switch function block.

### To run an AutoTune sequence:

To run an AutoTune sequence, the input ATParameters must be completed. The Input Gain and DirectActing parameters must be set according to the process and DerivativeGain set, (typically 0.1). The AutoTune sequence is started with the following sequence:

1. Set the input Initialize to TRUE.
2. Set the input Autotune to TRUE.
3. Change the input Initialize to FALSE.
4. Wait until the output ATWarning changes to 2.
5. Transfer the values for output OutGains to input Gains.

To finalize the tuning, some fine tuning may be needed depending on the processes and needs. When setting TimeDerivative to 0.0, the IPIDController forces DerivativeGain to 1.0 then works as a PI controller.

This section provides specific details and examples for using the proportional integral derivative instruction, including the following:

## Use the Proportional Integral Derivative instruction

### Example: How to create a feedback loop for the manipulated value

Adding a feedback loop for the manipulated value prevents excessive overshooting by providing a minimum and maximum value for the MV.

### Temperature feedback loop example

At the beginning of the temperature control process, the difference between the process value (PV) and the setpoint value (SP) is large, as shown in the following graph. In this example of a temperature feedback loop, the PV starts at 0 degrees Celsius and moves towards the SP value of 40 degrees Celsius. Notice also that the fluctuation between the high and low manipulated value (MV) decreases and stabilizes with time. The behavior of the MV depends on the values used in each of the P, I, and D parameters.



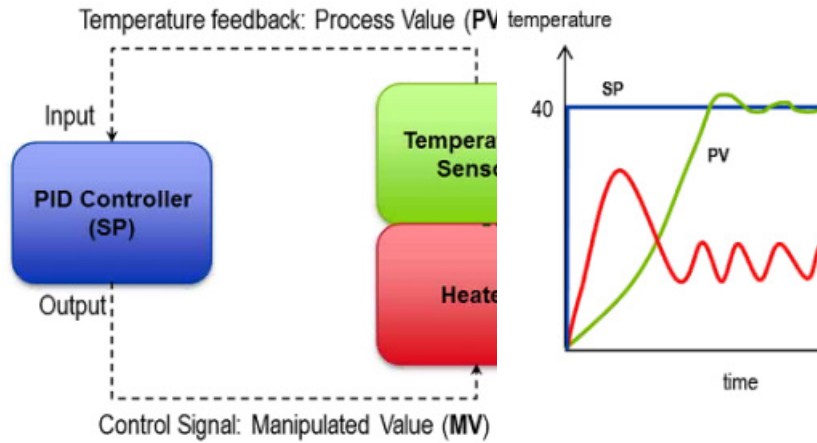

### IPIDController with a feedback loop

The following function block diagram includes a feedback loop for the manipulated value that prevents excessive overshooting by providing a minimum and maximum value for the MV.

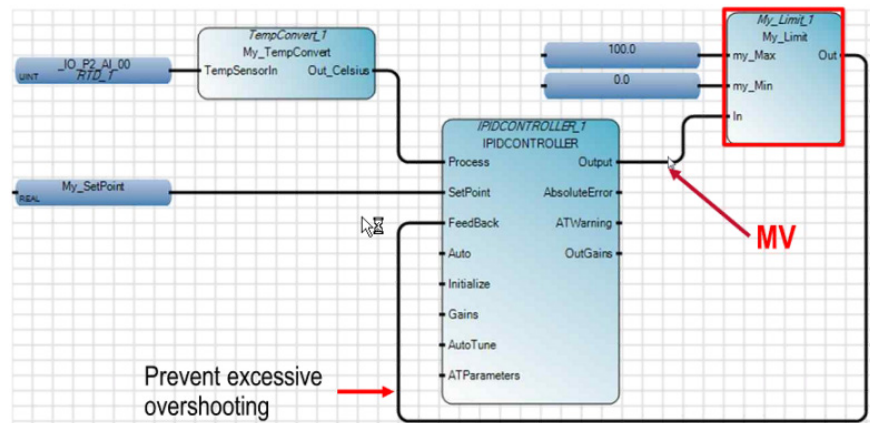

### Example: How to implement auto-tuning in a IPIDController function block

Use AutoTune parameter of the IPIDController function block to implement auto-tuning in the control program.

### Auto-tuning requirements and recommendations

Following is a summary of requirements and recommendations for implementing successful auto-tuning.

- Autotuning must cause the output of the control loop to oscillate, which means the IPIDController must be called frequently enough to adequately sample the oscillation.

- The IPIDController instruction block must be executed at a relatively constant time interval.
- Configure the scan time of the program to be than half of the oscillation period.
- Consider using a Structured Text Interrupt (STI) instruction block to control the IPIDController instruction block.

### Example: How to add a UDFB to a PID program

Add UDFBs outside the main program to perform specialized functions such as converting units or transferring values.

#### Transfer the auto-tune gain value

This UDFB transfers the Autotune gain value to My\_GainTransfer so it can be used by the controller.

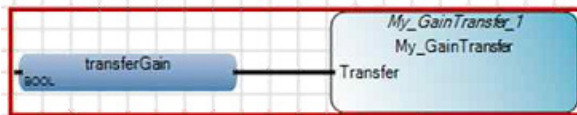

#### Convert a manipulated value to a digital output

This UDFB converts a manipulated value (MV) to a digital output (DO) so it can be used to control a digital input n(DI).

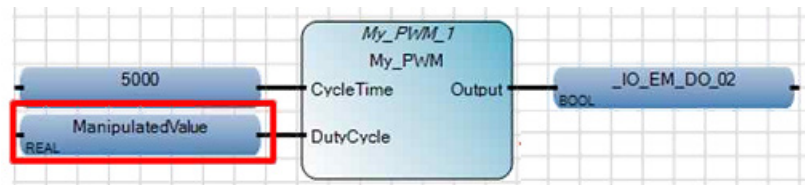

#### Convert a manipulated value to an analog output

This UDFB converts a manipulated value (MV) to an analog output (AO) so it can be used to control an analog input (AI).

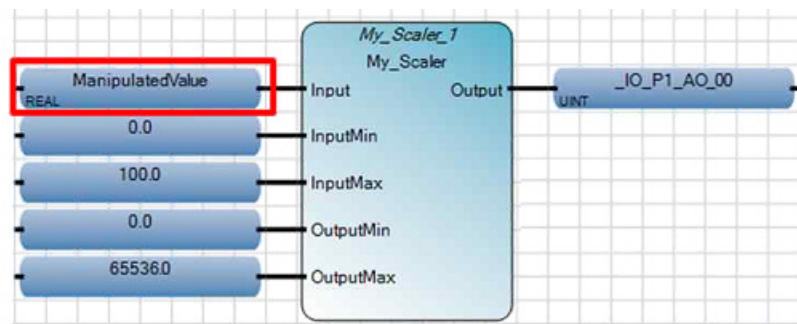

## Use auto-tune with the IPIDController function block

Use the AutoTune parameter of the IPIDController function block to implement auto-tuning in the control program.

### Auto-tuning requirements and recommendations

Following is a summary of requirements and recommendations for implementing successful auto-tuning.

- Autotuning must cause the output of the control loop to oscillate, which means the IPIDController must be called frequently enough to adequately sample the oscillation.
- The IPIDController instruction block must be executed at a relatively constant time interval.
- Configure the scan time of the program to be than half of the oscillation period.
- Consider using a Selectable Timed Interrupt (STI) instruction block to control the IPIDController instruction block.

## Auto-tune in first and second order systems

Use auto-tune in first order system, which uses a single element, or in a second order system, which uses two independent elements.

A first order system uses a single independent energy storage element.

Examples include:

- Cooling of a fluid tank, with heat energy as the storage unit.
- Flow of fluid from a tank, with potential energy as the storage unit.
- A motor with constant torque driving a disk flywheel, with rotational kinetic energy as the storage unit.
- An electric RC lead network, with capacitive storage energy as the storage unit.

In a first order system, the function may be written in a standard form such as  $f(t) = \tau \, dy/dt + y(t)$

Where:

Variable	Description	Example: Cooling of a fluid tank using heat energy as the storage element
t	System time constant	Is equal to RC Where R = Thermal resistance of the walls of the tank C = Thermal capacitance of the fluid
f	Forcing function	Is the Ambient temperature
y	System state variable	Is the Fluid temperature

A second order system uses two independent energy storage elements that exchange stored energy. Examples include:

- A motor driving a disk flywheel with the motor coupled to the flywheel via a shaft with torsional stiffness; Rotational kinetic energy and torsion spring energy are the storage units.

- An electric circuit composed of a current source driving a series LR (inductor and resistor) with a shunt C (capacitor); Inductive energy and capacitive energy are the storage units.



Motor driven systems and heating systems can typically be modeled by the LR and the C electric circuit.

## Configure auto-tuning

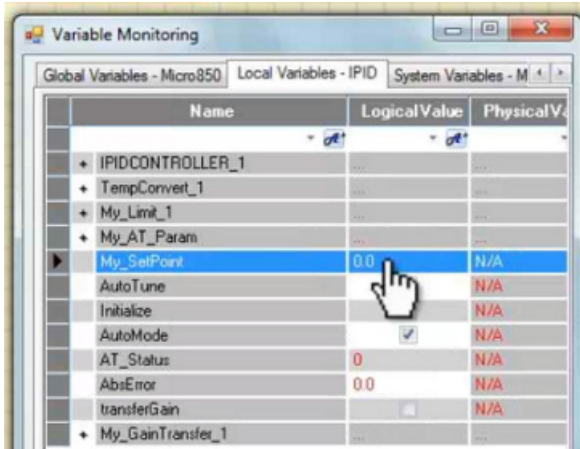
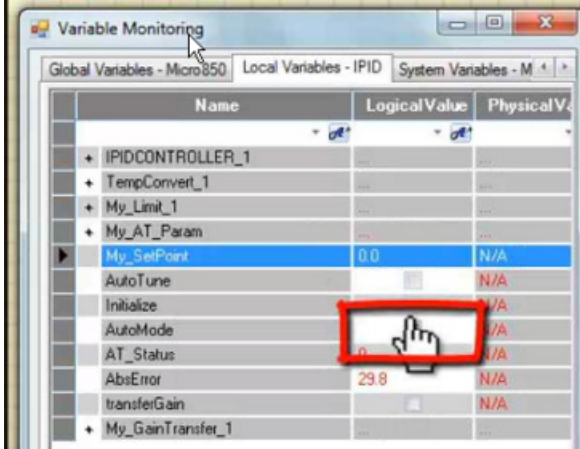
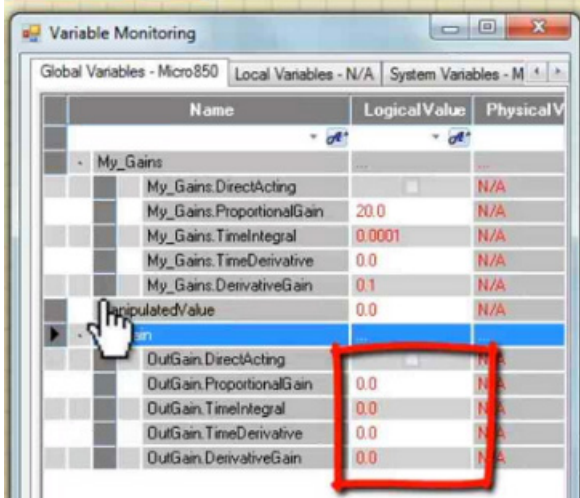
Use these general steps when [implementing auto-tuning using the IPIDController function](#) on [page 539](#).

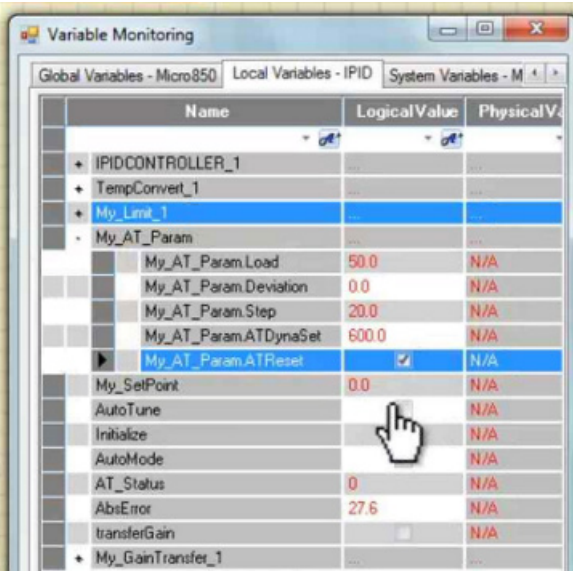
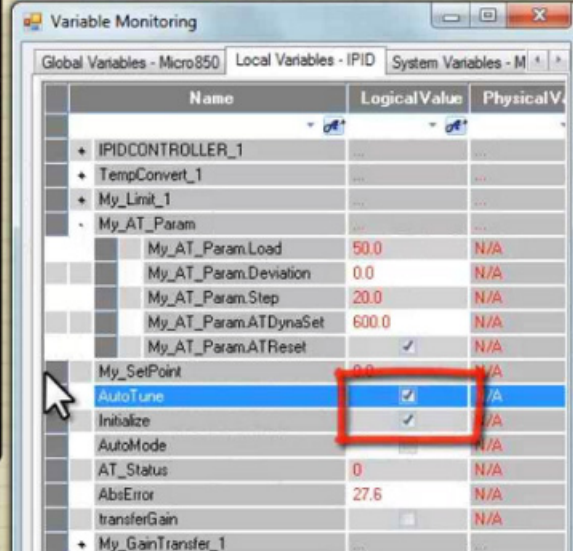
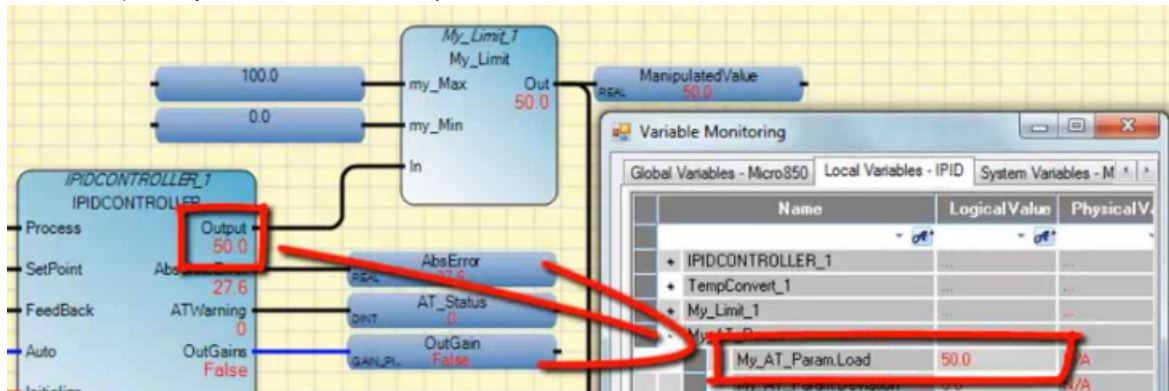
No.	Step	Example
1	Reset setpoint to zero.	 <p>The screenshot shows the 'Variable Monitoring' window with the 'Local Variables - IPID' tab selected. The table lists various variables. 'My_SetPoint' is highlighted in blue, and its 'LogicalValue' is 0.0. A mouse cursor is pointing at the value.</p>
2	Switch Auto mode to False	 <p>The screenshot shows the 'Variable Monitoring' window. The 'AutoMode' variable is highlighted in blue, and its 'LogicalValue' is 0. A red box highlights the checkbox next to the value, which is currently unchecked. A mouse cursor is pointing at the checkbox.</p>
3	Set Gains parameters.	 <p>The screenshot shows the 'Variable Monitoring' window with the 'Local Variables - N/A' tab selected. The 'My_Gains' folder is expanded, showing several gain parameters. The 'OutGain.ProportionalGain' variable is highlighted in blue, and its 'LogicalValue' is 0.0. A red box highlights the value.</p>

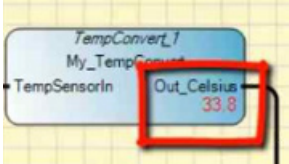
<p><b>No.</b> 4</p>	<p><b>Step</b> Set Auto-Tune parameters.</p>	<p><b>Example</b> Set auto-tune parameters including an initial load value, step change for the output, an estimated time to complete the auto tuning, and the auto-tune reset.</p>  <p>The screenshot shows the 'Variable Monitoring' window with the 'Local Variables - IPID' tab selected. The table below represents the data shown in the window:</p> <table border="1"> <thead> <tr> <th>Name</th> <th>Logical Value</th> <th>Physical Value</th> </tr> </thead> <tbody> <tr><td>IPIDCONTROLLER_1</td><td>...</td><td>...</td></tr> <tr><td>TempConvert_1</td><td>...</td><td>...</td></tr> <tr><td>My_Limit_1</td><td>...</td><td>...</td></tr> <tr><td>My_AT_Param</td><td>...</td><td>...</td></tr> <tr><td>  My_AT_Param.Load</td><td>50.0</td><td>N/A</td></tr> <tr><td>  My_AT_Param.Deviation</td><td>0.0</td><td>N/A</td></tr> <tr><td>  My_AT_Param.Step</td><td>20.0</td><td>N/A</td></tr> <tr><td>  My_AT_Param.ATDynaSet</td><td>600.0</td><td>N/A</td></tr> <tr><td>  My_AT_Param.ATReset</td><td><input checked="" type="checkbox"/></td><td>N/A</td></tr> <tr><td>My_SetPoint</td><td>0.0</td><td>N/A</td></tr> <tr><td>AutoTune</td><td><input type="checkbox"/></td><td>N/A</td></tr> <tr><td>Initialize</td><td><input type="checkbox"/></td><td>N/A</td></tr> <tr><td>AutoMode</td><td><input type="checkbox"/></td><td>N/A</td></tr> <tr><td>AT_Status</td><td>0</td><td>N/A</td></tr> <tr><td>AbsError</td><td>27.6</td><td>N/A</td></tr> <tr><td>transferGain</td><td><input type="checkbox"/></td><td>N/A</td></tr> <tr><td>My_GainTransfer_1</td><td>...</td><td>...</td></tr> </tbody> </table>	Name	Logical Value	Physical Value	IPIDCONTROLLER_1	...	...	TempConvert_1	...	...	My_Limit_1	...	...	My_AT_Param	...	...	My_AT_Param.Load	50.0	N/A	My_AT_Param.Deviation	0.0	N/A	My_AT_Param.Step	20.0	N/A	My_AT_Param.ATDynaSet	600.0	N/A	My_AT_Param.ATReset	<input checked="" type="checkbox"/>	N/A	My_SetPoint	0.0	N/A	AutoTune	<input type="checkbox"/>	N/A	Initialize	<input type="checkbox"/>	N/A	AutoMode	<input type="checkbox"/>	N/A	AT_Status	0	N/A	AbsError	27.6	N/A	transferGain	<input type="checkbox"/>	N/A	My_GainTransfer_1	...	...
Name	Logical Value	Physical Value																																																						
IPIDCONTROLLER_1	...	...																																																						
TempConvert_1	...	...																																																						
My_Limit_1	...	...																																																						
My_AT_Param	...	...																																																						
My_AT_Param.Load	50.0	N/A																																																						
My_AT_Param.Deviation	0.0	N/A																																																						
My_AT_Param.Step	20.0	N/A																																																						
My_AT_Param.ATDynaSet	600.0	N/A																																																						
My_AT_Param.ATReset	<input checked="" type="checkbox"/>	N/A																																																						
My_SetPoint	0.0	N/A																																																						
AutoTune	<input type="checkbox"/>	N/A																																																						
Initialize	<input type="checkbox"/>	N/A																																																						
AutoMode	<input type="checkbox"/>	N/A																																																						
AT_Status	0	N/A																																																						
AbsError	27.6	N/A																																																						
transferGain	<input type="checkbox"/>	N/A																																																						
My_GainTransfer_1	...	...																																																						
<p><b>No.</b> 5</p>	<p><b>Step</b> Set Initialize and AutoTune to True.</p>	 <p>The screenshot shows the 'Variable Monitoring' window with the 'Local Variables - IPID' tab selected. The table below represents the data shown in the window:</p> <table border="1"> <thead> <tr> <th>Name</th> <th>Logical Value</th> <th>Physical Value</th> </tr> </thead> <tbody> <tr><td>IPIDCONTROLLER_1</td><td>...</td><td>...</td></tr> <tr><td>TempConvert_1</td><td>...</td><td>...</td></tr> <tr><td>My_Limit_1</td><td>...</td><td>...</td></tr> <tr><td>My_AT_Param</td><td>...</td><td>...</td></tr> <tr><td>  My_AT_Param.Load</td><td>50.0</td><td>N/A</td></tr> <tr><td>  My_AT_Param.Deviation</td><td>0.0</td><td>N/A</td></tr> <tr><td>  My_AT_Param.Step</td><td>20.0</td><td>N/A</td></tr> <tr><td>  My_AT_Param.ATDynaSet</td><td>600.0</td><td>N/A</td></tr> <tr><td>  My_AT_Param.ATReset</td><td><input checked="" type="checkbox"/></td><td>N/A</td></tr> <tr><td>My_SetPoint</td><td>0.0</td><td>N/A</td></tr> <tr><td>AutoTune</td><td><input checked="" type="checkbox"/></td><td>N/A</td></tr> <tr><td>Initialize</td><td><input checked="" type="checkbox"/></td><td>N/A</td></tr> <tr><td>AutoMode</td><td><input type="checkbox"/></td><td>N/A</td></tr> <tr><td>AT_Status</td><td>0</td><td>N/A</td></tr> <tr><td>AbsError</td><td>27.6</td><td>N/A</td></tr> <tr><td>transferGain</td><td><input type="checkbox"/></td><td>N/A</td></tr> <tr><td>My_GainTransfer_1</td><td>...</td><td>...</td></tr> </tbody> </table>	Name	Logical Value	Physical Value	IPIDCONTROLLER_1	...	...	TempConvert_1	...	...	My_Limit_1	...	...	My_AT_Param	...	...	My_AT_Param.Load	50.0	N/A	My_AT_Param.Deviation	0.0	N/A	My_AT_Param.Step	20.0	N/A	My_AT_Param.ATDynaSet	600.0	N/A	My_AT_Param.ATReset	<input checked="" type="checkbox"/>	N/A	My_SetPoint	0.0	N/A	AutoTune	<input checked="" type="checkbox"/>	N/A	Initialize	<input checked="" type="checkbox"/>	N/A	AutoMode	<input type="checkbox"/>	N/A	AT_Status	0	N/A	AbsError	27.6	N/A	transferGain	<input type="checkbox"/>	N/A	My_GainTransfer_1	...	...
Name	Logical Value	Physical Value																																																						
IPIDCONTROLLER_1	...	...																																																						
TempConvert_1	...	...																																																						
My_Limit_1	...	...																																																						
My_AT_Param	...	...																																																						
My_AT_Param.Load	50.0	N/A																																																						
My_AT_Param.Deviation	0.0	N/A																																																						
My_AT_Param.Step	20.0	N/A																																																						
My_AT_Param.ATDynaSet	600.0	N/A																																																						
My_AT_Param.ATReset	<input checked="" type="checkbox"/>	N/A																																																						
My_SetPoint	0.0	N/A																																																						
AutoTune	<input checked="" type="checkbox"/>	N/A																																																						
Initialize	<input checked="" type="checkbox"/>	N/A																																																						
AutoMode	<input type="checkbox"/>	N/A																																																						
AT_Status	0	N/A																																																						
AbsError	27.6	N/A																																																						
transferGain	<input type="checkbox"/>	N/A																																																						
My_GainTransfer_1	...	...																																																						
<p><b>No.</b> 6</p>	<p>Notice the Output changes to the value of Load when you set AutoTune to True.</p>  <p>The screenshot shows a ladder logic diagram and a 'Variable Monitoring' window. In the ladder logic, the 'IPIDCONTROLLER_1' block has its 'Output' set to 50.0. This value is connected to the 'In' input of the 'My_Limit_1' block. The 'My_Limit_1' block has 'my_Max' set to 100.0 and 'my_Min' set to 0.0. The 'Out' of 'My_Limit_1' is 50.0, which is connected to the 'Manipulated Value' output. The 'Variable Monitoring' window shows the 'My_AT_Param.Load' variable set to 50.0. Red boxes and arrows highlight the 'Output' of the IPIDCONTROLLER_1 block, the 'Out' of the My_Limit_1 block, and the 'My_AT_Param.Load' variable in the Variable Monitoring window, showing they all have the value 50.0.</p>																																																							

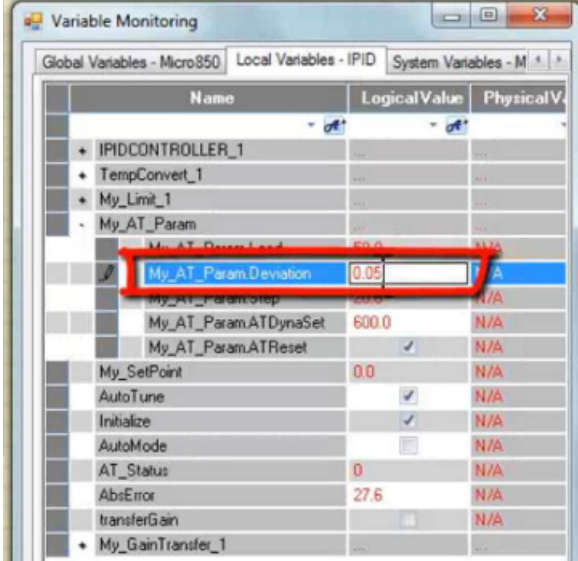
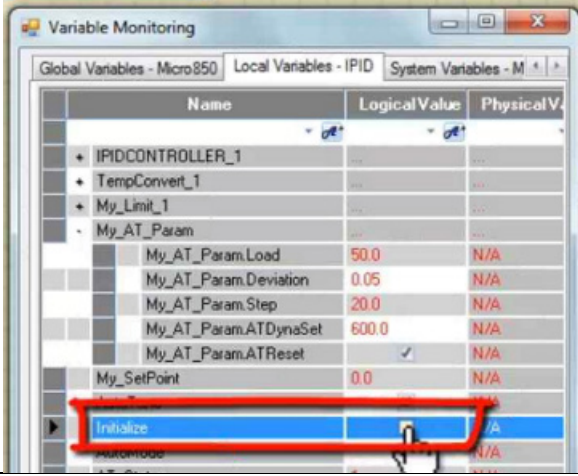
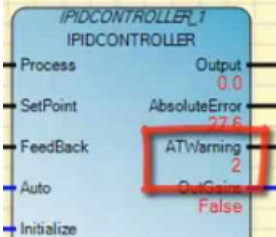
No.	Step	Example																																																						
7	Observe the process value rises quickly until it gets closer to its saturation point.																																																							
8	Observe the stabilization of the process value and its fluctuation.																																																							
9	Set the deviation.	 <table border="1" data-bbox="625 535 1144 1039"> <thead> <tr> <th>Name</th> <th>Logical Value</th> <th>Physical Value</th> </tr> </thead> <tbody> <tr> <td>IPIDCONTROLLER_1</td> <td>...</td> <td>...</td> </tr> <tr> <td>TempConvert_1</td> <td>...</td> <td>...</td> </tr> <tr> <td>My_Limit_1</td> <td>...</td> <td>...</td> </tr> <tr> <td>My_AT_Param</td> <td>...</td> <td>...</td> </tr> <tr> <td>My_AT_Param.Deviation</td> <td>0.05</td> <td>N/A</td> </tr> <tr> <td>My_AT_Param.Load</td> <td>50.0</td> <td>N/A</td> </tr> <tr> <td>My_AT_Param.Step</td> <td>20.0</td> <td>N/A</td> </tr> <tr> <td>My_AT_Param.ATDynaSet</td> <td>600.0</td> <td>N/A</td> </tr> <tr> <td>My_AT_Param.ATRReset</td> <td><input checked="" type="checkbox"/></td> <td>N/A</td> </tr> <tr> <td>My_SetPoint</td> <td>0.0</td> <td>N/A</td> </tr> <tr> <td>AutoTune</td> <td><input checked="" type="checkbox"/></td> <td>N/A</td> </tr> <tr> <td>Initialize</td> <td><input checked="" type="checkbox"/></td> <td>N/A</td> </tr> <tr> <td>AutoMode</td> <td><input type="checkbox"/></td> <td>N/A</td> </tr> <tr> <td>AT_Status</td> <td>0</td> <td>N/A</td> </tr> <tr> <td>AbsError</td> <td>27.6</td> <td>N/A</td> </tr> <tr> <td>transferGain</td> <td><input type="checkbox"/></td> <td>N/A</td> </tr> <tr> <td>My_GainTransfer_1</td> <td>...</td> <td>...</td> </tr> </tbody> </table>	Name	Logical Value	Physical Value	IPIDCONTROLLER_1	...	...	TempConvert_1	...	...	My_Limit_1	...	...	My_AT_Param	...	...	My_AT_Param.Deviation	0.05	N/A	My_AT_Param.Load	50.0	N/A	My_AT_Param.Step	20.0	N/A	My_AT_Param.ATDynaSet	600.0	N/A	My_AT_Param.ATRReset	<input checked="" type="checkbox"/>	N/A	My_SetPoint	0.0	N/A	AutoTune	<input checked="" type="checkbox"/>	N/A	Initialize	<input checked="" type="checkbox"/>	N/A	AutoMode	<input type="checkbox"/>	N/A	AT_Status	0	N/A	AbsError	27.6	N/A	transferGain	<input type="checkbox"/>	N/A	My_GainTransfer_1	...	...
Name	Logical Value	Physical Value																																																						
IPIDCONTROLLER_1	...	...																																																						
TempConvert_1	...	...																																																						
My_Limit_1	...	...																																																						
My_AT_Param	...	...																																																						
My_AT_Param.Deviation	0.05	N/A																																																						
My_AT_Param.Load	50.0	N/A																																																						
My_AT_Param.Step	20.0	N/A																																																						
My_AT_Param.ATDynaSet	600.0	N/A																																																						
My_AT_Param.ATRReset	<input checked="" type="checkbox"/>	N/A																																																						
My_SetPoint	0.0	N/A																																																						
AutoTune	<input checked="" type="checkbox"/>	N/A																																																						
Initialize	<input checked="" type="checkbox"/>	N/A																																																						
AutoMode	<input type="checkbox"/>	N/A																																																						
AT_Status	0	N/A																																																						
AbsError	27.6	N/A																																																						
transferGain	<input type="checkbox"/>	N/A																																																						
My_GainTransfer_1	...	...																																																						
10	Set Initialize to False.	 <table border="1" data-bbox="625 1102 1144 1522"> <thead> <tr> <th>Name</th> <th>Logical Value</th> <th>Physical Value</th> </tr> </thead> <tbody> <tr> <td>IPIDCONTROLLER_1</td> <td>...</td> <td>...</td> </tr> <tr> <td>TempConvert_1</td> <td>...</td> <td>...</td> </tr> <tr> <td>My_Limit_1</td> <td>...</td> <td>...</td> </tr> <tr> <td>My_AT_Param</td> <td>...</td> <td>...</td> </tr> <tr> <td>My_AT_Param.Deviation</td> <td>0.05</td> <td>N/A</td> </tr> <tr> <td>My_AT_Param.Load</td> <td>50.0</td> <td>N/A</td> </tr> <tr> <td>My_AT_Param.Step</td> <td>20.0</td> <td>N/A</td> </tr> <tr> <td>My_AT_Param.ATDynaSet</td> <td>600.0</td> <td>N/A</td> </tr> <tr> <td>My_AT_Param.ATRReset</td> <td><input checked="" type="checkbox"/></td> <td>N/A</td> </tr> <tr> <td>My_SetPoint</td> <td>0.0</td> <td>N/A</td> </tr> <tr> <td>Initialize</td> <td><input type="checkbox"/></td> <td>N/A</td> </tr> <tr> <td>AutoMode</td> <td><input type="checkbox"/></td> <td>N/A</td> </tr> <tr> <td>AT_Status</td> <td>...</td> <td>...</td> </tr> <tr> <td>AbsError</td> <td>...</td> <td>...</td> </tr> <tr> <td>transferGain</td> <td><input type="checkbox"/></td> <td>N/A</td> </tr> <tr> <td>My_GainTransfer_1</td> <td>...</td> <td>...</td> </tr> </tbody> </table>	Name	Logical Value	Physical Value	IPIDCONTROLLER_1	...	...	TempConvert_1	...	...	My_Limit_1	...	...	My_AT_Param	...	...	My_AT_Param.Deviation	0.05	N/A	My_AT_Param.Load	50.0	N/A	My_AT_Param.Step	20.0	N/A	My_AT_Param.ATDynaSet	600.0	N/A	My_AT_Param.ATRReset	<input checked="" type="checkbox"/>	N/A	My_SetPoint	0.0	N/A	Initialize	<input type="checkbox"/>	N/A	AutoMode	<input type="checkbox"/>	N/A	AT_Status	...	...	AbsError	...	...	transferGain	<input type="checkbox"/>	N/A	My_GainTransfer_1	...	...			
Name	Logical Value	Physical Value																																																						
IPIDCONTROLLER_1	...	...																																																						
TempConvert_1	...	...																																																						
My_Limit_1	...	...																																																						
My_AT_Param	...	...																																																						
My_AT_Param.Deviation	0.05	N/A																																																						
My_AT_Param.Load	50.0	N/A																																																						
My_AT_Param.Step	20.0	N/A																																																						
My_AT_Param.ATDynaSet	600.0	N/A																																																						
My_AT_Param.ATRReset	<input checked="" type="checkbox"/>	N/A																																																						
My_SetPoint	0.0	N/A																																																						
Initialize	<input type="checkbox"/>	N/A																																																						
AutoMode	<input type="checkbox"/>	N/A																																																						
AT_Status	...	...																																																						
AbsError	...	...																																																						
transferGain	<input type="checkbox"/>	N/A																																																						
My_GainTransfer_1	...	...																																																						
11	Controller starts auto-tuning. Wait for ATWarning to become 2.																																																							

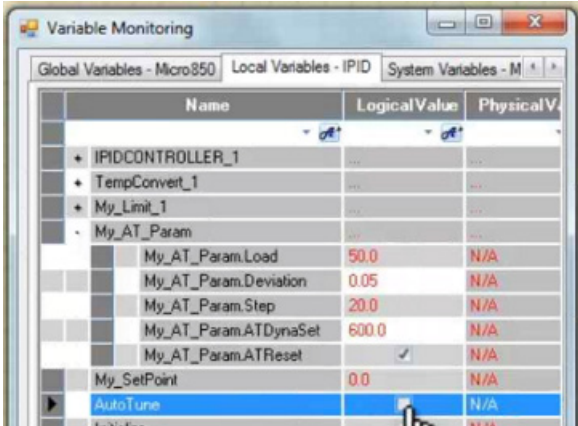
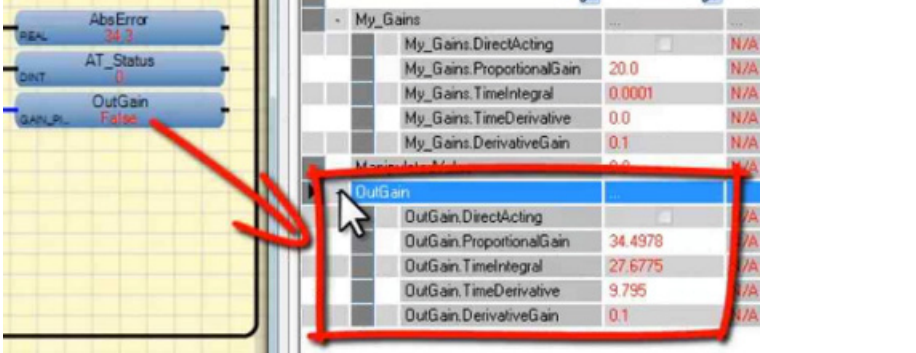
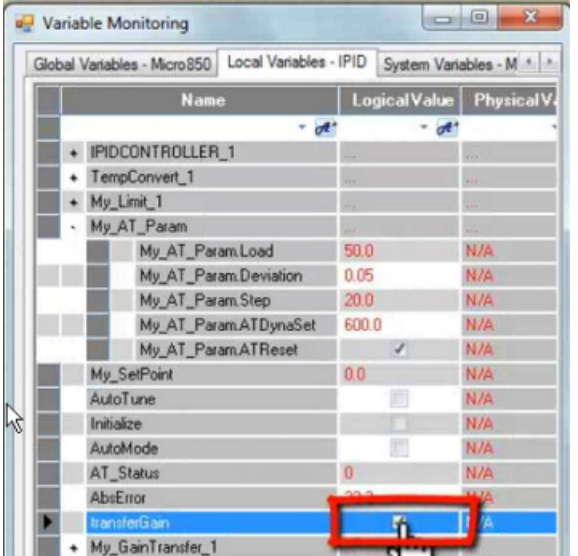
No.	Step	Example
12	Set AutoTune to False.	 <p>The screenshot shows the 'Variable Monitoring' window with the 'System Variables - M' tab selected. The 'AutoTune' parameter is highlighted in blue, and its 'Logical Value' is 'False'.</p>
13	Observe the tuned values appear in OutGains.	 <p>The screenshot shows the 'Variable Monitoring' window with the 'System Variables - M' tab selected. The 'OutGain' parameter is highlighted in blue, and its 'Logical Value' is 'False'. A red box highlights the 'OutGain' parameter and its sub-parameters: 'OutGain.DirectActing', 'OutGain.ProportionalGain' (34.4978), 'OutGain.TimeIntegral' (27.6775), 'OutGain.TimeDerivative' (9.795), and 'OutGain.DerivativeGain' (0.1).</p>
14	Transfer parameter from OutGain to My_Gains.	 <p>The screenshot shows the 'Variable Monitoring' window with the 'System Variables - M' tab selected. The 'transferGain' parameter is highlighted in blue, and its 'Logical Value' is 'N/A'.</p>

**No.** 15  
**Step** Observe the controller is updated with the with the tuned gain parameter.

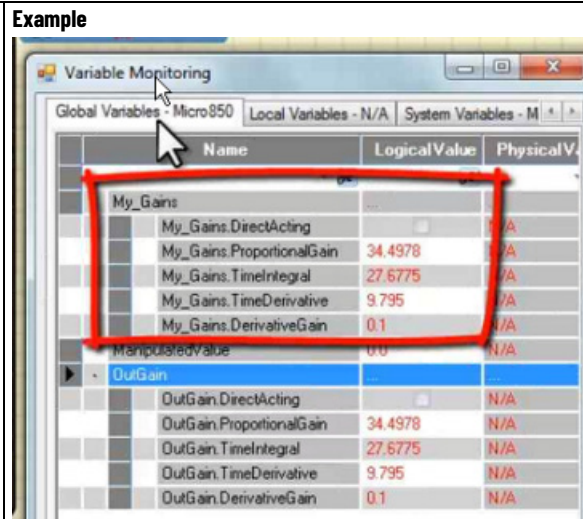

### Use a Selectable Timed Interrupt (STI) with auto-tuning

Although a PID instruction works if it is not controlled by a Selectable Timed Interrupt (STI), using an STI increases the auto-tune success rate because the auto-tune operates on a fixed cycle.

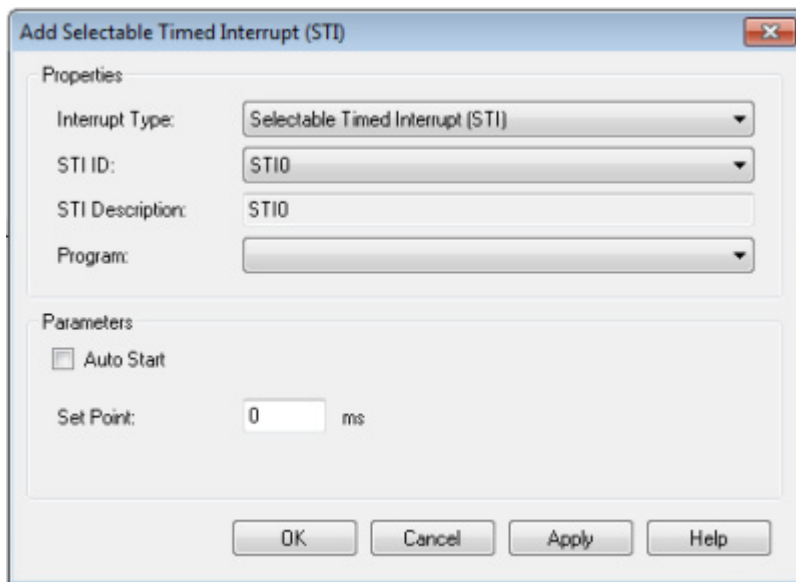

### Example: IPIDController with auto-tune

The following example program shows the variables used to configure the parameters for auto-tuning.

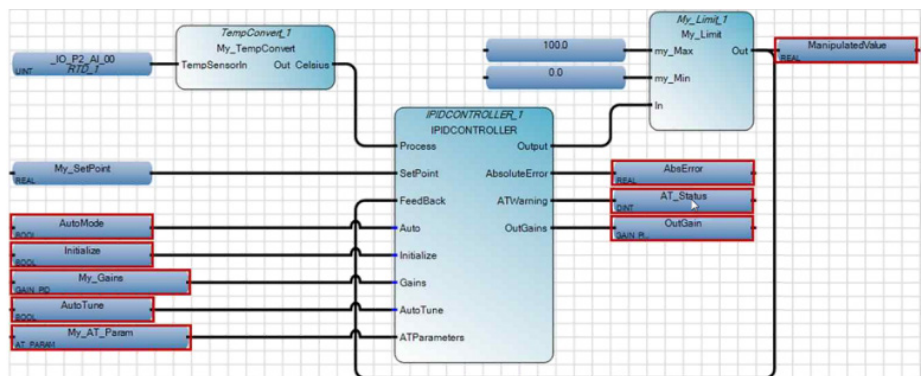



## Auto-tune parameters

The following table describes the variables that are used with each parameter in the example to configure auto-tuning.

<b>Input parameters</b>		
<b>Variable</b>	<b>Parameter</b>	<b>Description</b>
AutoMode	Auto	The operation mode of the PID controller: TRUE - controller runs in normal mode. FALSE - derivative term is ignored forcing the controller output to track the feedback within the controller limits and allowing the controller to switch back to auto without bumping the output.
Initialize	Initialize	Initializes AutoTune sequence. A change in value from TRUE to FALSE or FALSE to TRUE causes the controller to eliminate any proportional gain during the cycle.
My_Gains	Gains	Establishes the Gains PID for IPIDController.
My_Gains.DirectActing	DirectActing	Defines the type of acting for the output. TRUE - direct acting in which the output moves in the same direction as the error. That is, the actual process value is greater than the SetPoint and the appropriate controller action is to increase the output. For example, chilling. FALSE - reverse acting in which the output moves in the opposite direction as the error. That is, the actual process value is greater than the SetPoint and the appropriate controller action is to decrease the output. For example: heating.
My_Gains.ProportionalGain	ProportionalGain	Proportional gain for PID ( $\geq 0.0001$ ).
My_Gains.TimeIntegral	TimeIntegral	Time integral value for PID ( $\geq 0.0001$ ). The tendency for oscillation increases with a decrease in $t_i$ .
My_Gains.TimeDerivative	TimeDerivative	Time derivative value for PID ( $> 0.0$ ). Damping increases with an increase in derivative time, but decreases if the derivative time value is too large.
My_Gains.DerivativeGain	Derivative gain for PID ( $> 0.0$ ).	
AutoTune	When set to TRUE and Auto and Initialize are FALSE, the AutoTune sequence is started.	
<b>ATParameters</b>		
Load	<ul style="list-style-type: none"> <li>Initial output value during auto-tuning.</li> <li>Allows the process value to stabilize at the load</li> </ul>	
Deviation	<ul style="list-style-type: none"> <li>The standard deviation for a series of stabilized process values. For example, if the process value stabilized between 31.4 to 32.0, then the deviation value would be <math>(32.0-31.4)/2 = 0.3</math>.</li> <li>Some process values, such as temperature, take a very long time to stabilize.</li> </ul>	
Step	<ul style="list-style-type: none"> <li>The auto-tune process considers how the process value reacts to the changes in step value and derives the Gain parameters.</li> </ul>	
ATDynaSet	<ul style="list-style-type: none"> <li>Allocated time for the auto-tune to complete. It must be longer than what is required for the auto-tune process.</li> <li>A common value for many systems is 600 seconds but some systems may require more time.</li> </ul>	
ATReset	<ul style="list-style-type: none"> <li>If TRUE, the output will be reset to "0" after auto-tune completes.</li> <li>If FALSE, the output will remain at the load value after auto-tune completes.</li> </ul>	
<b>Output parameters</b>		
<b>Parameter</b>	<b>Description</b>	
AbsoluteError	Absolute error (Process - SetPoint) from the controller.	
ATWarning	Warning for the Auto Tune sequence. Possible values are: <ul style="list-style-type: none"> <li>0 - no auto tune done.</li> <li>1 - in auto tune mode.</li> <li>2 - auto tune done.</li> <li>-1 - ERROR 1 input automatically set to TRUE, no auto tune possible.</li> <li>-2 - ERROR 2 auto tune error, ATDynaSet expired</li> </ul>	
OutGains	Gains calculated after AutoTune sequences.	

## Example: How to create a feedback loop for the manipulated value

Adding a feedback loop for the manipulated value prevents excessive overshooting by providing a minimum and maximum value for the MV.

### Temperature feedback loop example

At the beginning of the temperature control process, the difference between the process value (PV) and the setpoint value (SP) is large, as shown in the following graph. In this example of a temperature feedback loop, the PV starts at 0 degrees Celsius and moves towards the SP value of 40 degrees Celsius. Notice also that the fluctuation between the high and low manipulated value (MV) decreases and stabilizes with time. The behavior of the MV depends on the values used in each of the P, I, and D parameters.

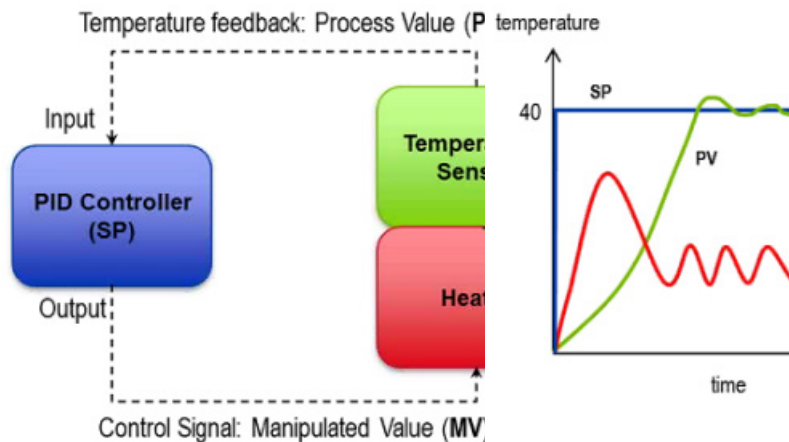

### IPIDController with a feedback loop

The following function block diagram includes a feedback loop for the manipulated value that prevents excessive overshooting by providing a minimum and maximum value for the MV.

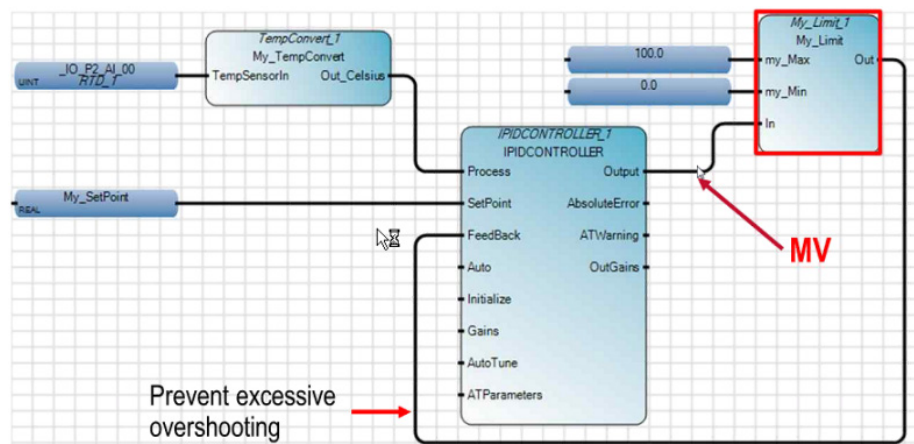

### Example: How to add a UDFB to a PID program

For PID programs, use user-defined function blocks (UDFB) outside the main program to perform specialized functions such as converting units or transferring values. The following are examples of UDFBs.

#### Transfer the auto-tune gain value

This UDFB transfers the Autotune gain value to My\_GainTransfer so it can be used by the controller.



#### Convert a manipulated value to a digital output

This UDFB converts a manipulated value (MV) to a digital output (DO) so it can be used to control a digital input n(DI).

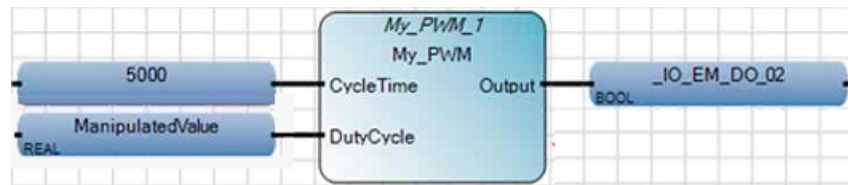

#### Convert a manipulated value to an analog output

This UDFB converts a manipulated value (MV) to an analog output (AO) so it can be used to control an analog input (AI).

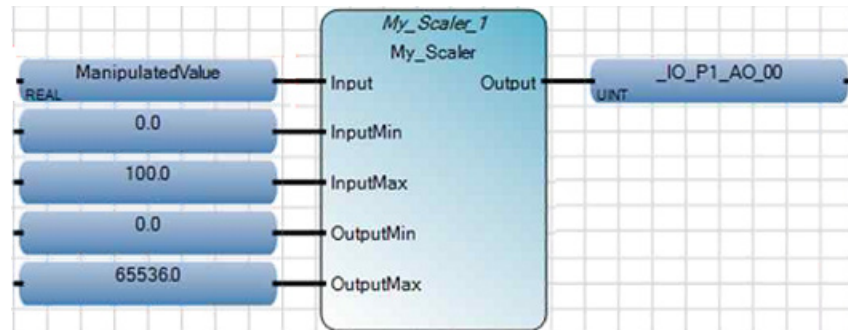

### Example: How to create an IPIDController program to control temperature

The temperature control program maintains the temperature within the control zone.

#### Setpoint, process and manipulated values

The following table defines the SP, PV, and MV values used in the temperature control program.

Item	Description
------	-------------

Item	Description
Setpoint (SP)	Measurement of temperature in degrees Celsius that defines the temperature for the control zone.
Process value (PV)	Must be converted to the same unit as the SP, which is a measurement of degrees Celsius.
Manipulated value (MV)	Must be converted to an analog value so it can be output to the PWM to control the heating element.

### Temperature control system

The following diagram and table define the components in the temperature control system that are controlled by the temperature control program the events that occur when the control program runs.

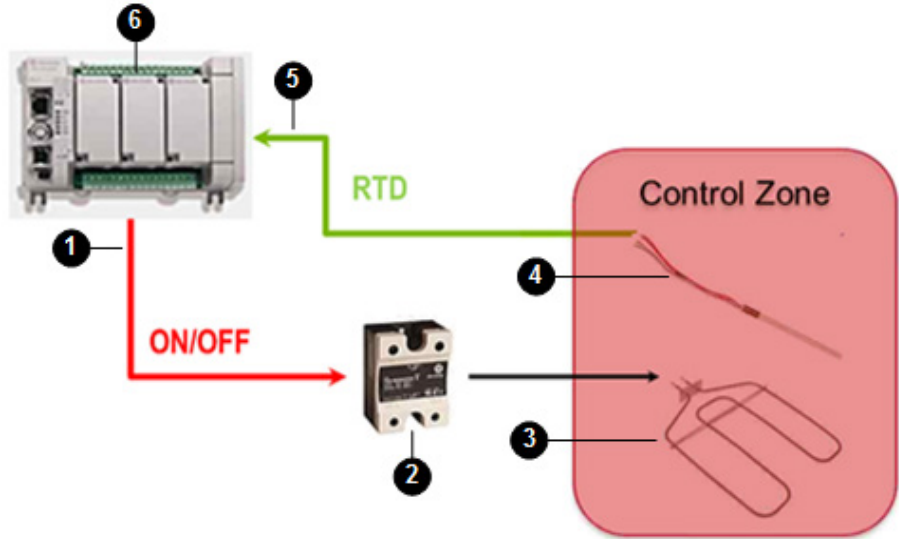

### Sequence of events for temperature control program

The following table identifies the components in the temperature control system and describes the sequence of events that occurs in the system when the temperature control program runs.

No	Item	Description
1	Controller output	Sends the MV to the PWM (On/Off).
2	Pulse Width Modulation (PWM temperature controller)	Solid state relay that controls the heating element.
3	Heating element	Increases temperature in the control zone.
4	Resistance temperature detector (RTD)	Measures the temperature in the control zone and sends the PV (RTD signal) to the controller input.
5	Controller input	Receives the PV (RTD signal).
6	PLC program	Converts the PV (RTD signal) to the same unit as the SP (degrees Celsius) and determines the difference between the PV and the SP and adjusts the MV according to the parameter values defined in the P, I and D parameters.

### Example: Function block diagram to control temperature

This function block diagram shows the predefined and user-defined function blocks used in the application to control temperature in a control zone.

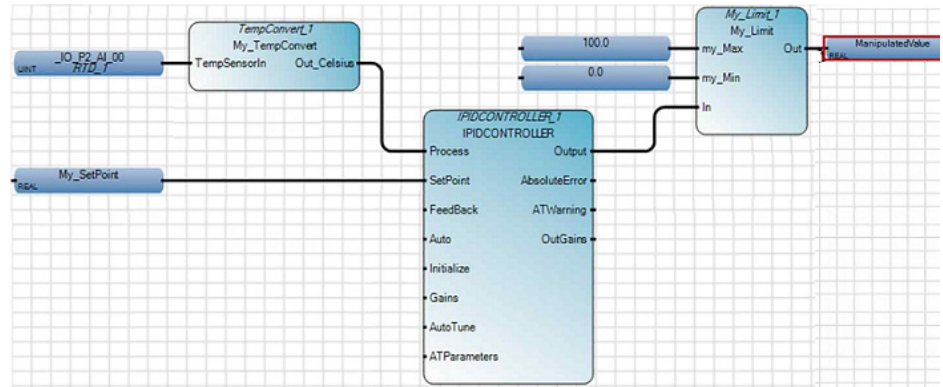

### Example: How to create an IPIDController program to control water supply level

The water supply level control program example maintains sufficient water in a water supply tank that has an outflow. A solenoid valve controls incoming water and fills the tank at a preset rate; outflowing water is also controlled at a preset rate.

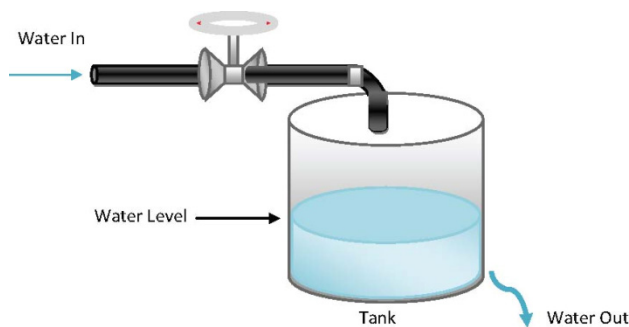

### Program example information

The water supply level program example includes the following information.

- The sequence of events that occur in the control process
- How the setpoint, process and manipulated values are used in the control program
- An example function block diagram that shows the IPIDController and other instruction blocks

### Setpoint, process and manipulated values

The following table defines how the SP, PV, and MV values are used in the water supply level program.

Item	Description
Setpoint (SP)	Measurement of height that defines the target water supply level.
Process value (PV)	The 4-20mA must be converted to the same unit as the SP, which is a measurement of height.
Manipulated value (MV)	Must be converted to an analog value so it can be output to the drive to control the pump.

### Water supply level system

The following diagram shows the components in the water supply level system that are controlled by the water supply level program. The table following the diagram describes the events that occur when the control program runs.

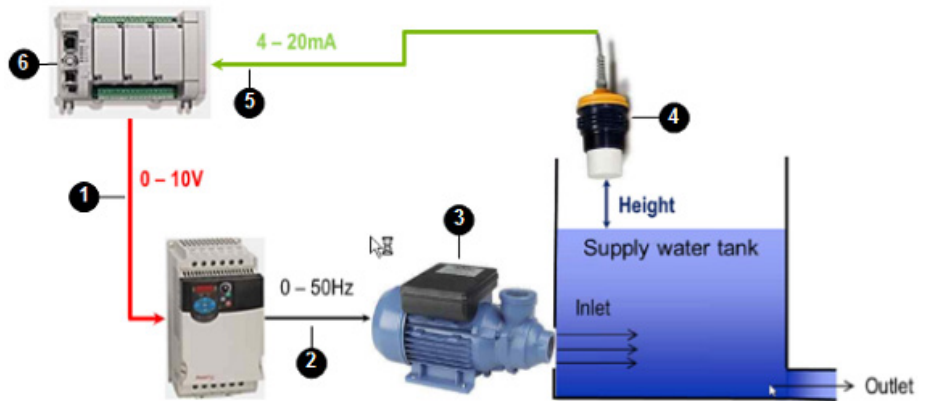

### Sequence of events in water supply level system

The following table identifies the components in the water supply system and describes, in sequence, the events that occur in the system when the water supply level program runs.

No	Item	Description
1	Controller output	Sends the MV to the PowerFlex drive (0-10V).
2	PowerFlex drive	Controls the water pump (0-50Hz).
3	Water pump	Controls the water level in the supply tank.
4	Output transfer device	Measures the height of the water supply level (4-20mA) and sends the PV to the controller.
5	Controller input	Receives the PV (water supply level of 4-20mA).
6	PLC program	Converts the PV to the same unit as the SP (measurement of height) and determines the difference between the PV and SP and adjusts the MV according to the parameter values defined in the P, I and D parameters.

### Example: Function block diagram to control water supply level

The following function block diagram shows the predefined and user-defined function blocks for the program to control the water supply level.

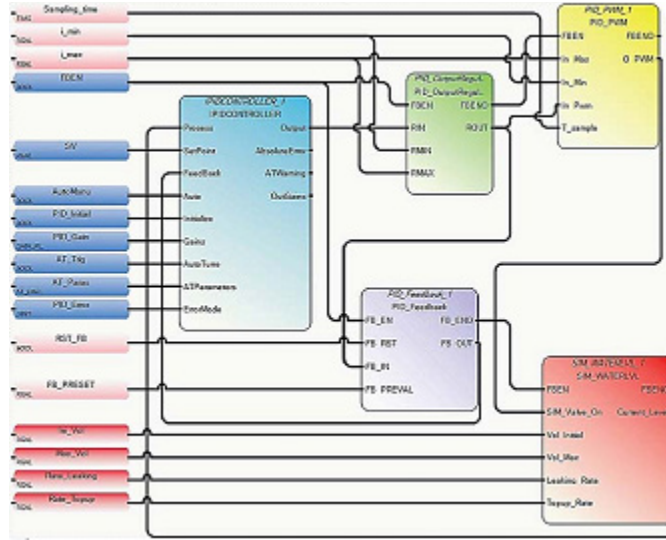

### Function blocks and UDFBs used in the water level FBD

This application, developed in the Function Block Diagram (FBD) language, uses the instructions described in the following table.

Function block	Description
IPIDController function block	Provides PID process control.
PID_OutputRegulator UDFB	Regulates the output of the IPIDCONTROLLER within a safe range to ensure the hardware used in the process is not damaged. <b>Sample code:</b> IF $RMIN \leq RIN \leq RMAX$ , then $ROUT = RIN$ , IF $RIN < RMIN$ , then $ROUT = RMIN$ , IF $RIN > RMAX$ , then $ROUT = RMAX$
PID_Feedback UDFB	Acts as a multiplexer. <b>Sample code:</b> IF "FB_RST" is false, $FB\_OUT=FB\_IN$ ; If "FB_RST" is true, then $FB\_OUT=FB\_PREVAL$ .
PID_PWM UDFB	Provides a PWM function, converting a real value to a time related ON/OFF output.
SIM_WATERLVL UDFB	Simulates the process in the application example.

## PID (proportional-integral-derivative)

An output instruction that controls physical properties such as temperature, pressure, liquid level, or flow rate using process loops.

Operation details:

- When enabled, PID controls the process using the input parameters including SP and Gains of the PID controller.
- Run to Program mode transition, the PID instruction is disabled, parameter values are retained.

- Program to Run mode transition, the PID instruction remains disabled until a user resets Enable to true.

Languages supported: Function Block Diagram, Ladder Diagram, Structured Text.

This instruction applies to the Micro820, Micro830, Micro850, Micro870 controllers and Micro800 Simulator.

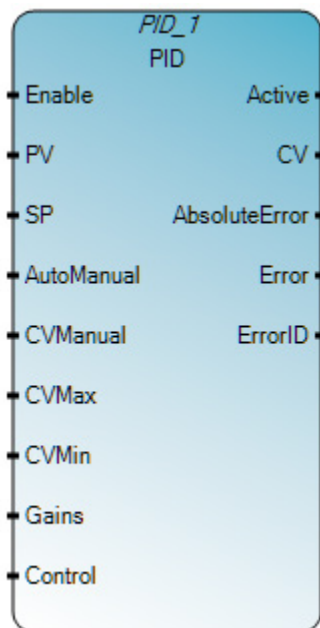

Use this table to help determine the parameter values for this instruction.

Parameter	Parameter Type	Data Type	Description
Enable	Input	BOOL	Enable instruction. TRUE - Start execution with the current input parameters. FALSE - PID does not execute. Set CV to 0 and calculate AbsoluteError.
PV	Input	REAL	Process Value. This value is typically read from an analog input module. The SI unit must be the same as Setpoint.
SP	Input	REAL	The set point value for the process.
AutoManual	Input	BOOL	Auto or manual mode selection. TRUE - CV is controlled by PID. FALSE - PID is running and CV is controlled by CVManual input.
CVManual	Input	REAL	Control value input defined for manual mode operation. The valid range for CVManual is: CVMin < CVManual < CVMax
CVMin	Input	REAL	Control value minimum limit. If CV < CVMin, then CV = CVMin. If CVMin > CVMax, an error occurs.
CVMax	Input	REAL	Control value maximum limit. If CV > CVMax, then CV = CVMax. If CVMax < CVMin, an error occurs.
Gains	Input	PID_GAINS	Gains of PID for controller. Use the PID_GAINS data type to configure the Gains parameter.



Control	Input	BOOL	Control direction of the process: TRUE - Direct acting, such as Cooling. FALSE - Reverse acting, such as Heating.
Active	Output	BOOL	Status of the PID controller. TRUE - PID is active. FALSE - PID is stopped.
CV	Output	REAL	The control value output. If any error occurred, CV is 0.
AbsoluteError	Output	REAL	Absolute error is the difference between process value (PV) and set point (SP) value.
Error	Output	BOOL	Indicates the existence of an error condition. TRUE - Operation encountered an Error. FALSE - Operation completed successfully or the instruction is not executing.
ErrorID	Output	USINT	A unique numeric that identifies the error. The errors are defined in PID error codes.

### PID\_GAINS data type

The following table describes the PID\_GAINS data type for the [PID instruction](#) on [page 529](#).

Parameter	Parameter Type	Data Type	Description
Kc	Input	REAL	Controller gain for PID. Proportional and Integral are dependent on this gain. ( $\geq 0.0001$ ). Increasing Kc improves response time but also increases overshoot and oscillation of the PID. If Kc is invalid, an error occurs.
Ti	Input	REAL	Time integral constant in seconds ( $\geq 0.0001$ ). Increasing Ti decreases the overshoot and oscillation of the PID. If Ti is invalid, an error occurs.
Td	Input	REAL	Time derivative constant in seconds ( $\geq 0.0$ ). When Td equals 0, there is no derivative action and PID becomes a PI controller. Increasing Td reduces the overshoot and removes the oscillation of the PID controller. If Td is invalid, an error occurs.
FC	Input	REAL	Filter constant ( $\geq 0.0$ ). Recommended range for FC is 0 to 20. Increasing FC smooths the response of the PID controller. If FC is invalid, an error occurs.

### PID error codes

Use this table to determine the PID error codes and descriptions.

Error code	Error description
0	PID is working normally.
1	Kc is invalid.
2	Ti is invalid.
3	Td is invalid.
4	FC is invalid.
5	CVMin > CVMax or CVMax < CVMin
6	CVManual < CVMin CVManual is invalid.

Error code	Error description
0	PID is working normally.
1	Kc is invalid.
2	Ti is invalid.
7	CVManual > CVMax CVManual is invalid.

### PID Function Block Diagram example

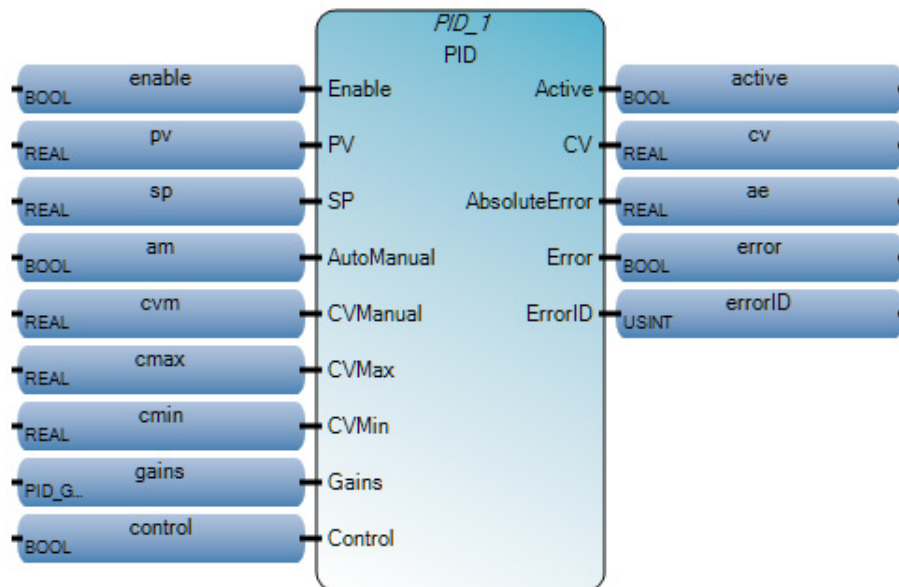

### PID Ladder Diagram example

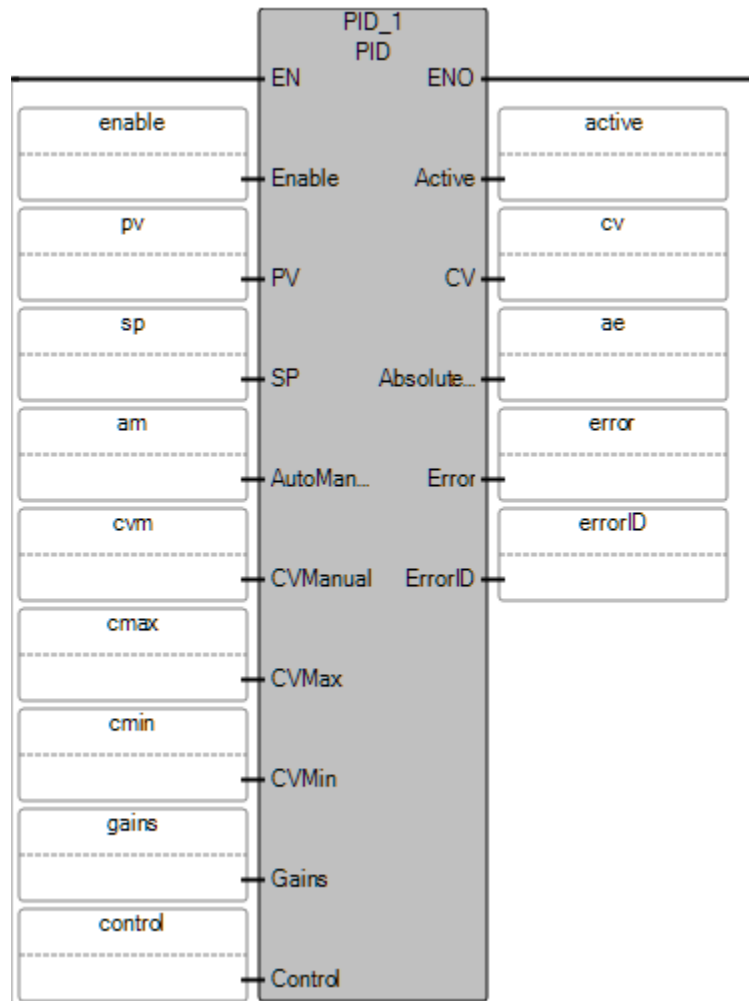

### PID Structured Text example

```

1 PID_1(enable, pv, sp, am, cvm, cmax, cmin, gains, control);
2 active := PID_1.Active;
3 cv := PID_1.CV;
4 ae := PID_1.AbsoluteError;
5 error := PID_1.Error;
6 errorID := PID_1.ErrorID;

```

```

1 PID_1(
void PID_1(BOOL Enable, REAL PV, REAL SP, BOOL AutoManual, REAL CVManual, REAL CVMax, REAL CVMin, PID_GAINS Gains, BOOL Control)
Type: PID, Proportional Integral Derivative.

```

### PID Results

Name	Alias	Logical Value	Physical Value	Initial Value	Lock	Data Type
PID_1		...	...	...		PID
enable		<input checked="" type="checkbox"/>	N/A		<input type="checkbox"/>	BOOL
pv		1.0	N/A	1.0	<input type="checkbox"/>	REAL
sp		10.0	N/A	10.0	<input type="checkbox"/>	REAL
am		<input type="checkbox"/>	N/A		<input type="checkbox"/>	BOOL
cvm		20.0	N/A	20.0	<input type="checkbox"/>	REAL
cmax		30.0	N/A	30.0	<input type="checkbox"/>	REAL
cmin		1.0	N/A	1.0	<input type="checkbox"/>	REAL
gains		...	...	...	<input type="checkbox"/>	PID_GAINS
control		<input type="checkbox"/>	N/A		<input type="checkbox"/>	BOOL
errorID		0	N/A		<input type="checkbox"/>	USINT
error		<input type="checkbox"/>	N/A		<input type="checkbox"/>	BOOL
ae		9.0	N/A		<input type="checkbox"/>	REAL
active		<input checked="" type="checkbox"/>	N/A		<input type="checkbox"/>	BOOL
cv		20.0	N/A		<input type="checkbox"/>	REAL

### PID instruction state machine

The PID State Machine diagram describes the processing states for the [PID instruction](#) on [page 551](#).

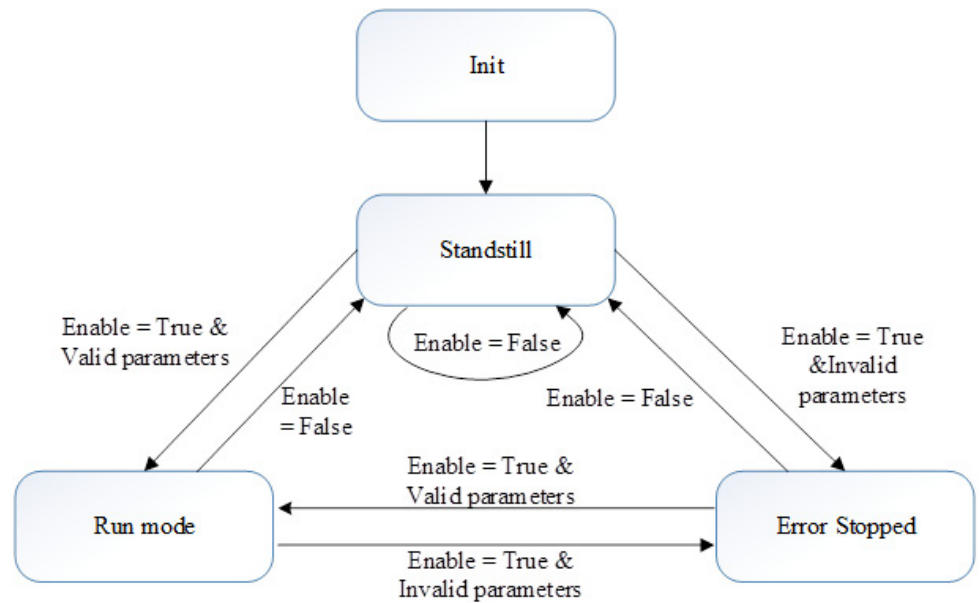

### PID instruction timing diagrams

The following timing diagram examples describe execution scenarios for the [PID \(proportional-integral-derivative\) instruction](#) on [page 551](#).

### Successful PID execution

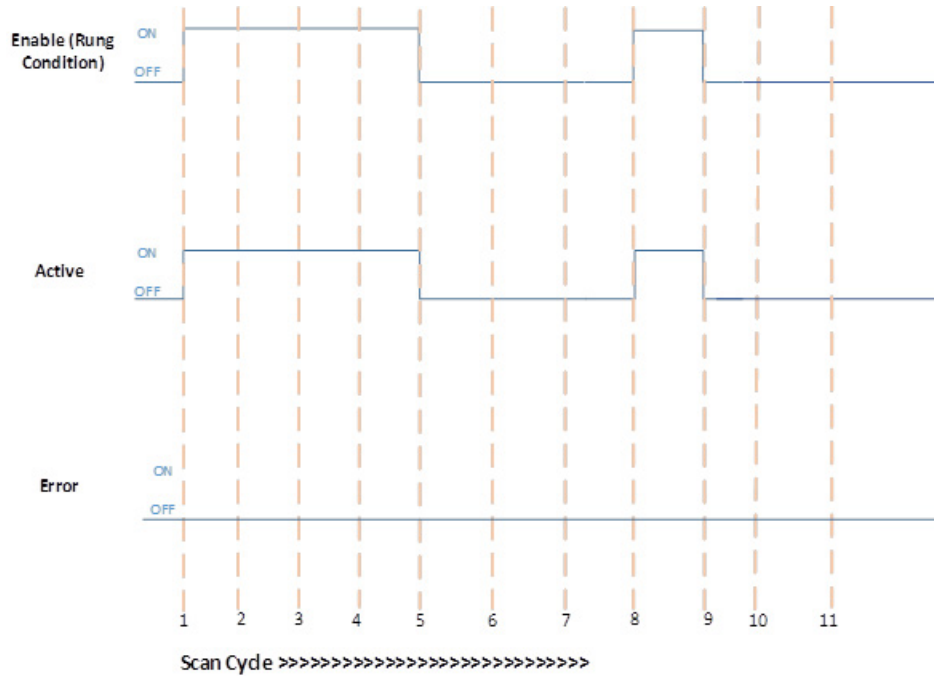

Use this table to help determine the parameter values for each scan cycle.

Scan Cycle	Description
1, 8	Rung condition becomes TRUE when: <ul style="list-style-type: none"> <li>• Enable input bit is TRUE.</li> <li>• Input parameters are valid.</li> <li>• Active bit is TRUE.</li> <li>• Error bit is FALSE.</li> </ul>
2,3,4	No change in Rung condition. <ul style="list-style-type: none"> <li>• Enable input bit is TRUE.</li> <li>• Input parameters are valid.</li> <li>• Updates PID output parameters.</li> </ul>
5, 9	Rung condition becomes FALSE when: <ul style="list-style-type: none"> <li>• Enable bit is FALSE.</li> <li>• Clears PID output parameters except AbsoluteError.</li> <li>• AbsoluteError calculates based on PV and SP input values.</li> </ul>
6, 7, 10, 11	No change in Rung condition. <ul style="list-style-type: none"> <li>• Enable bit is FALSE.</li> <li>• Clears PID output parameters except AbsoluteError.</li> <li>• AbsoluteError calculates based on PV and SP input values.</li> </ul>

### PID execution with Error

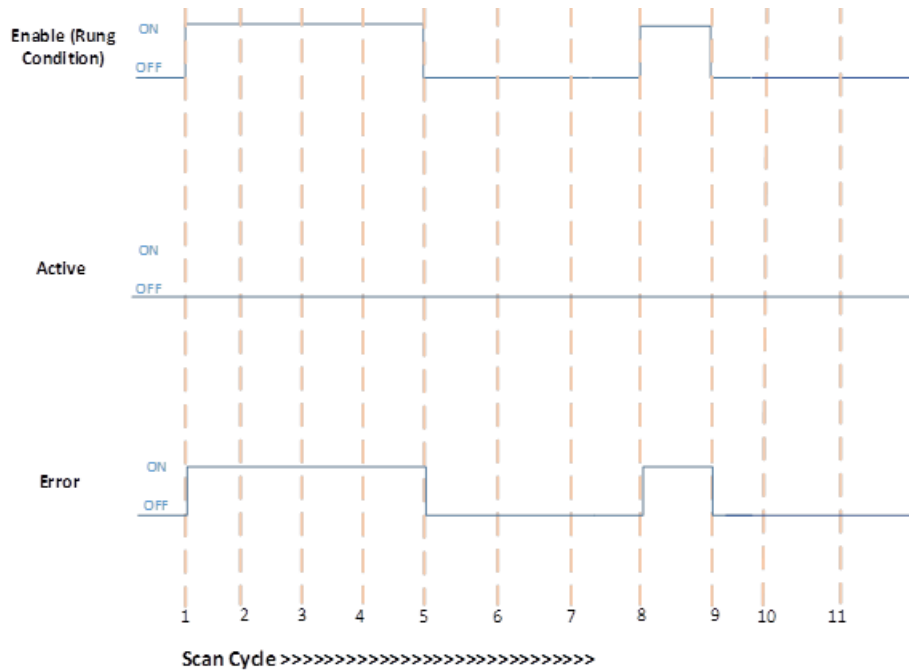

Use this table to help determine the parameter values for each scan cycle.

Scan Cycle	Description
1, 8	Rung condition becomes TRUE when: <ul style="list-style-type: none"> <li>• Enable input bit is TRUE.</li> <li>• Input parameters are invalid.</li> <li>• Active bit is FALSE.</li> <li>• Error bit is TRUE. ErrorID output is set.</li> <li>• CV output is set to 0.</li> <li>• AbsoluteError calculates based on PV and SP input values.</li> </ul>
2,3,4	No change in Rung condition. <ul style="list-style-type: none"> <li>• Enable input bit is TRUE.</li> <li>• Input parameters are invalid.</li> <li>• Updates PID output parameters.</li> </ul>
5, 9	Rung condition becomes FALSE when: <ul style="list-style-type: none"> <li>• Enable bit is FALSE.</li> <li>• Clears PID output parameters except AbsoluteError.</li> <li>• AbsoluteError calculates based on PV and SP input values.</li> </ul>
6, 7, 10, 11	No change in Rung condition. <ul style="list-style-type: none"> <li>• Enable bit is FALSE.</li> <li>• Clears PID output parameters except AbsoluteError.</li> <li>• AbsoluteError calculates based on PV and SP input values.</li> </ul>

### PID execution with Error then successful execution

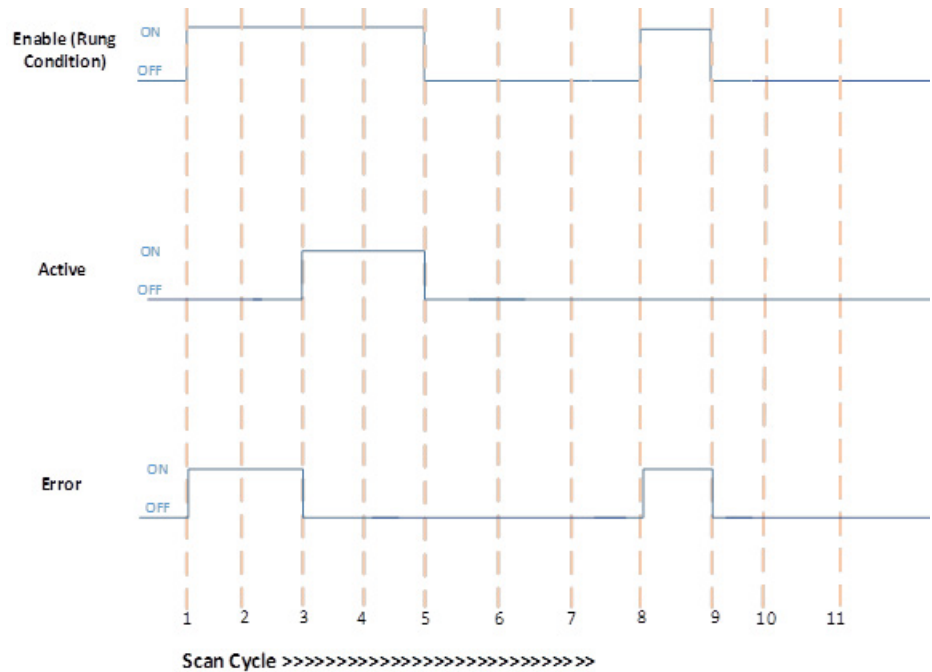

Use this table to help determine the parameter values for each scan cycle.

Scan Cycle	Description
1, 8	Rung condition becomes TRUE when: <ul style="list-style-type: none"> <li>• Enable input bit is TRUE.</li> <li>• Input parameters are invalid.</li> <li>• Active bit is FALSE.</li> <li>• Error bit is TRUE. ErrorID output is set.</li> <li>• CV output is set to 0.</li> <li>• AbsoluteError calculates based on PV and SP input values.</li> </ul>
2	No change in Rung condition. <ul style="list-style-type: none"> <li>• Enable input bit is TRUE.</li> <li>• Input parameters are invalid.</li> <li>• Updates PID output parameters.</li> </ul>
3, 4	No change in Rung condition. <ul style="list-style-type: none"> <li>• Enable input bit is TRUE.</li> <li>• Input parameters are valid.</li> <li>• Active bit is TRUE.</li> <li>• Error bit is FALSE.</li> <li>• Updates PID output parameters.</li> </ul>
5, 9	Rung condition becomes FALSE when: <ul style="list-style-type: none"> <li>• Enable bit is FALSE.</li> <li>• Clears PID output parameters except AbsoluteError.</li> <li>• AbsoluteError calculates based on PV and SP input values.</li> </ul>
6, 7, 10, 11	No change in Rung condition. <ul style="list-style-type: none"> <li>• Enable bit is FALSE.</li> <li>• Clears PID output parameters except AbsoluteError.</li> <li>• AbsoluteError calculates based on PV and SP input values.</li> </ul>

### Successful PID execution and Error

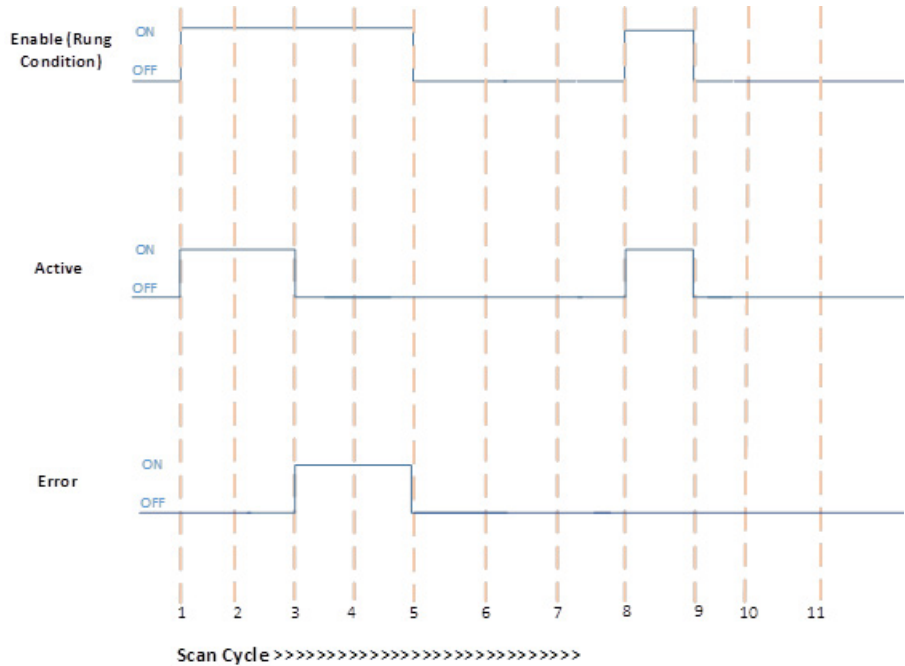

Use this table to help determine the parameter values for each scan cycle.

Scan Cycle	Description
1, 8	Rung condition becomes TRUE when: <ul style="list-style-type: none"> <li>• Enable input bit is TRUE.</li> <li>• Input parameters are valid.</li> <li>• Active bit is TRUE.</li> <li>• Error bit is FALSE.</li> <li>• Update PID output parameters.</li> </ul>
2	No change in Rung condition. <ul style="list-style-type: none"> <li>• Enable input bit is TRUE.</li> <li>• Input parameters are valid.</li> <li>• Update PID output parameters.</li> </ul>
3, 4	No change in Rung condition. <ul style="list-style-type: none"> <li>• Enable input bit is TRUE.</li> <li>• Input parameters are invalid.</li> <li>• Error bit is TRUE. ErrorID output is set.</li> <li>• CV output is set to 0.</li> <li>• AbsoluteError calculates based on PV and SP input values.</li> </ul>
5, 9	Rung condition becomes FALSE when: <ul style="list-style-type: none"> <li>• Enable bit is FALSE.</li> <li>• Clear PID output parameters except AbsoluteError.</li> <li>• AbsoluteError calculates based on PV and SP input values.</li> </ul>
6, 7, 10, 11	No change in Rung condition. <ul style="list-style-type: none"> <li>• Enable bit is FALSE.</li> <li>• Clears PID output parameters except AbsoluteError.</li> <li>• AbsoluteError calculates based on PV and SP input values.</li> </ul>



## Real Time Clock (RTC) instructions

Use Real Time Clock instructions to configure the calendar and the clock.

Instruction	Description
<a href="#">RTC_READ</a> on <a href="#">page 385</a>	Reads the real-time clock (RTC) module information.
<a href="#">RTC_SET</a> on <a href="#">page 387</a>	Sets real-time clock data to the RTC module information.

### RTC\_READ (read real-time clock)

Reads the real-time clock (RTC) module information.

Operation details:

- Micro810 or Micro820 controller with embedded RTC:
  - RTCBatLow is always set to zero (0).
  - RTCEnabled is always set to one (1).
- When the embedded RTC has lost its charge/memory due to loss of power:
  - RTCData is set to 2000/1/1/0/0/0.
  - RTCEnabled is set to one (1).

Languages supported: Function Block Diagram, Ladder Diagram, Structured Text.

This instruction applies to the Micro810, Micro820, Micro830, Micro850, Micro870 controllers and Micro800 Simulator.

The outputs are always reset when the instruction is applied to the simulated controller (2080-LC50-48QWB-SIM).

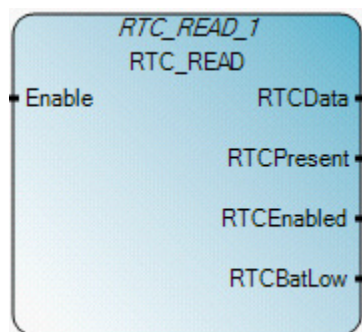

Use this table to help determine the parameter values for this instruction.

Parameter	Parameter Type	Data Type	Description
-----------	----------------	-----------	-------------

Enable	Input	BOOL	Instruction block enable. TRUE - execute RTC information read. FALSE - there is no read operation and output RTC data is invalid.
RTCData	Output	RTC	RTC data information: yy/mm/dd, hh/mm/ss, week. RTCData output is defined using the RTC data type.
RTCPresent	Output	BOOL	TRUE - Free Running clock is utilized, or RTC hardware is plugged in. FALSE - Free Running clock is not utilized, or RTC hardware is not plugged in.
RTCEnabled	Output	BOOL	TRUE - Free Running clock is utilized, or RTC hardware is enabled (timing). FALSE - Free Running clock is not utilized, RTC hardware is disabled (not timing).
RTCBatLow	Output	BOOL	TRUE - RTC battery is low. FALSE - RTC battery is not low.
ENO	Output	BOOL	Enable output. Applies only to Ladder Diagram programs.

### RTC data type

Use this table to help determine the parameter values for the RTC data type.

Parameter	Data type	Description
Year	UINT	The year setting for the RTC. 16-bit value, and the valid range is from 2000 (Jan 01, 00:00:00) to 2098 (Dec. 31, 23:59:59)
Month	UINT	The month setting for the RTC.
Day	UINT	The day setting for the RTC.
Hour	UINT	The hour setting for the RTC.
Minute	UINT	The minute setting for the RTC.
Second	UINT	The second setting for the RTC.
DayOfWeek	UINT	The day of the week setting for the RTC. This parameter is ignored for RTC_SET.

### RTC\_READ Function Block Diagram example

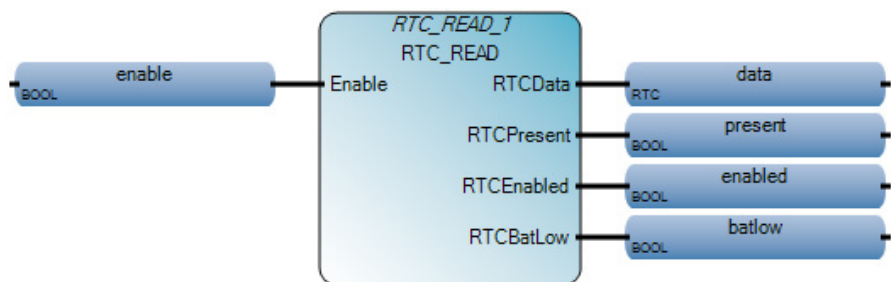

### RTC\_READ Ladder Diagram example

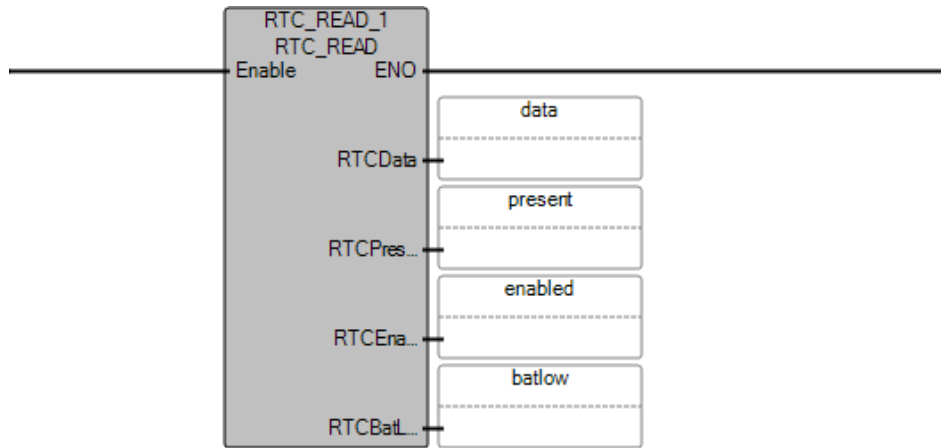

### RTC\_READ Structured Text example

```
RTC_READ_1(
void RTC_READ_1(BOOL Enable)
Type : RTC_READ, Read RTC module information.
```

```
1 RTC_READ_1(enable);
2 data := RTC_READ_1.RTCData;
3 present := RTC_READ_1.RTCPresent;
4 enabled := RTC_READ_1.RTCEnabled;
5 batlow := RTC_READ_1.RTCBatLow;
```

## RTC\_SET (set real-time clock)

Set RTC (real-time clock) data to the RTC module information.

Languages supported: Function Block Diagram, Ladder Diagram, Structured Text.

This instruction applies to the Micro810, Micro820, Micro830, Micro850, Micro870 controllers and Micro800 Simulator.

The outputs are always reset when the instruction is applied to the simulated controller (2080-LC50-48QWB-SIM).

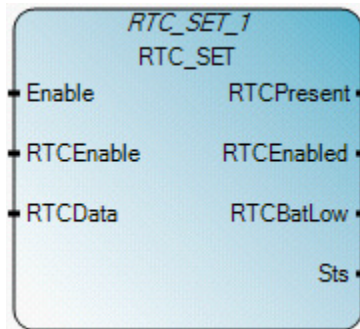

Use this table to help determine the parameter values for this instruction.

Parameter	Parameter Type	Data Type	Description
-----------	----------------	-----------	-------------

Enable	Input	BOOL	Instruction block enable. TRUE - execute RTC_SET with the RTC information from input. Typically, only execute for 1 program scan when updating the RTC. FALSE - do not execute RTC_SET. Set to FALSE to operate RTC normally.
RTCEnable	Input	BOOL	TRUE - To enable RTC with the RTC data specified. FALSE - To disable RTC.
RTCData	Input	RTC	RTC data information: yy/mm/dd, hh/mm/ss, week as defined in the RTC data type. RTCData is ignored when RTCEnable = 0.
RTCPresent	Output	BOOL	TRUE - Free Running clock is utilized, or RTC hardware is plugged in. FALSE - Free Running clock is not utilized, or RTC hardware is not plugged in.
RTCEnabled	Output	BOOL	TRUE - Free Running clock is utilized, or RTC hardware is enabled (timing). FALSE - Free Running clock is not utilized, or RTC hardware is disabled (not timing).
RTCBatLow	Output	BOOL	TRUE - RTC battery is low. FALSE - RTC battery is not low.
Sts	Output	USINT	The read operation status. RTC_Set status (Sts) values: <ul style="list-style-type: none"> <li>• 0x00 - Function block not enabled (no operation).</li> <li>• 0x01 - RTC set operation success.</li> <li>• 0x02 - RTC set operation fails.</li> </ul>

### RTC data type

Use this table to help determine the parameter values for the RTC data type.

Parameter	Data type	Description
Year	UINT	The year setting for the RTC. 16-bit value, and the valid range is from 2000 (Jan 01, 00:00:00) to 2098 (Dec. 31, 23:59:59)
Month	UINT	The month setting for the RTC.
Day	UINT	The day setting for the RTC.
Hour	UINT	The hour setting for the RTC.
Minute	UINT	The minute setting for the RTC.
Second	UINT	The second setting for the RTC.
DayOfWeek	UINT	The day of the week setting for the RTC. This parameter is ignored for RTC_SET.

### RTC\_SET Function Block Diagram example

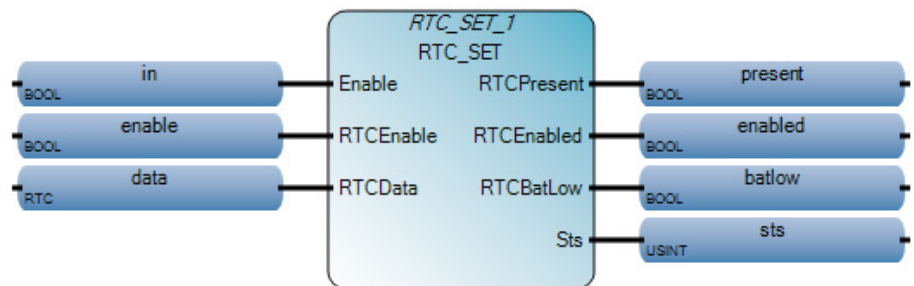

## RTC\_SET Ladder Diagram example

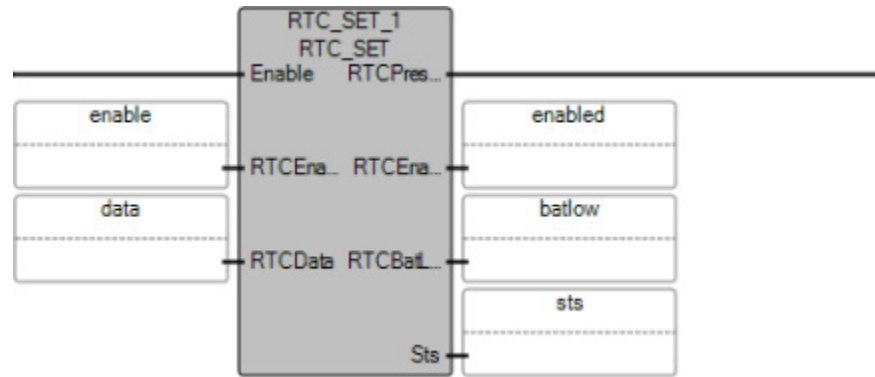

## RTC\_SET Structured Text example

```

RTC_SET_1(
void RTC_SET_1(BOOL Enable, BOOL RTCEnable, RTC RTCData)
Type : RTC_SET, Set RTC data to RTC module.

1 | RTC_SET_1(in, enable, data);
2 | present := RTC_SET_1.RTCPresent;
3 | enabled := RTC_SET_1.RTCEnabled;
4 | batlow := RTC_SET_1.RTCBatLow;
5 | sts := RTC_SET_1.Sts;

```



## Socket instructions

Use the Sockets protocol for Ethernet communications to devices that do not support Modbus TCP and EtherNet/IP. Sockets support client, server, Transmission Control Protocol (TCP), and User Datagram Protocol (UDP). Typical applications include communicating to printers, bar codes readers, and personal computers.

Socket instruction behavior in **Run Mode Change** mode:

- If a delete operation is performed on a SOCKET\_OPEN, SOCKET\_ACCEPT, SOCKET\_READ, or SOCKET\_WRITE instruction while in **Run Mode Change** mode, the Socket instance is deleted.
- In **Run Mode Change** mode, any change to a SOCKET\_READ input while operating in the BUSY state results in an error and the received packet is discarded. SOCKET\_READ input parameters are: Length, Offset, Data Array Size, Data Array Variable.
- SOCKET\_READ is the only SOCKET instruction that supports add or modify operations while in **Run Mode Change** mode.
- If the Ethernet IP settings are modified using **Run Mode Change** all created Socket instances are deleted, similar to SOCKET\_DELETEALL.

Instruction Processing and Output Updates for Socket instructions:

- **Asynchronous:** Respective instructions where all outputs update asynchronously with user program scan, for example a Ladder scan. Asynchronous output can not be used for edge trigger detection. Asynchronous output parameters are not locked and can be updated after completion of respective socket instructions.
- **Synchronous:** Respective instructions where all output update is in sync with user program scans. Synchronous output parameters are locked and can not be modified after completion of respective socket instruction.
- **Hybrid:** Respective instructions where a few outputs update in sync with user program scan. Remaining outputs update asynchronously with user program scan.
- **Immediate Instruction Execution:** Instruction completes desired function prior to going to next instruction.
- **Non-Immediate Instruction Execution:** Instruction takes more than one program scan to complete desired function. Instructions take a snap shot of input parameters when a **False > True** transition is detected.

Use this table to help determine Socket instructions usage.

Instruction	Description	TCP Client	TCP Server	UDP with Open	UDP without Open	Instruction Processing	Instruction Output Update
<a href="#">SOCKET_ACCEPT</a> on <a href="#">page 568</a>	Accepts a TCP connection request from a remote destination and returns a socket instance used to send and receive data on the newly created connection.	NO	YES	NO	NO	Non-Immediate	Hybrid
<a href="#">SOCKET_CREATE</a> on <a href="#">page 571</a>	Creates an instance of the Socket and returns an instance number that uses the next socket operations.	YES	YES	YES	YES	Immediate	Synchronous
<a href="#">SOCKET_DELETE</a> on <a href="#">page 576</a>	Deletes a created socket instance. TCP connections are closed prior to deletion.	YES	YES	YES	YES	Non-Immediate	Synchronous
<a href="#">SOCKET_DELETEALL</a> on <a href="#">page 578</a>	Deletes all created socket instances.	YES	YES	YES	YES	Non-Immediate	Synchronous
<a href="#">SOCKET_INFO</a> on <a href="#">page 580</a>	Returns information for the socket such as error codes and execution status.	YES	YES	YES	YES	Immediate	Synchronous
<a href="#">SOCKET_OPEN</a> on <a href="#">page 586</a>	TCP connections open with the specified destination address. UDP connections associate a destination IP address and port number with the specified socket.	YES	NO	YES	NO	Non-Immediate	Synchronous
<a href="#">SOCKET_READ</a> on <a href="#">page 590</a>	Reads data on a socket. Attempts to receive the specified number of bytes and returns the number of bytes received.	YES	YES	YES	YES	Non-Immediate	Hybrid
<a href="#">SOCKET_WRITE</a> on <a href="#">page 594</a>	Sends data on a socket. Attempts to send the requested number of bytes and returns the number of bytes sent.	YES	YES	YES	YES	Non-Immediate	Hybrid

## SOCKET\_ACCEPT

For Transmission Control Protocol (TCP) connections only. Accepts a TCP connection request from a remote destination and returns a Socket Instance used to send and receive data on the newly created connection.

Operation details:

- Before executing Socket\_Accept execute SOCKET\_CREATE and specify the local port number for the accept connection.
- Outputs are updated synchronously from the program scan.

Languages supported: Function Block Diagram, Ladder Diagram, Structured Text.

This instruction applies to the Micro820, Micro850, and Micro870 controllers. For the Micro800 Simulator, this instruction can be added to a program but is only a placeholder to prevent the instruction from being deleted during controller change.



The outputs are always reset when the instruction is applied to the simulated controller (2080-LC50-48QWB-SIM).

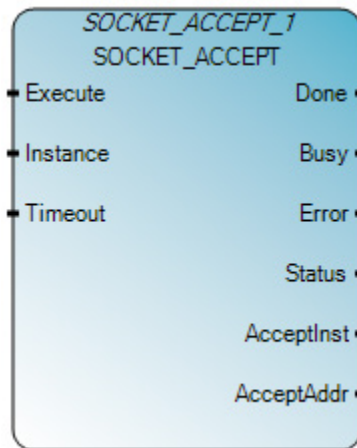

Use this table to help determine the parameter values for this instruction.

Parameter	Parameter type	Data type	Description
Execute	Input	BOOL	Instruction block enable. TRUE - Rising Edge detected, start the instruction block with the precondition that the last operation has been completed. FALSE - no Rising Edge detected; instruction block not started.
Instance	Input	UDINT	Identifies the socket instance. Copy the returned Socket Handler from the <b>SOCKET_CREATE</b> instruction.
Timeout	Input	UDINT	Timeout for the <b>SOCKET_ACCEPT</b> instruction block instances. The function block returns an Error if the timeout value is less than minimum value. Timeout range: 1000- 86400000 milliseconds Set Timeout to 0 to use the default value 10000 (10 Second).
Done	Output	BOOL	Indicates when operation is complete. TRUE - operation completed successfully. FALSE - operation is in progress or encountered an error condition. Output is updated synchronously from the program scan.
Busy	Output	BOOL	TRUE - the operation is not finished. FALSE - the operation is finished. Output is updated synchronously from the program scan.
Error	Output	BOOL	Indicates an error occurred. TRUE - An error is detected. FALSE - No error. Output is updated synchronously from the program scan.
Status	Output	SOCK_STATUS	Status is defined using the <a href="#">SOCK_STATUS data type</a> on <a href="#">page 598</a> which contains <a href="#">ErrorID</a> on <a href="#">page 599</a> , SubErrorID, and <a href="#">StatusBits</a> on <a href="#">page 602</a> information. Output is updated synchronously from the program scan.
AcceptInst	Output	UDINT	Contains the Accept Instance for this Socket Instance. Use the unique Accept Instance number with subsequent <b>SOCKET_READ</b> and <b>SOCKET_WRITE</b> for this connection. Output is updated synchronously from the program scan.

Parameter	Parameter type	Data type	Description
AcceptAddr	Output	SOCKADDR_CFG	<p>A data structure that contains the Accept Address for the socket.</p> <p>For more information, refer to <a href="#">SOCKADDR_CFG data type</a> on <a href="#">page 598</a>.</p> <p>To specify an IP Address of 192.168.2.100 and Port = 12000:</p> <ul style="list-style-type: none"> <li>• AcceptAddr.IPAddress[0]=192</li> <li>• AcceptAddr.IPAddress[1]=168</li> <li>• AcceptAddr.IPAddress[2]=2</li> <li>• AcceptAddr.IPAddress[3]=100</li> <li>• AcceptAddr.Port = 12000</li> </ul> <p>Output is updated synchronously from the program scan.</p>

### SOCKET\_ACCEPT Function Block Diagram example

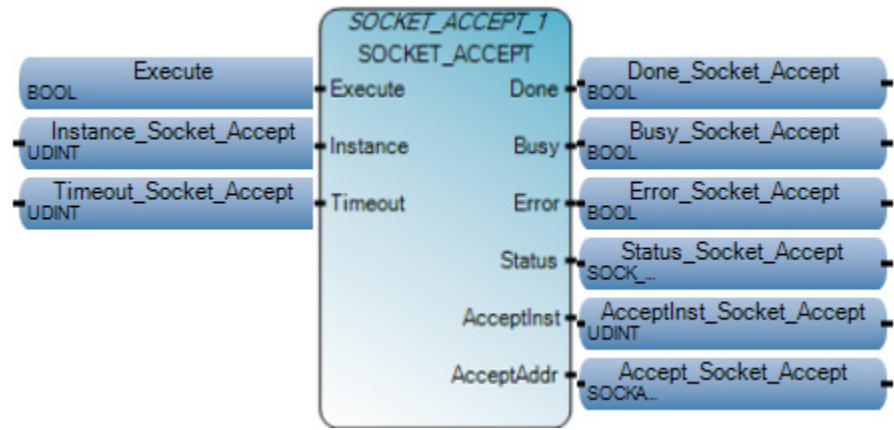

### SOCKET\_ACCEPT Ladder Diagram example

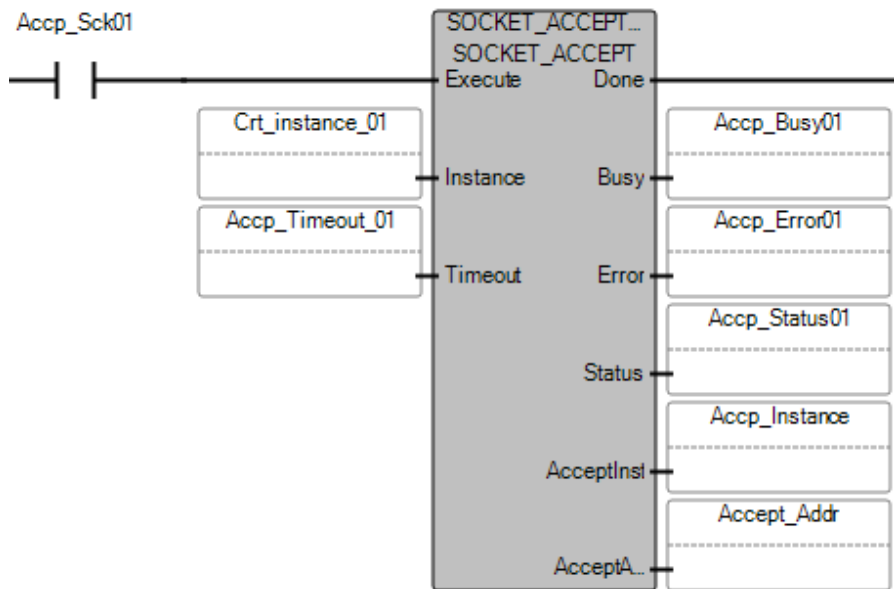

## SOCKET\_ACCEPT Structured Text example

```

SOCKET_ACCEPT_1 (
void SOCKET_ACCEPT_1(BOOL Execute, UDINT Instance, UDINT Timeout)
Type : SOCKET_ACCEPT, Accept Socket

SOCKET_ACCEPT_1(Execute_SOCKET_ACCEPT, Instance_SOCKET_ACCEPT, Timeout_SOCKET_ACCEPT);
Done_SOCKET_ACCEPT := SOCKET_ACCEPT.Done;
Busy_SOCKET_ACCEPT := SOCKET_ACCEPT.Busy;
Error_SOCKET_ACCEPT := SOCKET_ACCEPT.Error;
Status_SOCKET_ACCEPT := SOCKET_ACCEPT.Status;
AcceptInst_SOCKET_ACCEPT := SOCKET_ACCEPT.AcceptInst;
AcceptAddr_SOCKET_ACCEPT := SOCKET_ACCEPT.AcceptAddr;

```

## Results

### TCP Server

Name	Alias	Logical Value	Physical Value	Initial Value	Lock	Data Type
Accp_Status01		...	...	...		SOCK_STATUS
Accp_Status01.ErrorID		0	N/A			USINT
Accp_Status01.SubErrorID		0	N/A			UINT
Accp_Status01.StatusBits		17	N/A			UINT
Accp_Sok01		<input checked="" type="checkbox"/>	N/A			BOOL
Accp_Instance		1076385752	N/A			UDINT
Accp_Error01		<input type="checkbox"/>	N/A			BOOL
Accp_Busy01		<input type="checkbox"/>	N/A			BOOL
Accept_Addr		...	...	...		SOCKADDR_CF
Accept_Addr.Port		30002	N/A			UINT
Accept_Addr.IPAddress		...	...	...		IPADDR
Accept_Addr.IPAddress[0]		10	N/A			USINT
Accept_Addr.IPAddress[1]		224	N/A			USINT
Accept_Addr.IPAddress[2]		68	N/A			USINT
Accept_Addr.IPAddress[3]		221	N/A			USINT

## SOCKET\_CREATE

Creates an instance of the socket and returns an instance number that is used as an input in any follow-on socket operations.

### Operation details:

- [Socket instructions](#) on [page 567](#) support Full Duplex communication with remote devices.
- User Datagram Protocol (UDP) connections supports a maximum of eight queued UDP datagrams packets. The queue contains the most recent packets.
- Micro820 and Micro850 controllers at revision 9 or higher support up to eight Socket Instances. The Socket instances support UDP and TCP Sockets:
  - Use all eight instances for client Transmission Control Protocol (TCP) connections.
  - Use all eight instances to listen for incoming TCP connections and then accept eight connections from other devices.
  - Perform both TCP client and server operations.
  - Perform both TCP and UDP operations.

- To accept incoming TCP connections to the same port, create a new Socket Instance.
- TCP Connection Loss:
  - User application program should detect the loss of TCP connections and handle the event. Depending on the user application, consider the option to Fault the controller.
    - Fault the controller.
    - Try to re-establish the connection.
  - To re-establish communications with another device:
    - Delete the Socket Instance for the lost connection.
    - If the connection is a TCP client, create a new Socket Instance using SOCKET\_CREATE and execute SOCKET\_OPEN to the target device.
    - If the connection is a TCP server, create a new Socket Instance using SOCKET\_CREATE and execute SOCKET\_ACCEPT to wait for another connection from the remote device.
- Application Messages for TCP connections:
  - A TCP connection is a byte stream between two applications. The application protocol determines the message formats.
  - Messages can be fixed size or variable size.

Languages supported: Function Block Diagram, Ladder Diagram, Structured Text.

This instruction applies to the Micro820, Micro850, and Micro870 controllers. For the Micro800 Simulator, this instruction can be added to a program but is only a placeholder to prevent the instruction from being deleted during controller change.

The outputs are always reset when the instruction is applied to the simulated controller (2080-LC50-48QWB-SIM).

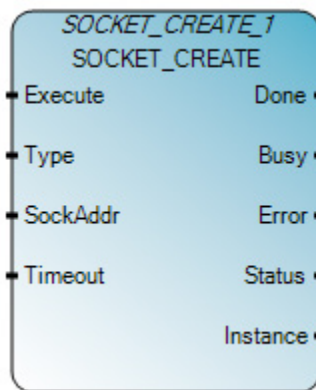

Use this table to help determine the parameter values for this instruction.

Parameter	Parameter type	Data type	Description
-----------	----------------	-----------	-------------

Parameter	Parameter type	Data type	Description
Execute	Input	BOOL	Instruction block enable. TRUE - Rising Edge detected, start the instruction block with the precondition that the last operation has been completed. FALSE - no Rising Edge detected.
Type	Input	USINT	Specify the Type of Socket: <ul style="list-style-type: none"> <li>• Transmission Control Protocol (TCP).</li> <li>• User Datagram Protocol (UDP).</li> </ul>
SockAddr	Input	SOCKADDR_CFG	Specify the address configuration for the socket. The EtherNet/IP module to choose the local port number, set SockAddr to 0. Specify the local port number where an application is listening and receiving, or : <ul style="list-style-type: none"> <li>• Array elements must all be zero</li> <li>• For TCP client operations, specify 0 unless you want a specific local port number.</li> <li>• For TCP server communication, specify the port number to accept incoming connection requests.</li> <li>• For UDP, specify a local port number to receive datagrams on a specific port.</li> </ul> Local port range: 1 to 65535. An error occurs if the specified local port number is already in use by the Micro820 or Micro850 controller. The controller uses the following port numbers: TCP Ports: <ul style="list-style-type: none"> <li>• EtherNet/IP: 44818</li> <li>• ModbusTCP: 502</li> <li>• DHCP Server: 67</li> <li>• DHCP Client: 68</li> </ul> UDP Ports: <ul style="list-style-type: none"> <li>• EtherNet/IP: 2222</li> <li>• DHCP Server: 67</li> <li>• DHCP Client: 68</li> </ul> See <a href="#">SOCKADDR_CFG data type</a> on <a href="#">page 598</a> .
Timeout	Input	UDINT	Specify the Timeout for Socket inactivity. If a socket instance does not receive any requests within the specified inactivity timeout, the socket instance is deleted. If a request is sent after the sock instance is deleted an error, Socket instance not supported, is returned. The instruction block returns an error when the timeout value is less than the minimum value. Set Timeout so it is longer than the longest interval between socket operations. If the inactivity Timeout is too short socket instances may timeout. Timeout range: 1000 - 86400000 milliseconds Set <b>Timeout</b> to 0 to use the default value 300000 (5 minutes).
Done	Output	BOOL	Indicates when operation is complete. TRUE - operation completed successfully. FALSE - operation is in progress or encountered an error condition.
Busy	Output	BOOL	TRUE - the operation is incomplete. FALSE - the operation is complete.
Error	Output	BOOL	Indicates an error occurred. TRUE - An error is detected. FALSE - No error.

Parameter	Parameter type	Data type	Description
Status	Output	SOCK_STATUS	Status is defined using the <b>SOCK_STATUS</b> data type which contains ErrorID, SubErrorID, and StatusBits information. See <a href="#">SOCK_STATUS data type</a> on page 598, <a href="#">Socket instruction status bits</a> on page 602, and <a href="#">Socket error codes</a> on page 599.
Instance	Output	UDINT	Contains Socket Handler. Use the Instance parameter for subsequent Socket instructions.

### SOCKET\_CREATE Function Block Diagram example

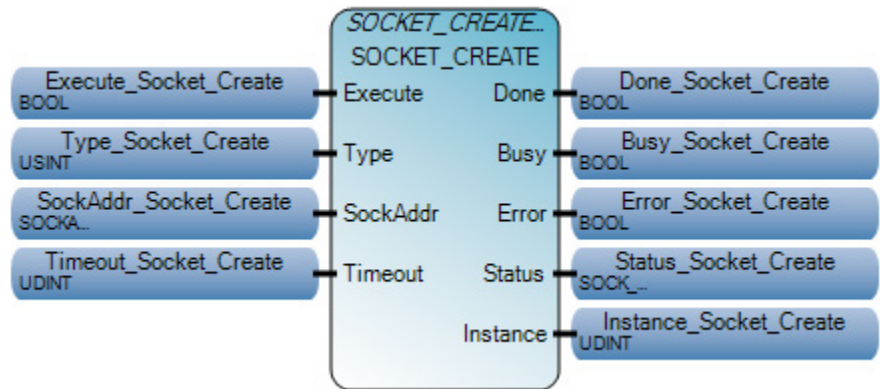

### SOCKET\_CREATE Ladder Diagram example

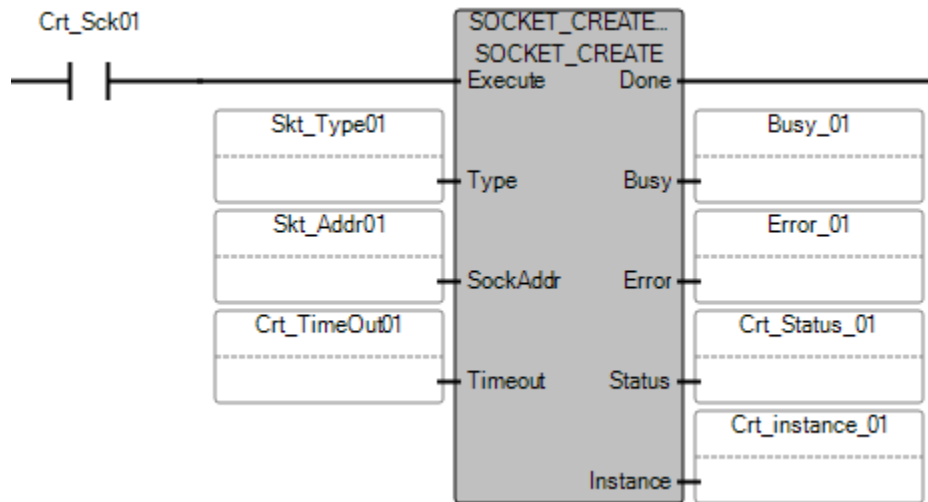

### SOCKET\_CREATE Structured Text example

```

SOCKET_CREATE_1
void SOCKET_CREATE_1(BOOL Execute, USINT Type, SOCKADDR_CFG SockAddr, UDINT Timeout)
Type: SOCKET_CREATE, Create Socket

SOCKET_CREATE_1 (Execute_SOCKET_CREATE, Type_SOCKET_CREATE, Sockaddr_SOCKET_CREATE, Timeout_SOCKET_CREATE);
Done_SOCKET_CREATE := SOCKET_CREATE.Done;
Busy_SOCKET_CREATE := SOCKET_CREATE.Busy;
Error_SOCKET_CREATE := SOCKET_CREATE.Error;
Status_SOCKET_CREATE := SOCKET_CREATE.Status;
Instance_SOCKET_CREATE := SOCKET_CREATE.Instance;
    
```

## Results

### TCP Client example

Name	Alias	Logical Value	Physical Value	Initial Value	Lock	Data Type
Crt_TimeOut01		30000	N/A		<input type="checkbox"/>	UDINT
Crt_Status_01		...	...	...	<input type="checkbox"/>	SOCK_STATUS
Crt_Status_01.ErrorID		0	N/A		<input type="checkbox"/>	USINT
Crt_Status_01.SubErrorID		0	N/A		<input type="checkbox"/>	USINT
Crt_Status_01.StatusBits		17	N/A		<input type="checkbox"/>	USINT
Crt_Skt_Type01		1	N/A	1	<input type="checkbox"/>	USINT
Crt_Skt_Add01		...	...	...	<input type="checkbox"/>	SOCKADDR_CF
Crt_Skt_Add01.Port		0	N/A		<input type="checkbox"/>	UINT
Crt_Skt_Add01.IPAddress		...	...	...	<input type="checkbox"/>	IPADDR
Crt_Skt_Add01.IPAddress[0]		0	N/A		<input type="checkbox"/>	USINT
Crt_Skt_Add01.IPAddress[1]		0	N/A		<input type="checkbox"/>	USINT
Crt_Skt_Add01.IPAddress[2]		0	N/A		<input type="checkbox"/>	USINT
Crt_Skt_Add01.IPAddress[3]		0	N/A		<input type="checkbox"/>	USINT
Crt_Sck01		<input checked="" type="checkbox"/>	N/A		<input type="checkbox"/>	BOOL
Crt_instance_01		1076386296	N/A		<input type="checkbox"/>	UDINT
Crt_Error_01		<input type="checkbox"/>	N/A		<input type="checkbox"/>	BOOL
Crt_Busy_01		<input type="checkbox"/>	N/A		<input type="checkbox"/>	BOOL

### TCP Server example

Name	Alias	Logical Value	Physical Value	Initial Value	Lock	Data Type
Crt_Status_01		...	...	...	<input type="checkbox"/>	SOCK_STATUS
Crt_Status_01.ErrorID		0	N/A		<input type="checkbox"/>	USINT
Crt_Status_01.SubErrorID		0	N/A		<input type="checkbox"/>	USINT
Crt_Status_01.StatusBits		17	N/A		<input type="checkbox"/>	USINT
Crt_Skt_Type01		1	N/A	1	<input type="checkbox"/>	USINT
Crt_Skt_Add01		...	...	...	<input type="checkbox"/>	SOCKADDR_CF
Crt_Skt_Add01.Port		1400	N/A	1400	<input type="checkbox"/>	UINT
Crt_Skt_Add01.IPAddress		...	...	...	<input type="checkbox"/>	IPADDR
Crt_Skt_Add01.IPAddress[0]		0	N/A		<input type="checkbox"/>	USINT
Crt_Skt_Add01.IPAddress[1]		0	N/A		<input type="checkbox"/>	USINT
Crt_Skt_Add01.IPAddress[2]		0	N/A		<input type="checkbox"/>	USINT
Crt_Skt_Add01.IPAddress[3]		0	N/A		<input type="checkbox"/>	USINT
Crt_Sck01		<input checked="" type="checkbox"/>	N/A		<input type="checkbox"/>	BOOL
Crt_instance_01		1076385752	N/A		<input type="checkbox"/>	UDINT
Crt_Error_01		<input type="checkbox"/>	N/A		<input type="checkbox"/>	BOOL
Crt_Busy_01		<input type="checkbox"/>	N/A		<input type="checkbox"/>	BOOL

### UDP example

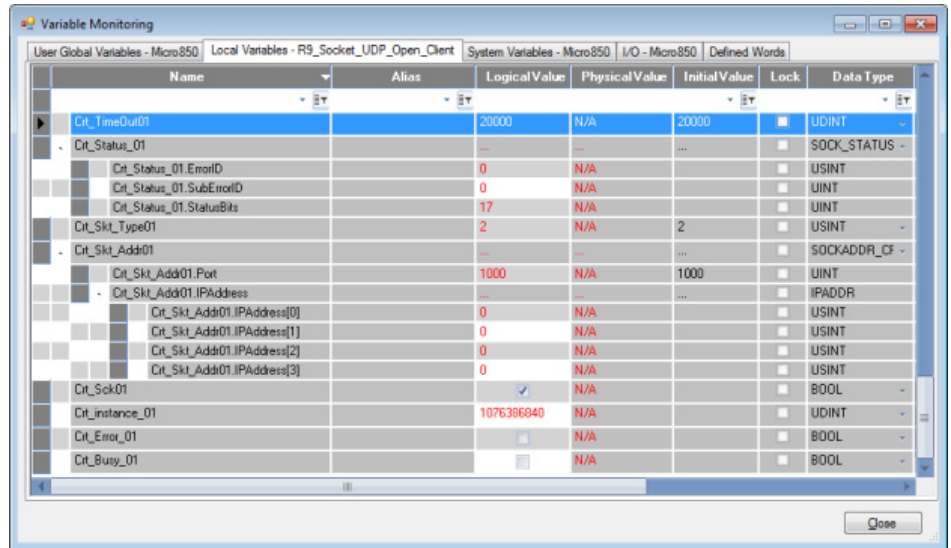

### SOCKET\_DELETE

Deletes a created socket instance. For Transmission Control Protocol (TCP) connections, **SOCKET\_DELETE** also closes (Passive Close) the connection before deleting the instance. Outputs are updated synchronously from the program scan.

Languages supported: Function Block Diagram, Ladder Diagram, Structured Text.

This instruction applies to the Micro820, Micro850, and Micro870 controllers. For the Micro800 Simulator, this instruction can be added to a program but is only a placeholder to prevent the instruction from being deleted during controller change.

The outputs are always reset when the instruction is applied to the simulated controller (2080-LC50-48QWB-SIM).

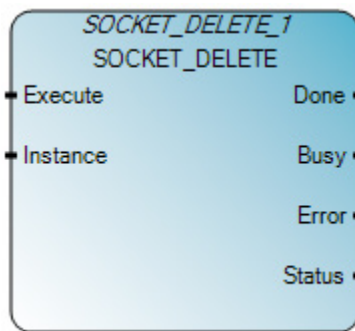

Use this table to help determine the parameter values for this instruction.

Parameter	Parameter type	Data type	Description
Execute	Input	BOOL	Instruction block enable. TRUE - Rising Edge detected, start the instruction block with the precondition that the last operation has been completed. FALSE - no Rising Edge detected.



Parameter	Parameter type	Data type	Description
Instance	Input	UDINT	Copy the returned Socket Handler from a <b>SOCKET_CREATE</b> or <b>SOCKET_ACCEPT</b> instruction to delete the respective socket. <ul style="list-style-type: none"> <li>For UDP and TCP Client Socket types, copy the returned Socket Handler from a <b>SOCKET_CREATE</b> instruction.</li> <li>For TCP Server socket type, copy the returned Socket Handler from a <b>SOCKET_ACCEPT</b> instruction.</li> </ul>
Done	Output	BOOL	Indicates when operation is complete. TRUE - operation completed successfully. FALSE - operation is in progress or encountered an error condition. Output is updated synchronously from the program scan.
Busy	Output	BOOL	TRUE - the operation is not finished. FALSE - the operation is finished. Output is updated synchronously from the program scan.
Error	Output	BOOL	Indicates an error occurred. TRUE - An error is detected. FALSE - No error. Output is updated synchronously from the program scan.
Status	Output	SOCK_STATUS	Status is defined using the <a href="#">SOCK_STATUS data type</a> on <a href="#">page 598</a> which contains <a href="#">ErrorID</a> on <a href="#">page 599</a> , <a href="#">SubErrorID</a> , and <a href="#">StatusBits</a> on <a href="#">page 602</a> information. Output is updated synchronously from the program scan.

### SOCKET\_DELETE Function Block Diagram example

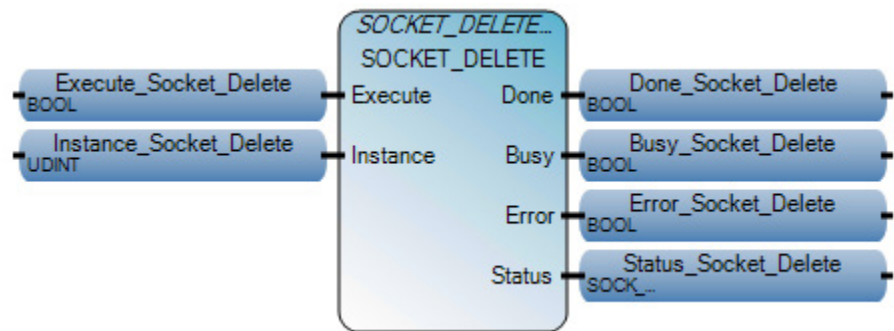

### SOCKET\_DELETE Ladder Diagram example

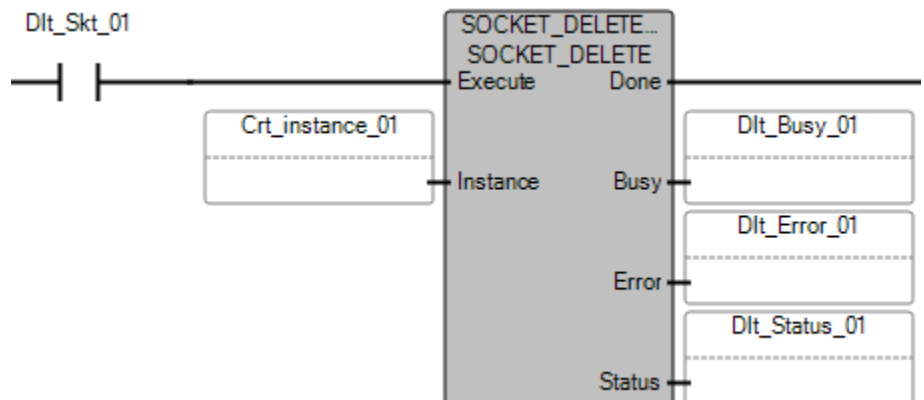

## SOCKET\_DELETE Structured Text example

```
SOCKET_DELETE_1 (
```

```
void SOCKET_DELETE_1(BOOL Execute, UDINT Instance)  
Type : SOCKET_DELETE, Delete Socket
```

```
SOCKET_DELETE_1 (Execute_SOCKET_DELETE, Instance_SOCKET_DELETE);  
Done_SOCKET_DELETE := SOCKET_DELETE.Done;  
Busy_SOCKET_DELETE := SOCKET_DELETE.Busy;  
Error_SOCKET_DELETE := SOCKET_DELETE.Error;  
Status_SOCKET_DELETE := SOCKET_DELETE.Status;
```

## Results

The screenshot shows the Variable Monitoring window with the following data:

Name	Alias	Logical Value	Physical Value	Initial Value	Lock	Data Type
DI_Busy_01		<input type="checkbox"/>	N/A		<input type="checkbox"/>	BOOL
DI_Error_01		<input type="checkbox"/>	N/A		<input type="checkbox"/>	BOOL
DI_Skt_01		<input checked="" type="checkbox"/>	N/A		<input type="checkbox"/>	BOOL
DI_Status_01		---	---	---	<input type="checkbox"/>	SOCK_STAT
DI_Status_01.ErrorID		0	N/A		<input type="checkbox"/>	USINT
DI_Status_01.SubErrorID		0	N/A		<input type="checkbox"/>	UINT
DI_Status_01.StatusBits		17	N/A		<input type="checkbox"/>	UINT

## SOCKET\_DELETEALL

Deletes all created socket instances.

Operation details:

- If the Ethernet cable is disconnected from the controller or the controller IP address changes, you can execute SOCKET\_DELETEALL to delete all previously created socket instances.
- Outputs are updated synchronously from the program scan.

Languages supported: Function Block Diagram, Ladder Diagram, Structured Text.

This instruction applies to the Micro820, Micro850, and Micro870 controllers. For the Micro800 Simulator, this instruction can be added to a program but is only a placeholder to prevent the instruction from being deleted during controller change.

The outputs are always reset when the instruction is applied to the simulated controller (2080-LC50-48QWB-SIM).

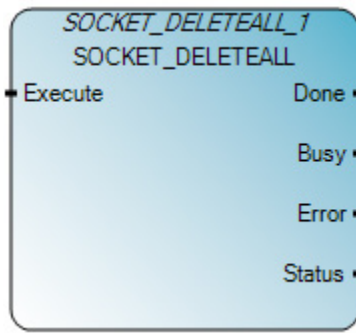

Use this table to help determine the parameter values for this instruction.

Parameter	Parameter type	Data type	Description
Execute	Input	BOOL	Instruction block enable. TRUE - Rising Edge detected, start the instruction block with the precondition that the last operation has been completed. FALSE - no Rising Edge detected.
Done	Output	BOOL	Indicates when operation is complete. TRUE - operation completed successfully. FALSE - operation is in progress or encountered an error condition. Output is updated synchronously from the program scan.
Busy	Output	BOOL	TRUE - the operation is not finished. FALSE - the operation is finished. Output is updated synchronously from the program scan.
Error	Output	BOOL	This field is set to TRUE when the function block execution encounters an error condition. For more information refer to <a href="#">Socket error codes</a> on <a href="#">page 599</a> . Output is updated synchronously from the program scan.
Status	Output	SOCK_STATUS	Status is defined using the <a href="#">SOCK_STATUS data type</a> on <a href="#">page 598</a> which contains <a href="#">ErrorID</a> on <a href="#">page 599</a> , <a href="#">SubErrorID</a> , and <a href="#">StatusBits</a> on <a href="#">page 602</a> information. Output is updated synchronously from the program scan.

### SOCKET\_DELETEALL Function Block Diagram examples

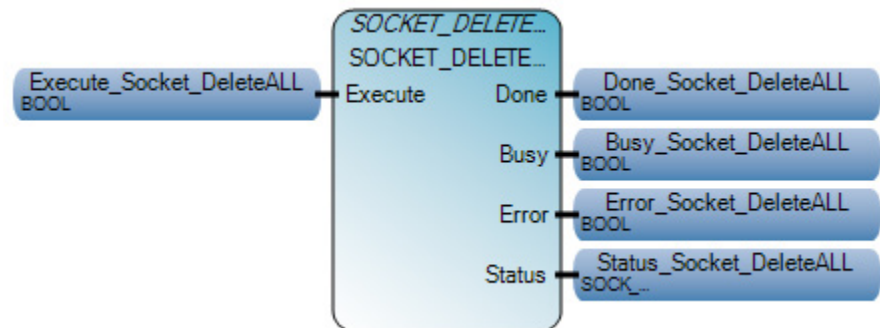

### SOCKET\_DELETEALL Ladder Diagram examples

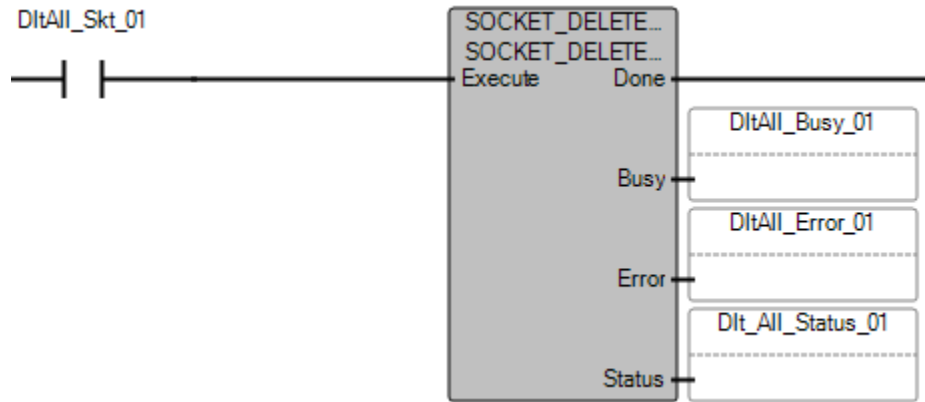

### SOCKET\_DELETEALL Structured Text example

```
SOCKET_DELETEALL_1 (
void SOCKET_DELETEALL_1(BOOL Execute)
Type: SOCKET_DELETEALL, Delete all Socket

SOCKET_DELETEALL (Execute_SOCKET_DELETEALL);
Done_Socket_DeleteAll := SOCKET_DELETE. Done;
Busy_Socket_DeleteAll := SOCKET_DELETE. Busy;
Error_Socket_DeleteAll := SOCKET_DELETE. Error;
Status_Socket_DeleteAll := SOCKET_DELETE. Status;
```

### Results

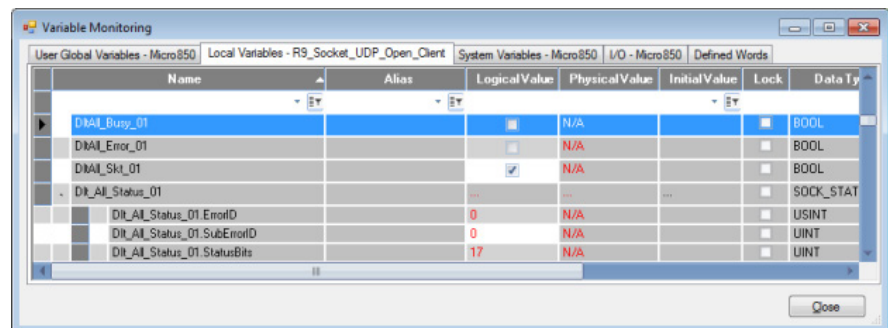

## SOCKET\_INFO

Returns information for a socket instance such as error codes and execution status. Outputs update synchronously from the program scan.

Languages supported: Function Block Diagram, Ladder Diagram, Structured Text.

This instruction applies to the Micro820, Micro850, and Micro870 controllers. For the Micro800 Simulator, this instruction can be added to a program but is only a placeholder to prevent the instruction from being deleted during controller change.

The outputs are always reset when the instruction is applied to the simulated controller (2080-LC50-48QWB-SIM).

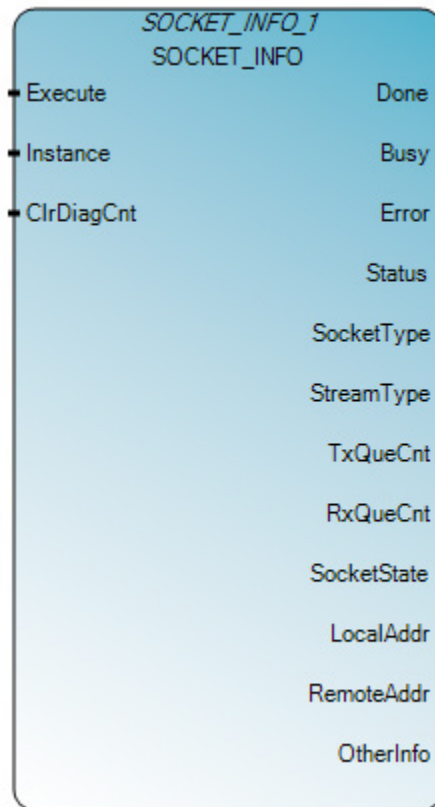

Use this table to help determine the parameter values for this instruction.

Parameter	Parameter type	Data type	Description
Execute	Input	BOOL	Instruction block enable. TRUE - Rising Edge detected, start the instruction block with the precondition that the last operation has been completed. FALSE - no Rising Edge detected.
Instance	Input	UDINT	Copy the returned Socket Handler from a <b>SOCKET_CREATE</b> or <b>SOCKET_ACCEPT</b> instruction to delete the respective socket. <ul style="list-style-type: none"> <li>For UDP and TCP Client Socket types, copy the returned Socket Handler from a <b>SOCKET_CREATE</b> instruction.</li> <li>For TCP Server socket type, copy the returned Socket Handler from a <b>SOCKET_ACCEPT</b> instruction.</li> </ul> When Instance is 0, returns a summary of all Socket Instances.
ClrDiagCnt	Input	BOOL	TRUE - clear Transmission Control Protocol (TCP) or User Datagram Protocol (UDP) Diagnostics counter information. FALSE - no clearing of TCP or UDP counter information. Such as TCP and UDP, <b>OtherInfo</b> Array Index 1 to 6. When Instance is 0, clear <b>OtherInfo</b> Array Index 7 to 14.
Done	Output	BOOL	Indicates when operation is complete. TRUE - operation completed successfully. FALSE - operation is in progress or encountered an error condition. Output is updated synchronously from the program scan.
Busy	Output	BOOL	TRUE - the operation is not finished. FALSE - the operation is finished. Output is updated synchronously from the program scan.

Parameter	Parameter type	Data type	Description
Error	Output	BOOL	Indicates an error occurred. TRUE - An error is detected. FALSE - No error. Output is updated synchronously from the program scan.
Status	Output	SOCK_STATUS	Status is defined using the <a href="#">SOCK_STATUS data type</a> on <a href="#">page 598</a> which contains <a href="#">ErrorID</a> on <a href="#">page 599</a> , <a href="#">SubErrorID</a> , and <a href="#">StatusBits</a> on <a href="#">page 602</a> information. Output is updated synchronously from the program scan.
SocketType	Output	USINT	Socket Instance type: <ul style="list-style-type: none"> <li>• 0 - Not used</li> <li>• 1 - TCP</li> <li>• 2 - UDP</li> </ul> When <b>Socket_Info Instance</b> is 0, <b>SocketType</b> displays as 0.
StreamType	Output	USINT	Socket Stream type: <ul style="list-style-type: none"> <li>• 0 - None</li> <li>• 1 - TCP Server</li> <li>• 2 - TCP Client</li> </ul> When <b>Socket_Info Instance</b> is 0, <b>StreamType</b> displays as 0.
TxQueCnt	Output	USINT	Number of Tx messages currently in the queue. When <b>Socket_Info Instance</b> is 0, <b>TxQueCnt</b> displays as 0.
RxQueCnt	Output	USINT	Number of Rx messages currently in the queue. When <b>Socket_Info Instance</b> is 0, <b>RxQueCnt</b> displays as 0.
SocketState	Output	USINT	Socket Instruction State information. For more information refer to Socket State Machine. When <b>Socket_Info Instance</b> is 0, <b>SocketState</b> displays as 0.
LocalAddr	Output	SOCKETADDR_CFG	Local address for the socket. For more information refer to <a href="#">SOCKETADDR_CFG data type</a> on <a href="#">page 598</a> . When <b>Socket_Info Instance</b> is 0, <b>LocalAddr</b> displays as 0.
RemoteAddr	Output	SOCKETADDR_CFG	Remote address for the socket. For more information refer to <a href="#">SOCKETADDR_CFG data type</a> on <a href="#">page 598</a> . <b>RemoteAddr</b> displays as 0, in the following cases: <ul style="list-style-type: none"> <li>• <b>Socket_Info Instance</b> is 0</li> <li>• User Datagram Protocol (UDP) connections without <b>SOCKET_OPEN</b></li> <li>• UDP with <b>SOCKET_OPEN</b> and disabled <b>RxFilter</b>.</li> </ul>

Parameter	Parameter type	Data type	Description
OtherInfo		UDINT[1..15]	<p>Socket <b>Instance</b> configured as TCP, Array Index Description is:</p> <ul style="list-style-type: none"> <li>• 1 - Packet Sent: Total number of TCP Packets sent on a Socket.</li> <li>• 2 - Bytes Sent: Total number of TCP bytes sent on a Socket.</li> <li>• 3 - Packet Received: Total number of TCP packets received on a Socket.</li> <li>• 4 - Bytes Received: Total number of TCP bytes received on a Socket.</li> <li>• 5 - Retransmit Packets: Total number of TCP packet retransmissions.</li> <li>• 6 - Checksum Errors: Total number of TCP Packets with Checksum errors on a Socket.</li> <li>• 7 - TCP State: Current state of a Socket.</li> <li>• (8 to 11) - OtherInfo is not supported for TCP, displays as 0.</li> <li>• 12 ,13,14,15 - Displays as 0.</li> </ul> <p>Socket Instance configured as UDP, Array Index Description is:</p> <ul style="list-style-type: none"> <li>• 1 - Packet Sent: Total number of UDP packets sent on a Socket.</li> <li>• 2 - Bytes Sent: Total number of UDP bytes sent on a Socket.</li> <li>• 3 - Packet Received: Total number of UDP packets received on a Socket.</li> <li>• 4 - Bytes Received: Total number of UDP bytes received on a Socket.</li> <li>• 5 - Packets Dropped: Total number of UDP received packets dropped for a Socket due to exceeding the maximum queue size limit of 8.</li> <li>• 6 - Checksum Errors: Total number of UDP packets with checksum errors on Socket.</li> <li>• 7 to 15 - Display as 0.</li> </ul> <p>Socket Instance configured as 0, Array Index Description is:</p> <ul style="list-style-type: none"> <li>• 1 - Count for Socket Instance Available. Maximum number of sockets supported.</li> <li>• 2 - Count for Socket Instance Used. Number of sockets created successfully.</li> <li>• 3 - Number of Socket instances created as TCP.</li> <li>• 4 - Number of socket instances created as TCP Client.</li> <li>• 5 - Number of socket instances created as TCP Server.</li> <li>• 6 - Number of Socket instances created as UDP.</li> <li>• 7 - <b>SOCKET_READ</b> Success count when Socket Instance is configured as TCP.</li> <li>• 8 - <b>SOCKET_WRITE</b> Success count when Socket Instance is configured as TCP.</li> <li>• 9 - <b>SOCKET_READ</b> Failure count when Socket Instance is configured as TCP.</li> <li>• 10 - <b>SOCKET_WRITE</b> Failure count when Socket Instance configure as TCP.</li> <li>• 11 - <b>SOCKET_READ</b> Success count when Socket Instance configure as UDP.</li> <li>• 12 - <b>SOCKET_WRITE</b> Success count when Socket Instance configure as UDP.</li> <li>• 13 - <b>SOCKET_READ</b> Failure count when Socket Instance configure as UDP.</li> <li>• 14 - <b>SOCKET_WRITE</b> Failure count when Socket Instance configure as UDP.</li> <li>• 15 - Display as 0.</li> </ul>

### SOCKET\_INFO Function Block Diagram example

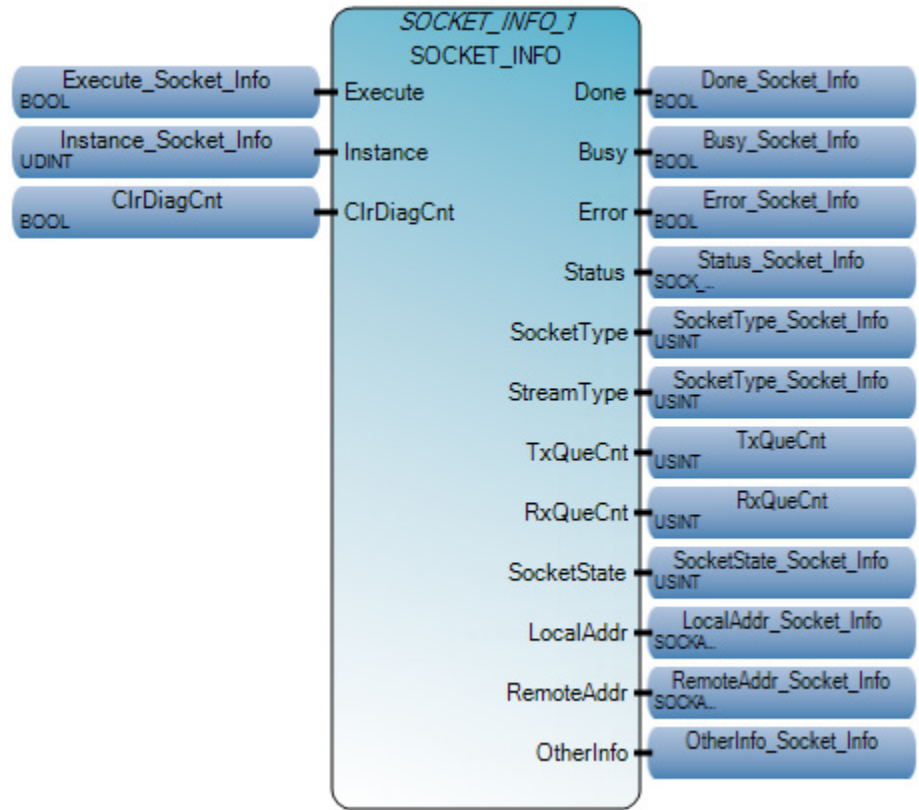



### SOCKET\_INFO Ladder Diagram example

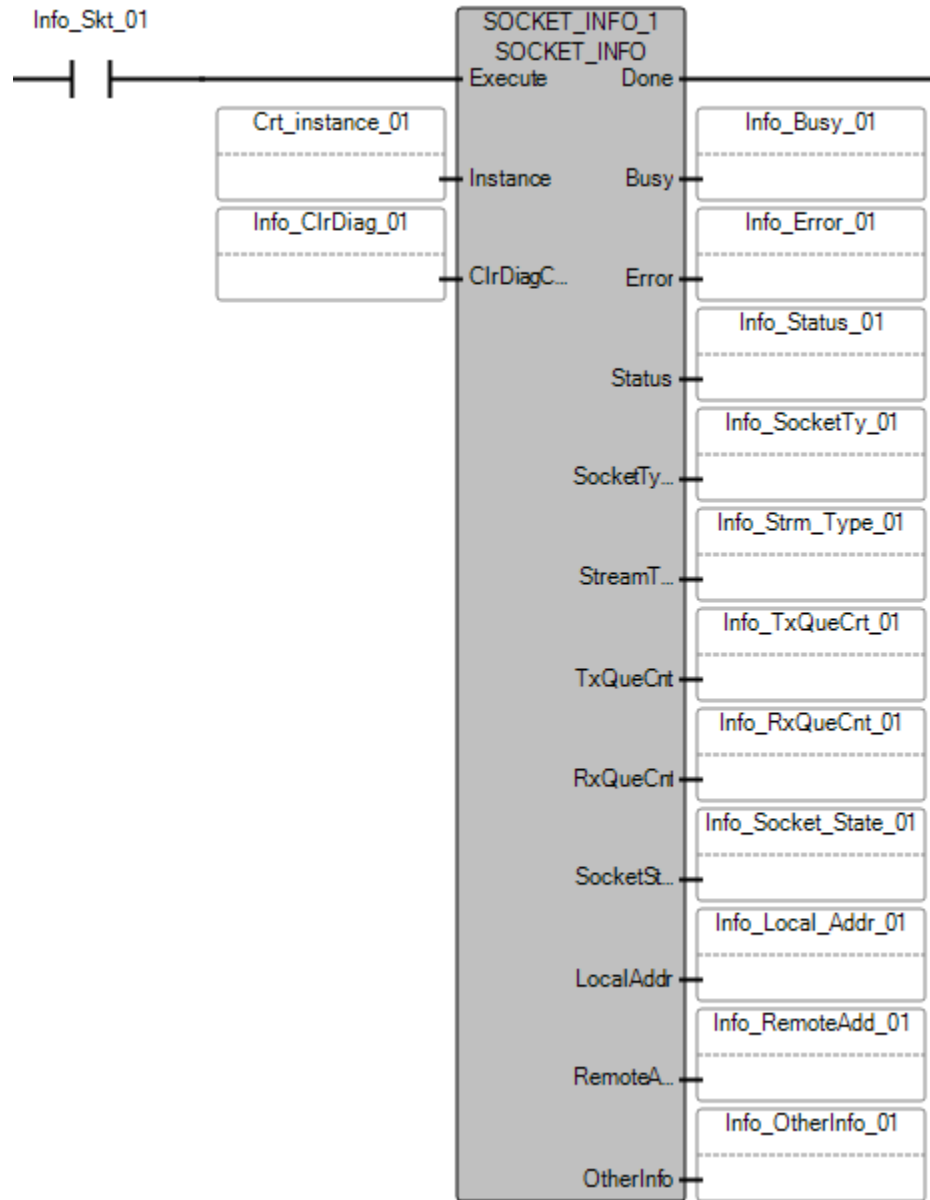

## SOCKET\_INFO Structured Text example

```
SOCKET_INFO_1(
void SOCKET_INFO_1(BOOL Execute, UDINT Instance, BOOL ClrDiagCnt)
Type : SOCKET_INFO, Socket Instance Information
```

```
SOCKET_INFO_1 (Execute_SOCKET_INFO, Instance_SOCKET_INFO, ClrDiagC_SOCKET_INFO);
Done_SOCKET_INFO := SOCKET_INFO. Done;
Busy_SOCKET_INFO := SOCKET_INFO. Busy;
Error_SOCKET_INFO := SOCKET_INFO. Error;
Status_SOCKET_INFO := SOCKET_INFO. Status;
SocketType_SOCKET_INFO := SOCKET_INFO. SocketTy;
StreamType_SOCKET_INFO := SOCKET_INFO. StreamType;
TxQueCnt_SOCKET_INFO := SOCKET_INFO. TxQueCnt;
RxQueCnt_SOCKET_INFO := SOCKET_INFO. RxQueCnt;
SocketState_SOCKET_INFO := SOCKET_INFO. SocketState;
LocalAddr_SOCKET_INFO := SOCKET_INFO. LocalAddr;
RemoteAddr_SOCKET_INFO := SOCKET_INFO. RemoteAddr;
OtherInfo_SOCKET_INFO := SOCKET_INFO. OtherInfo;
```

## Results

The screenshot shows the 'Variable Monitoring' window for 'Local Variables - R9\_Socket\_TCP\_Server'. The table below represents the data shown in the window:

Name	Alias	Logical Value	Physical Value	Initial Value	Lock	Data Type
Info_TxQueCnt_01		0	N/A		<input type="checkbox"/>	USINT
Info_Stm_Type_01		1	N/A		<input type="checkbox"/>	USINT
Info_Status_01		...	...	...	<input type="checkbox"/>	SOCK_STATUS
Info_Socket_State_01		9	N/A		<input type="checkbox"/>	USINT
Info_SocketTy_01		1	N/A		<input type="checkbox"/>	USINT
Info_Skt_01			N/A		<input type="checkbox"/>	BOOL
Info_RxQueCnt_01		0	N/A		<input type="checkbox"/>	USINT
Info_RemoteAddr_01		...	...	...	<input type="checkbox"/>	SOCKADDR_CF
Info_OtherInfo_01		...	...	...	<input type="checkbox"/>	UDINT
Info_Local_Addr_01		...	...	...	<input type="checkbox"/>	SOCKADDR_CF
Info_Error_01			N/A		<input type="checkbox"/>	BOOL
Info_ClrDiag_01			N/A		<input type="checkbox"/>	BOOL
Info_Busy_01			N/A		<input type="checkbox"/>	BOOL

## SOCKET\_OPEN

Opens the connection for the specified destination address for Transmission Control Protocol (TCP) connections. For User Datagram Protocol (UDP) connections, associates a destination IP address and port number with the specified socket.

Operations details:

- For User Datagram Protocol (UDP) connections using **SOCKET\_OPEN** the IP address and port number are not required each time data is sent.
- For UDP connections not using **SOCKET\_OPEN**, the destination address must be specified each time **SOCKET\_WRITE** is used to send data.
- When using **SOCKET\_READ**, in addition to receiving data, the address of the sender is returned. The senders address can be used to send a response using **SOCKET\_WRITE**.
- A **SOCKET\_OPEN** operation might return before the timeout period without creating a Transmission Control Protocol (TCP) connection.

This might occur if the destination device is running but is not listening for connections on the specified port number, **SOCKET\_OPEN** returns with an error before the timeout period.

- Outputs update synchronously from the program scan.

Languages supported: Function Block Diagram, Ladder Diagram, Structured Text.

This instruction applies to the Micro820, Micro850, and Micro870 controllers. For the Micro800 Simulator, this instruction can be added to a program but is only a placeholder to prevent the instruction from being deleted during controller change.

The outputs are always reset when the instruction is applied to the simulated controller (2080-LC50-48QWB-SIM).

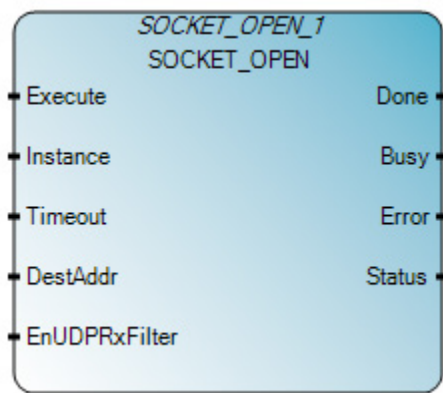

Use this table to help determine the parameter values for this instruction.

Parameter	Parameter type	Data type	Description
Execute	Input	BOOL	Instruction block enable. TRUE - Rising Edge detected, start the instruction block with the precondition that the last operation has been completed. FALSE - no Rising Edge detected.
Instance	Input	UDINT	Copy from the returned Socket Handler from a <b>SOCKET_CREATE</b> function block.
Timeout	Input	UDINT	Timeout for SOCKET_OPEN function block. The function block returns an Error if the Timeout value is less than the minimum value.  Timeout range: 1000 - 1800000 milliseconds Set Timeout to 0 to use the default value 10000 (10 Second).

Parameter	Parameter type	Data type	Description
DestAddr	Input	<a href="#">SOCKADDR_CFG</a> on <a href="#">page 598</a>	<p>The address of the destination connection.</p> <p>A connection between the IP address and the port number of remote host is required.</p> <p>The following IP Addresses are not supported for DestAddr:</p> <ul style="list-style-type: none"> <li>• Self IP Address</li> <li>• Loop back address</li> <li>• 0.0.0.0</li> <li>• Broadcast address (Only supported for TCP), exception addresses: <ul style="list-style-type: none"> <li>• Class D multicast address (224.x.x.x)</li> <li>• Local link address (169.254.x.x)</li> </ul> </li> </ul> <p>Example for IP Address of 192.168.2.100 and Port 12000:</p> <ul style="list-style-type: none"> <li>• DestAddr.IPAddress[0]=192</li> <li>• DestAddr.IPAddress[1]=168</li> <li>• DestAddr.IPAddress[2]=2</li> <li>• DestAddr.IPAddress[3]=100</li> <li>• DestAddr.Port = 12000</li> </ul>
EnUDPRxFilter	Input	BOOL	<p>For UDP socket, when SOCKET_OPEN and Enable EnUDPRxFilter are used, a packet filter for specific IP Address and port number is not needed each time to read data.</p> <ul style="list-style-type: none"> <li>• A UDP socket with open is created. DestAddr as IP 192.168.1.157 / Port 161. EnUDPRxFilter Enable, perform Socket_Read.</li> <li>• When controller receive data from DestAddr (192.168.1.157 / 161), Socket_Read completes the operation successfully. If controller receives data from any other IP or Port then socket_Read ignores that packet and waits for DestAddr Packet.</li> </ul> <p>EnUDPRxFilter Disabled:</p> <ul style="list-style-type: none"> <li>• Perform SOCKET_READ. The controller receives any data on configure UDP port, SOCKET_READ completes operation successfully.</li> <li>• The application checks whether the incoming packet arrives from the expected device or not.</li> <li>• The application handles filtering based on the SOCKET_READ output parameter UDPAddr.</li> </ul>
Done	Output	BOOL	<p>Indicates when operation is complete.</p> <p>TRUE - operation completed successfully.</p> <p>FALSE - operation is in progress or encountered an error condition.</p> <p>Output is updated synchronously from the program scan.</p>
Busy	Output	BOOL	<p>TRUE - the operation is not finished.</p> <p>FALSE - the operation is finished.</p> <p>Output is updated synchronously from the program scan.</p>
Error	Output	BOOL	<p>Indicates an error occurred.</p> <p>TRUE - An error is detected.</p> <p>FALSE - No error.</p> <p>Output is updated synchronously from the program scan.</p>
Status	Output	SOCK_STATUS	<p>Status is defined using the <a href="#">SOCK_STATUS data type</a> on <a href="#">page 598</a> which contains <a href="#">ErrorID</a> on <a href="#">page 599</a>, SubErrorID, and <a href="#">StatusBits</a> on <a href="#">page 602</a> information.</p> <p>Output is updated synchronously from the program scan.</p>

### SOCKET\_OPEN Function Block Diagram example

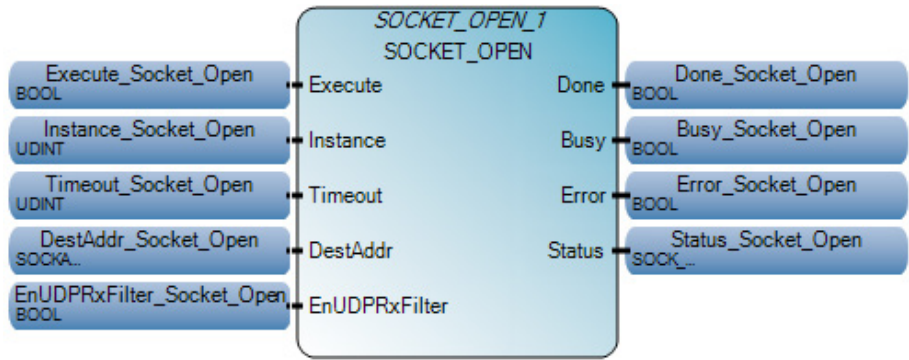

### SOCKET\_OPEN Ladder Diagram example

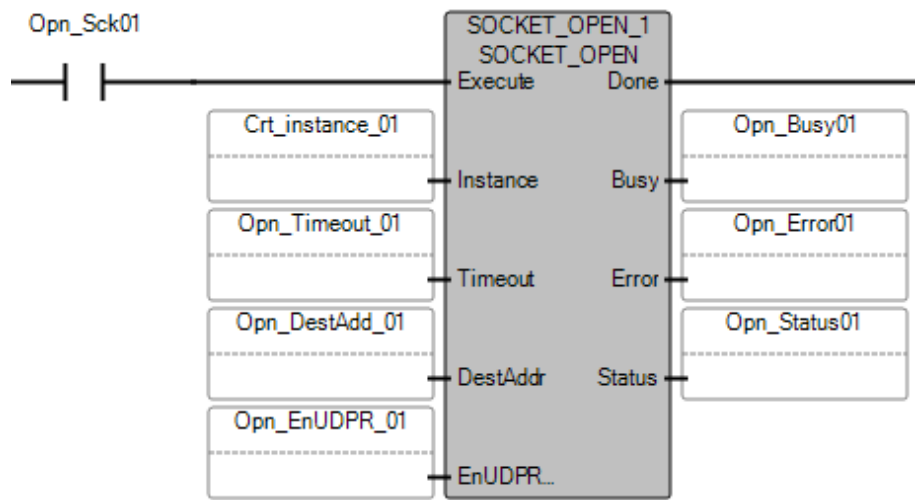

### SOCKET\_OPEN Structured Text example

```

SOCKET_OPEN_1
void SOCKET_OPEN_1(BOOL Execute, UDINT Instance, UDINT Timeout, SOCKADDR_CFG DestAddr, BOOL EnUDPRxFilter)
Type: SOCKET_OPEN, Open Socket

SOCKET_OPEN_1 (Execute_SOCKET_OPEN, Instance_SOCKET_OPEN, Timeout_SOCKET_OPEN, BestAddr_SOCKET_OPEN, EnVDPR_SOCKET_OPEN)
Done_SOCKET_OPEN := _SOCKET_OPEN. Done:
Busy_SOCKET_OPEN := _SOCKET_OPEN. Busy:
Error_SOCKET_OPEN := _SOCKET_OPEN. Error:
Status_SOCKET_OPEN := _SOCKET_OPEN. Status:
    
```

## Results

### TCP example

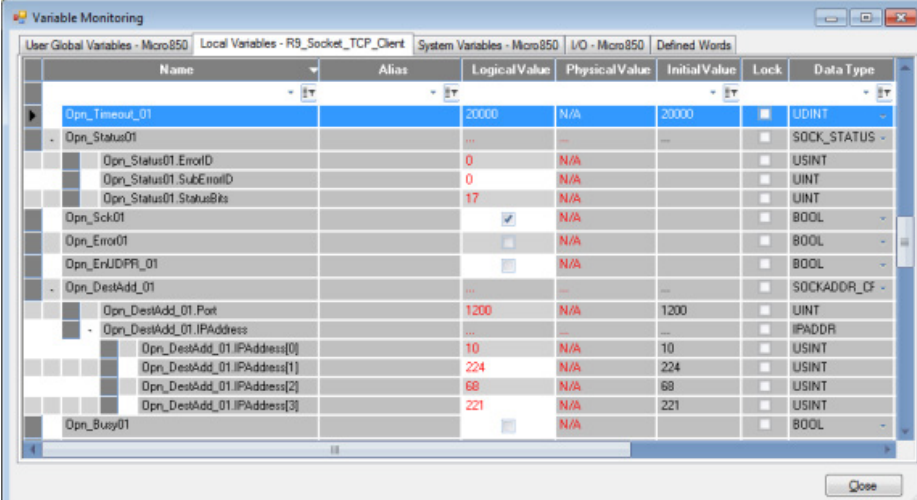

Name	Alias	Logical Value	Physical Value	Initial Value	Lock	Data Type
Opn_Timeout_01		20000	N/A	20000		UDINT
Opn_Status01		...	...	...		SOCK_STATUS
Opn_Status01.ErrorID		0	N/A	...		USINT
Opn_Status01.SubErrorID		0	N/A	...		UINT
Opn_Status01.StatusBks		17	N/A	...		UINT
Opn_Sck01			N/A	...	<input checked="" type="checkbox"/>	BOOL
Opn_Error01			N/A	...	<input type="checkbox"/>	BOOL
Opn_ErrUDPF01			N/A	...	<input type="checkbox"/>	BOOL
Opn_DestAdd_01		...	...	...		SOCKADDR_CF
Opn_DestAdd_01.Port		1200	N/A	1200		UINT
Opn_DestAdd_01.IPAddress		...	...	...		IPADDR
Opn_DestAdd_01.IPAddress[0]		10	N/A	10		USINT
Opn_DestAdd_01.IPAddress[1]		224	N/A	224		USINT
Opn_DestAdd_01.IPAddress[2]		68	N/A	68		USINT
Opn_DestAdd_01.IPAddress[3]		221	N/A	221		USINT
Opn_Busy01			N/A	...	<input type="checkbox"/>	BOOL

### UDP example

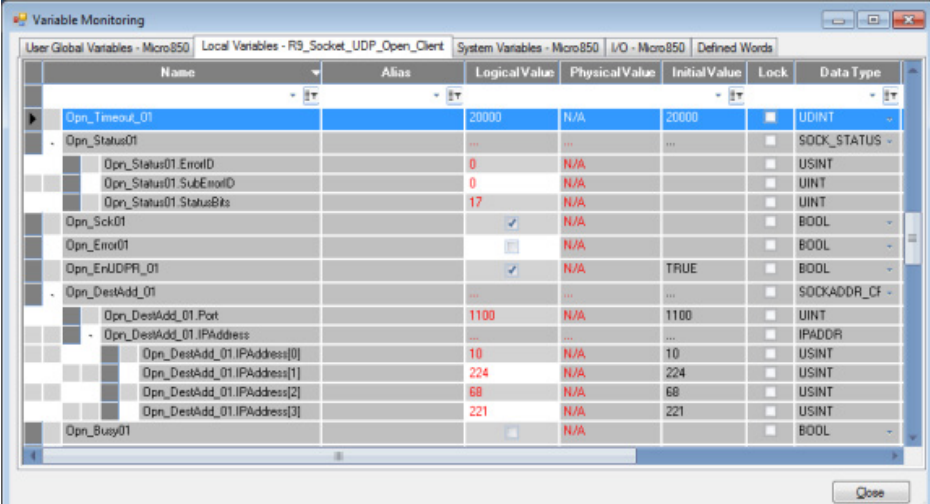

Name	Alias	Logical Value	Physical Value	Initial Value	Lock	Data Type
Opn_Timeout_01		20000	N/A	20000		UDINT
Opn_Status01		...	...	...		SOCK_STATUS
Opn_Status01.ErrorID		0	N/A	...		USINT
Opn_Status01.SubErrorID		0	N/A	...		UINT
Opn_Status01.StatusBks		17	N/A	...		UINT
Opn_Sck01			N/A	...	<input checked="" type="checkbox"/>	BOOL
Opn_Error01			N/A	...	<input type="checkbox"/>	BOOL
Opn_ErrUDPF01			N/A	TRUE		BOOL
Opn_DestAdd_01		...	...	...		SOCKADDR_CF
Opn_DestAdd_01.Port		1100	N/A	1100		UINT
Opn_DestAdd_01.IPAddress		...	...	...		IPADDR
Opn_DestAdd_01.IPAddress[0]		10	N/A	10		USINT
Opn_DestAdd_01.IPAddress[1]		224	N/A	224		USINT
Opn_DestAdd_01.IPAddress[2]		68	N/A	68		USINT
Opn_DestAdd_01.IPAddress[3]		221	N/A	221		USINT
Opn_Busy01			N/A	...	<input type="checkbox"/>	BOOL

## SOCKET\_READ

Reads data on a socket and returns the specified number of bytes. For Transmission Control Protocol (TCP), returns when any data is received, up to the requested number of bytes. For User Datagram Protocol (UDP), completes when a datagram is available.

Operation details:

The following **SOCKET\_READ** behavior might impact existing communications including non-socket communication.

- If the **SOCKET\_READ** operation is not executed in sync with the remote device then, the controller holds the remote device receive packet until one of the following occurs:
  - **SOCKET\_READ** is executed.
  - Socket Timeout expires.
  - RST is received from a remote device.

- **SOCKET\_DELETE** or **SOCKET\_DELETEALL** is executed.
- User performs a **Run Mode Change** which deletes all created Socket instances.
- Controller changes from run mode to program mode which deletes all created Socket instances.
- Controller changes from run mode to program mode which clears socket Diagnostic counter information and individual Socket counter information.
- If the Length or Offset parameter value is changed while the **SOCKET\_READ** operation is ongoing (BUSY = True) an error occurs and the receive packet is discarded.
- The **SOCKET\_READ** instruction might return fewer bytes than were requested. RxLength contains the number of bytes of data received. Write programs to check RxLength and then issue additional read requests to receive an entire application message.
- In **Run Mode Change** mode, changing a **SOCKET\_READ** input while operating in the BUSY state results in an error and the received packet is discarded.
- Outputs update synchronously from the program scan.

Languages supported: Function Block Diagram, Ladder Diagram, Structured Text.

This instruction applies to the Micro820, Micro850, and Micro870 controllers. For the Micro800 Simulator, this instruction can be added to a program but is only a placeholder to prevent the instruction from being deleted during controller change.

The outputs are always reset when the instruction is applied to the simulated controller (2080-LC50-48QWB-SIM).



Use this table to help determine the parameter values for this instruction.

Parameter	Parameter type	Data type	Description
Execute	Input	BOOL	Instruction enable. TRUE - Rising Edge detected, start the instruction with the precondition that the last operation is complete. FALSE - do not start instruction.

Parameter	Parameter type	Data type	Description
Instance	Input	UDINT	Copy from the returned Socket Handler from a <b>SOCKET_CREATE</b> or <b>SOCKET_ACCEPT</b> instruction. <ul style="list-style-type: none"> <li>For UDP and TCP Client Socket types, copy the returned Socket Handler from a <b>SOCKET_CREATE</b> instruction.</li> <li>For TCP Server Socket type, copy the returned Socket Handler from a <b>SOCKET_ACCEPT</b> instruction.</li> </ul>
Timeout	Input	UDINT	Timeout for <b>SOCKET_READ</b> . The instruction block returns an Error if the timeout value is less than the minimum value. Timeout range: 1000- 86400000 milliseconds Set <b>Timeout</b> to 0 to use the default value 10000 (10 Second).
Length	Input	UINT	Defines the number of bytes to read. Check <b>RxLength</b> for the actual number of bytes read. <b>SOCKET_READ</b> can return fewer bytes than requested. Supports up to 256 bytes.
Offset	Input	UNIT	Offset into array of <b>Data</b> . Start reading data read from this location.
Data	Output	USINT[1..1]	An Array used to store the data read from <b>SOCKET_READ</b> . <ul style="list-style-type: none"> <li>Data array size must be <math>\geq</math> (<b>Offset</b> + <b>Length</b>).</li> <li>Data array can be bigger than socket read Length.</li> </ul> Output is updated synchronously from the program scan.
Done	Output	BOOL	Indicates when operation is complete. TRUE - operation completed successfully. FALSE - operation is in progress or encountered an error condition. Output is updated synchronously from the program scan.
Busy	Output	BOOL	TRUE - the operation is not finished. FALSE - the operation is finished. Output is updated synchronously from the program scan.
Error	Output	BOOL	Indicates an error occurred. TRUE - An error is detected. FALSE - No error. Output is updated synchronously from the program scan.
Status	Output	SOCK_STATUS	Status is defined using the <a href="#">SOCK_STATUS data type</a> on <a href="#">page 598</a> which contains <a href="#">ErrorID</a> on <a href="#">page 599</a> , <a href="#">SubErrorID</a> , and <a href="#">StatusBits</a> on <a href="#">page 602</a> information. Output is updated synchronously from the program scan.
RxLength	Output	UNIT	Contains the number of data bytes received.
UDPAddr	Output	<a href="#">SOCKADDR_CFG</a> on <a href="#">page 598</a>	The address of the device sending User Datagram Protocol (UDP) data.  Example defines a UDPAddr of 192.168.2.100 and Port 12000: <pre> UDPAddr.IPAddress[0]=192 UDPAddr.IPAddress[1]=168 UDPAddr.IPAddress[2]=2 UDPAddr.IPAddress[3]=100 UDPAddr.Port = 12000 </pre> For Transmission Control Protocol (TCP), this structure is not used and contain all zeros. The TCP connection conveys the remote address information.



### SOCKET\_READ Function Block Diagram example

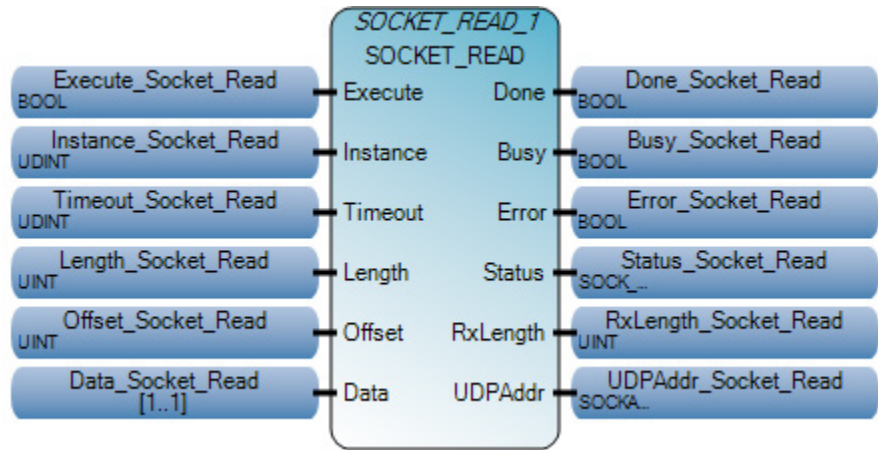

### SOCKET\_READ Ladder Diagram example

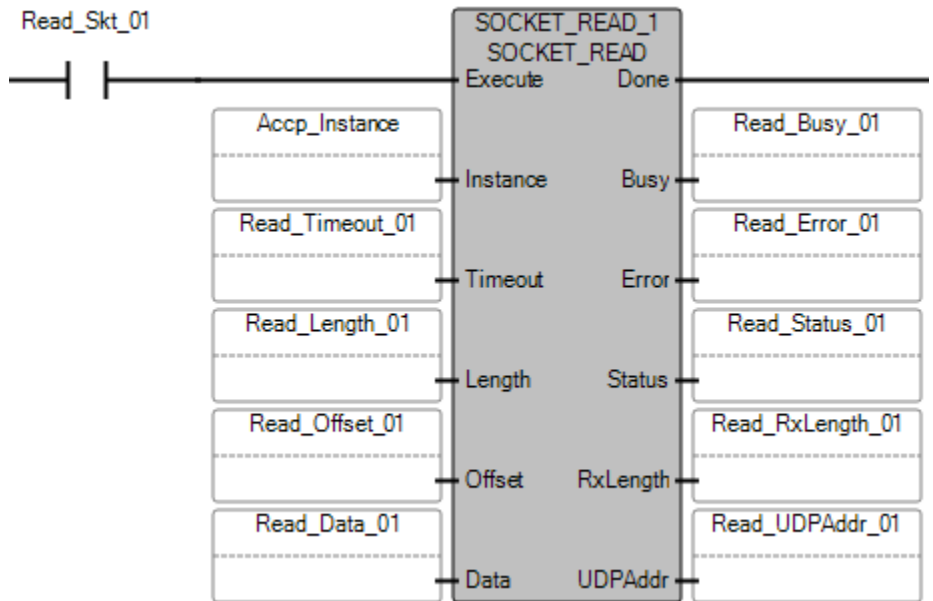

### SOCKET\_READ Structured Text example

```

SOCKET_READ_1
void SOCKET_READ_1(BOOL Execute, UDINT Instance, UDINT Timeout, UINT Length, UINT Offset, USINT[1..1] Data)
Type: SOCKET_READ, Read Socket

SOCKET_READ_1 (Execute_SOCKET_READ, Instance_SOCKET_READ, Timeout_SOCKET_READ, Length_SOCKET_READ, Offset_SOCKET_READ, Data_SOCKET_READ)
Done_SOCKET_READ := SOCKET_READ.Done;
Busy_SOCKET_READ := SOCKET_READ.Busy;
Error_SOCKET_READ := SOCKET_READ.Error;
Status_SOCKET_READ := SOCKET_READ.Status;
RxLength_SOCKET_READ := SOCKET_READ.RxLength;
UDPAddr_SOCKET_READ := SOCKET_READ.UDPAddr;
    
```

## Results

TCP example:

Name	Alias	Logical Value	Physical Value	Initial Value	Lock	Data Type
Read_Busy_01			N/A			BOOL
Read_Error_01			N/A			BOOL
Read_Length_01		256	N/A	256		UINT
Read_Offset_01		0	N/A			UINT
Read_RxLength_01		256	N/A			UINT
Read_Status_01		...	...	...		SOCK_STATUS
Read_Status_01_ErrorID		0	N/A			USINT
Read_Status_01_SubErrorID		0	N/A			UINT
Read_Status_01_StatusBits		16	N/A			UINT
Read_Timeout_01		20000	N/A	20000		UDINT
Read_UDPAAddr_01		...	...	...		SOCKADDR_CF
Read_UDPAAddr_01_Port		0	N/A			UINT
Read_UDPAAddr_01_IPAddress		...	...	...		IPADDR
Read_UDPAAddr_01_IPAddress[0]		0	N/A			USINT
Read_UDPAAddr_01_IPAddress[1]		0	N/A			USINT
Read_UDPAAddr_01_IPAddress[2]		0	N/A			USINT
Read_UDPAAddr_01_IPAddress[3]		0	N/A			USINT

UDP example:

Name	Alias	Logical Value	Physical Value	Initial Value	Lock	Data Type
Read_Busy_01			N/A			BOOL
Read_Error_01			N/A			BOOL
Read_Length_01		256	N/A	256		UINT
Read_Offset_01		0	N/A			UINT
Read_RxLength_01		256	N/A			UINT
Read_Status_01		...	...	...		SOCK_STATUS
Read_Status_01_ErrorID		0	N/A			USINT
Read_Status_01_SubErrorID		0	N/A			UINT
Read_Status_01_StatusBits		17	N/A			UINT
Read_Timeout_01		3000	N/A	3000		UDINT
Read_UDPAAddr_01		...	...	...		SOCKADDR_CF
Read_UDPAAddr_01_Port		1000	N/A			UINT
Read_UDPAAddr_01_IPAddress		...	...	...		IPADDR
Read_UDPAAddr_01_IPAddress[0]		10	N/A			USINT
Read_UDPAAddr_01_IPAddress[1]		224	N/A			USINT
Read_UDPAAddr_01_IPAddress[2]		68	N/A			USINT
Read_UDPAAddr_01_IPAddress[3]		219	N/A			USINT

## SOCKET\_WRITE

Sends data on a socket.

Operation details:

- **SOCKET\_WRITE** attempts to send the requested number of data bytes specified in the Length parameter. When the send operation completes **SOCKET\_WRITE** returns the number of data bytes written to the TxLength parameter.
- Output is updated asynchronously from the program scan.

Languages supported: Function Block Diagram, Ladder Diagram, Structured Text.

This instruction applies to the Micro820, Micro850, and Micro870 controllers. For the Micro800 Simulator, this instruction can be added to a program but is

only a placeholder to prevent the instruction from being deleted during controller change.

The outputs are always reset when the instruction is applied to the simulated controller (2080-LC50-48QWB-SIM).

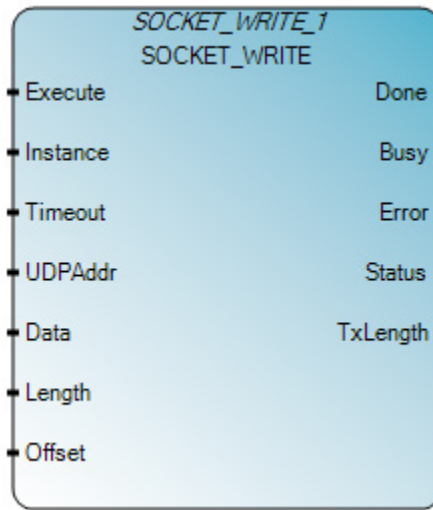

Use this table to help determine the parameter values for this instruction.

Parameter	Parameter type	Data type	Description
Execute	Input	BOOL	Instruction block enable. TRUE - Rising Edge detected, start the instruction block with the precondition that the last operation has been completed. FALSE - no Rising Edge detected.
Instance	Input	UDINT	Copy the returned Socket Handler from a <b>SOCKET_CREATE</b> or <b>SOCKET_ACCEPT</b> instruction. <ul style="list-style-type: none"> <li>For UDP and TCP-Client Socket types, copy the returned Socket Handler from a <b>SOCKET_CREATE</b> instruction.</li> <li>For TCP- Server socket type, copy from returned Socket Handler from a <b>SOCKET_ACCEPT</b> instruction.</li> </ul>
Timeout	Input	UDINT	Timeout for <b>SOCKET_WRITE</b> instances. The instruction returns an Error if the Timeout value is less than minimum value. Timeout range: 1000 to 1800000 milliseconds Set Timeout to 0 to use the default value 10000 (10 Second).
UDPAddr	Input	<a href="#">SOCKADDR_CFG</a> on <a href="#">page 598</a>	The UDP destination address that the data is being written to when a <b>SOCKET_OPEN</b> instruction has not been executed since creating the socket. For TCP, or when the <b>SOCKET_OPEN</b> instruction has been executed for UDP, this structure is not used and should contain all zeros. The TCP connection and the <b>SOCKET_OPEN</b> instruction for UDP convey all of the remote address information. Example for a UDPAddr of 192.168.2.100 and Port 12000: UDPAddr.IPAddress[0]=192 UDPAddr.IPAddress[1]=168 UDPAddr.IPAddress[2]=2 UDPAddr.IPAddress[3]=100 UDPAddr.Port = 12000 Use the <b>SOCKADDR_CFG</b> data type to define UDPAddr.
Data	Input	USINT[1..1]	An Array used to store the data write to respective socket instance using the <b>SOCKET_WRITE</b> Instruction. <ul style="list-style-type: none"> <li>Data array size must be <math>\geq</math> (<b>Offset + Length</b>).</li> <li>Data array can be bigger than <b>SOCKET_WRITE</b> Length.</li> </ul>

Parameter	Parameter type	Data type	Description
Length	Input	UINT	The number of bytes of data to write. Maximum is 256 bytes.
Offset	Input	UNIT	Offset into array of Data. The data write from the SOCKET_WRITE is starting from this location.
Done	Output	BOOL	Indicates when operation is complete. TRUE - operation completed successfully. FALSE - operation is in progress or encountered an error condition. Output is updated synchronously from the program scan.
Busy	Output	BOOL	TRUE - the operation is not finished. FALSE - the operation is finished. Output is updated synchronously from the program scan.
Error	Output	BOOL	Indicates an error occurred. TRUE - An error is detected. FALSE - No error. Output is updated synchronously from the program scan.
Status	Output	SOCK_STATUS	Status is defined using the <a href="#">SOCK_STATUS data type</a> on <a href="#">page 598</a> which contains <a href="#">ErrorID</a> on <a href="#">page 599</a> , <a href="#">SubErrorID</a> , and <a href="#">StatusBits</a> on <a href="#">page 602</a> information. Output is updated synchronously from the program scan.
TxLength	Output	UNIT	The number of bytes of written data.

### SOCKET\_WRITE Function Block Diagram example

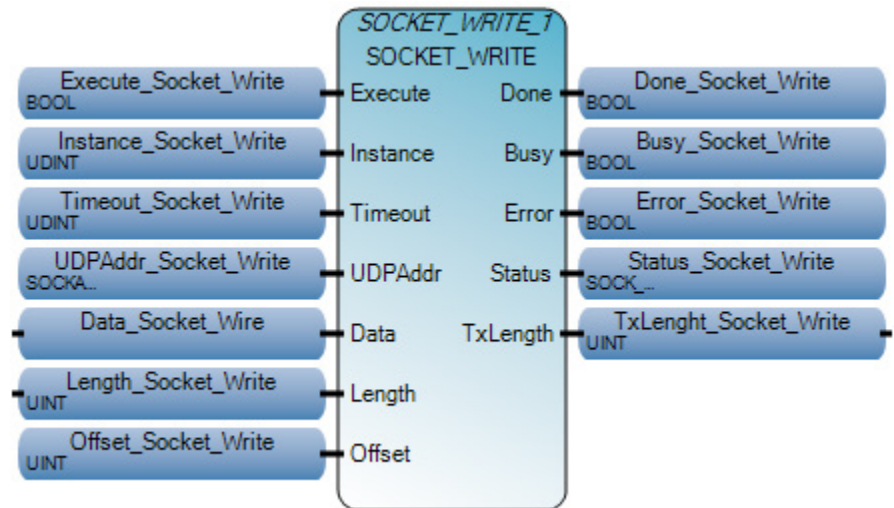

### SOCKET\_WRITE Ladder Diagram example

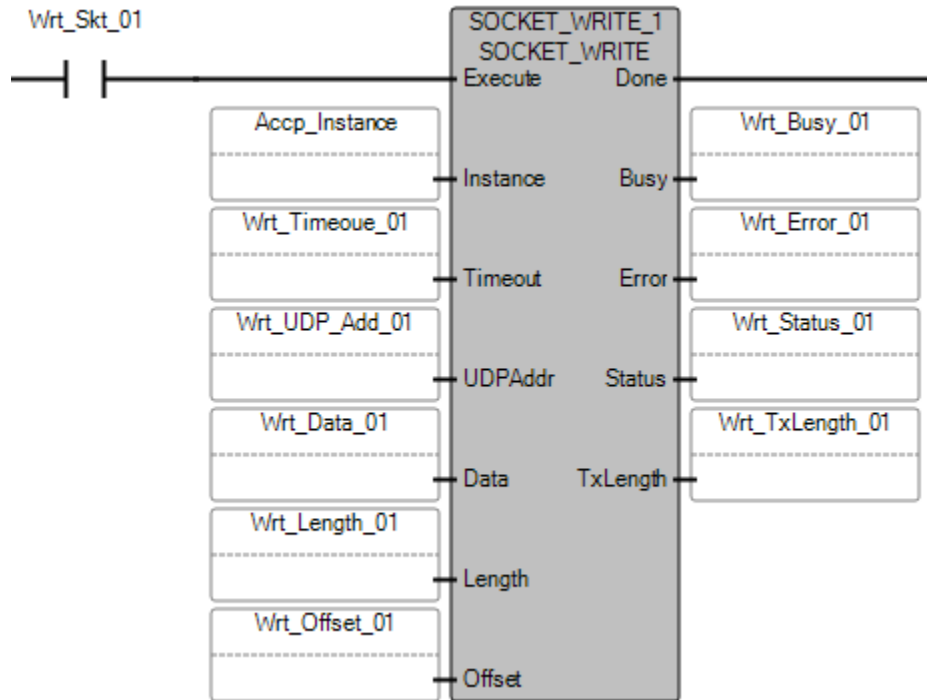

### SOCKET\_WRITE Structured Text example

```

SOCKET_WRITE_1
void SOCKET_WRITE_1(BOOL Execute, UDINT Instance, UDINT Timeout, SOCKADDR_CFG UDPAddr, USINT[1..1] Data, UINT Length, UINT Offset)
Type: SOCKET_WRITE, Write Socket

SOCKET_WRITE_1(Execute_SOCKET_WRITE, Instance_SOCKET_WRITE, Timeout_SOCKET_WRITE, UDPAddr_SOCKET_WRITE, Length_SOCKET_WRITE, Offset_SOCKET_WRITE)
Done_SOCKET_WRITE := SOCKET_WRITE.Done;
Busy_SOCKET_WRITE := SOCKET_WRITE.Busy;
Error_SOCKET_WRITE := SOCKET_WRITE.Error;
Status_SOCKET_WRITE := SOCKET_WRITE.Status;
TxLength_SOCKET_WRITE := SOCKET_WRITE.TxLength;
    
```

### Results

TCP example:

Name	Alias	Logical Value	Physical Value	Initial Value	Lock	Data Type
Wrt_Busy_01			N/A			BOOL
Wrt_Error_01			N/A			BOOL
Wrt_Length_01		256	N/A	256		UINT
Wrt_Offset_01		0	N/A			UINT
Wrt_Status_01						SOCK_STATUS
Wrt_Status_01.ErrorID		0	N/A			USINT
Wrt_Status_01.SubErrorID		0	N/A			USINT
Wrt_Status_01.StatusBits		17	N/A			UINT
Wrt_Timeout_01		20000	N/A	20000		UDINT
Wrt_TxLength_01		256	N/A			UINT
Wrt_UDP_Add_01						SOCKADDR_CFG
Wrt_UDP_Add_01.Port		0	N/A			UINT
Wrt_UDP_Add_01.IPAddress						IPADDR
Wrt_UDP_Add_01.IPAddress[0]		0	N/A			USINT
Wrt_UDP_Add_01.IPAddress[1]		0	N/A			USINT
Wrt_UDP_Add_01.IPAddress[2]		0	N/A			USINT
Wrt_UDP_Add_01.IPAddress[3]		0	N/A			USINT

UDP without open example:

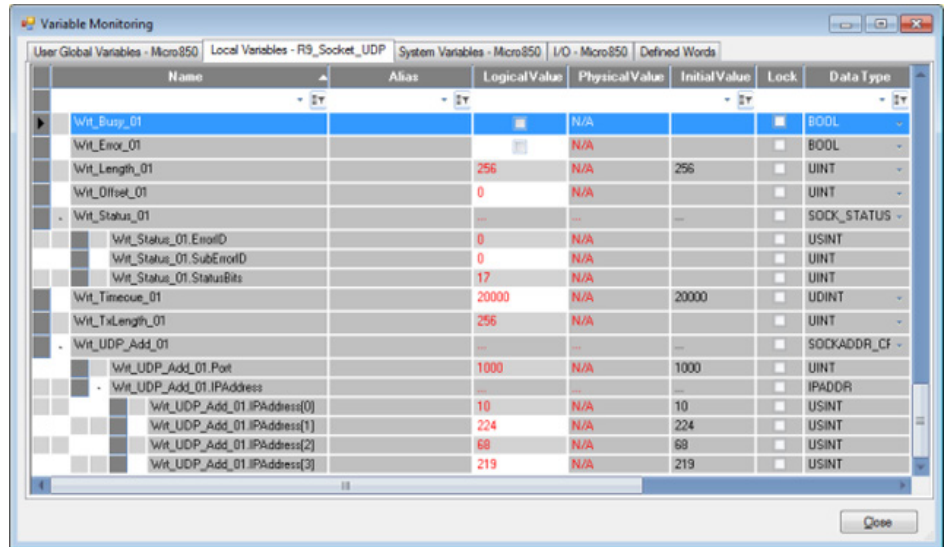

UDP with open example:

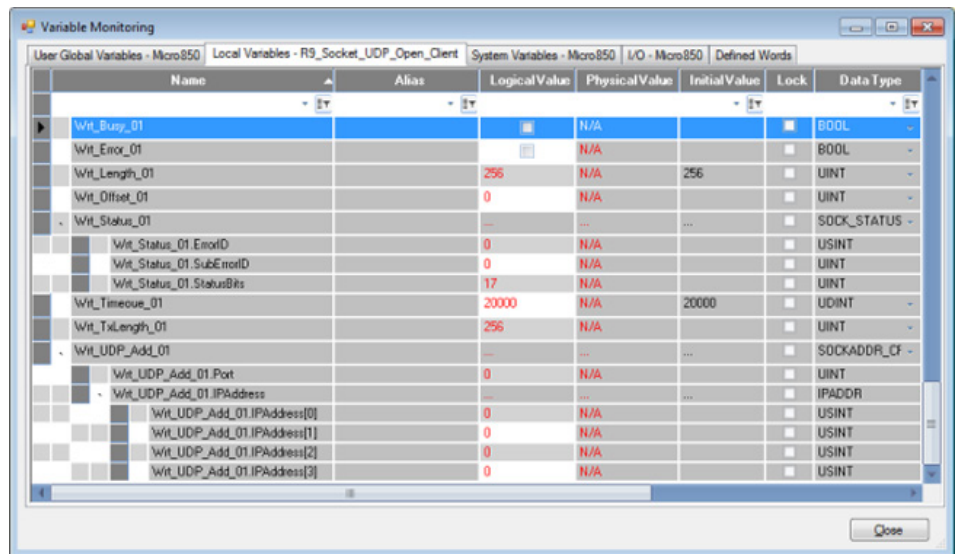

### SOCKADDR\_CFG data type

The following table describes the **SOCKADDR\_CFG** data type.

Parameter	Data type	Description
Port	UINT	Specify a local port number on which an application is listening and receiving.
IP Address[4]	USINT	Specify an IP address.  Example for an IP Address of 192.168.2.100: <ul style="list-style-type: none"> <li>• IPAddress [ 0 ]=192</li> <li>• IPAddress [ 1 ]=168</li> <li>• IPAddress [ 2 ]=2</li> <li>• IPAddress [ 3 ]=100</li> </ul>

### SOCK\_STATUS data type

The following table describes the **SOCK\_STATUS** data type.

Parameter	Data type	Description
ErrorID	USINT	<a href="#">Error Code</a> on <a href="#">page 599</a> Value.
SubErrorID	UINT	Sub Error Code Value.
StatusBits	UINT	Execution <a href="#">Status bits for Socket instructions</a> on <a href="#">page 602</a> .

## Socket error codes

The following table describes the status error codes for Socket instructions.

ErrorID code	SubErrorID code	Error description	Corrective action
0		The Socket instruction successfully completed operation.	
1		The Socket instruction is pending.	
2		The Socket Instance is not available.	Confirm the Socket Instance is not deleted or the Timeout value exceeded.
3		The <b>SOCKET_DELETEALL</b> operation is ongoing.	Wait for the pending <b>SOCKET_DELETEALL</b> operation to complete.
4	1	Illegal Parameter, Invalid Channel.	No action. Reserved for future use.
4	2	Illegal Parameter, Invalid Socket IP Address. <ul style="list-style-type: none"> <li>• Error occurs. <b>SOCKET_CREATE</b> contains a <b>SockAddr</b> with any non zero value.</li> <li>• <b>SOCKET_OPEN</b> or <b>SOCKET_WRITE</b> execute with an invalid target IP Address. Invalid target IP Addresses are: <ul style="list-style-type: none"> <li>• Self IP Address</li> <li>• 0.0.0.0</li> <li>• Loop back Address (127.x.x.x)</li> <li>• Class D Multicast Address (224.x.x.x)</li> <li>• Local Link Address (169.254.x.x)</li> <li>• Broadcast Address (Only applicable for TCP Socket Instance)</li> </ul> </li> </ul>	Change to a valid IP Address.
4	3	Illegal Parameter, Invalid Socket Port Address. Error occurs when the following Ports are specified in <b>SOCKET_CREATE</b> , <b>SOCKET_OPEN</b> , or <b>SOCKET_WRITE</b> : <ul style="list-style-type: none"> <li>• TCP Ports <ul style="list-style-type: none"> <li>• 44818 - EtherNet/IP</li> <li>• 502 -ModbusTCP</li> <li>• 67 - DHCP Server</li> <li>• 68 - DHCP Client</li> <li>• 0 - Invalid Port</li> </ul> </li> <li>• UDP Ports <ul style="list-style-type: none"> <li>• 2222 - EtherNet/IP</li> <li>• 67 - DHCP Server</li> <li>• 68 - DHCP Client</li> <li>• 0 - Invalid Port</li> </ul> </li> </ul>	Change the Port Address.
4	4	Illegal Parameter, Invalid Socket Type. Valid Socket Types are: <ul style="list-style-type: none"> <li>• TCP - 1</li> <li>• UDP - 2</li> </ul>	Change Socket Type.

ErrorID code	SubErrorID code	Error description	Corrective action
4	5	<p>Illegal Parameter, Invalid Socket Timeout value.</p> <p>Valid Timeout values are:</p> <ul style="list-style-type: none"> <li>• <b>SOCKET_CREATE</b>, <b>SOCKET_ACCEPT</b>, and <b>SOCKET_READ</b>: <ul style="list-style-type: none"> <li>• 0 (Default), or any value between 1000 and 86400000ms.</li> </ul> </li> <li>• <b>SOCKET_OPEN</b> and <b>SOCKET_WRITE</b>: <ul style="list-style-type: none"> <li>• 0 (Default), or any value between 1000 and 86400000ms.</li> </ul> </li> </ul>	Change the Timeout value to a valid value.
4	6	<p>Illegal Parameter, Invalid Socket Instance.</p> <ul style="list-style-type: none"> <li>• TCP Server Socket Type: <ul style="list-style-type: none"> <li>• Use the Socket Instance returned in <b>SOCKET_ACCEPT</b> for <b>SOCKET_WRITE</b>, <b>SOCKET_READ</b>, <b>SOCKET_DELETE</b>, and <b>SOCKET_INFO</b>.</li> </ul> </li> <li>• UDP Socket and TCP Client Socket Types: <ul style="list-style-type: none"> <li>• Use the Socket Instance returned in <b>SOCKET_CREATE</b> for <b>SOCKET_OPEN</b>, <b>SOCKET_WRITE</b>, <b>SOCKET_READ</b>, <b>SOCKET_DELETE</b>, and <b>SOCKET_INFO</b>.</li> </ul> </li> </ul>	Use the Instance Number returned in <b>SOCKET_CREATE</b> and <b>SOCKET_ACCEPT</b> instructions after successful execution.
4	7	Illegal Parameter, Invalid Array Length.	Increase the size of the array used to contain the Socket read and write data.
4	8	Illegal Parameter, Invalid Array Dimension.	Use single dimensional array to contain the Socket read and write data.
5		<p>Socket request to cancel operation.</p> <p>Error occurs when:</p> <ul style="list-style-type: none"> <li>• Ethernet Link is Disabled or Ethernet Cable is Disconnected</li> <li>• <b>SOCKET_DELETE</b> operation is performed when <b>SOCKET_OPEN</b>, <b>SOCKET_ACCEPT</b>, <b>SOCKET_READ</b>, or <b>SOCKET_WRITE</b> operation are in progress.</li> <li>• Run Mode Change operation is performed when <b>SOCKET_OPEN</b>, <b>SOCKET_ACCEPT</b>, <b>SOCKET_READ</b>, or <b>SOCKET_WRITE</b> operation are in progress.</li> <li>• IP Address Collision detected when <b>SOCKET_OPEN</b>, <b>SOCKET_ACCEPT</b>, <b>SOCKET_READ</b>, or <b>SOCKET_WRITE</b> operation are in progress.</li> </ul>	Restart the Socket operation based on Socket Type. Refer to the respective State Machine to restart Socket operation.
6	1	<p>Illegal Socket Sequence, Socket Open Operation in progress or Connected.</p> <p>Error occurs when:</p> <ul style="list-style-type: none"> <li>• <b>SOCKET_OPEN</b> is in progress (BUSY State) and user executes another <b>SOCKET_OPEN</b> instance with same socket instance.</li> <li>• <b>SOCKET_OPEN</b> is in progress (BUSY State) and user executes <b>SOCKET_ACCEPT</b> with same socket instance.</li> </ul>	Use single <b>SOCKET_OPEN</b> execution for respective Socket Instance. Do not perform <b>SOCKET_ACCEPT</b> operation for same socket instance.
6	2	<p>Illegal Socket Sequence, Socket Accept Operation In progress or Connected.</p> <p>Error occurs when:</p> <ul style="list-style-type: none"> <li>• <b>SOCKET_ACCEPT</b> is in progress (BUSY State) and user executes another <b>SOCKET_ACCEPT</b> instance with same socket instance.</li> <li>• <b>SOCKET_ACCEPT</b> is in progress (BUSY State) and user executes <b>SOCKET_OPEN</b> with same socket instance.</li> </ul>	Use single <b>SOCKET_ACCEPT</b> execution for respective Socket Instance. Do not perform <b>SOCKET_OPEN</b> operation for same socket instance.
6	3	Illegal Socket Sequence, Socket configured as TCP Client.	
6	4	Illegal Socket Sequence, Socket configured as TCP Server.	
6	5	Illegal Socket Sequence, Socket is Connected.	Make sure the Socket is not already connected with a remote device before executing <b>SOCKET_OPEN</b> or <b>SOCKET_ACCEPT</b> again.



ErrorID code	SubErrorID code	Error description	Corrective action
6	6	Illegal Socket Sequence, Socket configured as UDP.	Make sure UDP Socket Instances are not used with <b>SOCKET_ACCEPT</b> .
6	7	Illegal Socket Sequence, Socket is not connected.	Confirm that Socket is connected with the target.
7		Socket Instance Timeout.	Configure Timeout values for <b>SOCKET_ACCEPT</b> , <b>SOCKET_OPEN</b> , <b>SOCKET_READ</b> , and <b>SOCKET_WRITE</b> accordingly.
8		The Socket module is not initialized.	Make sure the Ethernet Link is Enabled or Ethernet Cable of Controller is connected to the Network or resolve Controller IP Address conflict.
9	1	Socket Instruction Fatal Error, Socket Instance Missing.	
9	2	Socket Instruction Fatal Error, Invalid Socket Instance.	
9	3	Socket Instruction Fatal Error, Invalid Lock Socket Instance.	
9	4	Socket Instruction Fatal Error, Invalid Socket Type.	
9	5	Socket Instruction Fatal Error, Missing Cancel Handler.	
10	1	Socket background processing Error, Address in Use.	
10	2	Socket background processing Error, UDP Received a Large Packet and the Packet is larger than Socket Read length.	Make sure the <b>SOCKET_READ</b> Length is equal to greater than the received packet size. Max read size is recommended. Max size for <b>SOCKET_READ</b> is 256.
10	3	Socket background processing Error, TCP Receive Large packet. Packet received is larger than the Socket Read length.	Make sure the <b>SOCKET_READ</b> Length is equal to greater than the received packet size. Since client may send up to the receive window size of 256, 256 is recommended.
10	4	Socket background processing Error, Received RST or Disconnect from Remote Device.	Restart Controller TCP Client or Server as shown in the State Diagram. Verify the Target device that sent RST and make sure the Target is restarted with correct state.
10	5	Socket background processing Error, UDP Packet received from different device, drop packet. Reserved for future.	
10	6	Socket background processing Error, Queue is full. Error occurs when: <ul style="list-style-type: none"> <li>• <b>SOCKET_READ</b> or <b>SOCKET_WRITE</b> execute four instructions for the same Socket instance in same scan.</li> <li>• Perform a <b>SOCKET_READ</b> when four <b>SOCKET_READ</b> instructions are in <b>BUSY</b> state for same Socket instance.</li> </ul>	Wait for <b>SOCKET_READ</b> and <b>SOCKET_WRITE</b> queue availability for respective Socket instance.
10	7	Socket background processing Error, <b>SOCKET_READ</b> Parameter change (Length, Offset, Data Array Size, and Data Array Variable).	When the <b>SOCKET_READ</b> state is <b>BUSY</b> , do not modify the input parameters.
11	1	Socket background processing Fatal Error, Missing data pointer.	
11	2	Socket background processing Fatal Error, Missing Session Pointer.	
11	3	Socket background processing Fatal Error, Invalid TCP or UDP Socket pointer.	
11	4	Socket background processing Fatal Error, Invalid Socket Instance Type.	
11	5	Socket background processing Fatal Error, Socket Instance Missing.	
11	6	Socket background processing Fatal Error, Invalid Socket Instance.	
11	7	Socket background processing Fatal Error, Invalid Socket State.	
11	8	Socket background processing Fatal Error, Invalid Socket Type.	
11	9	Socket background processing Fatal Error, TCP delete Failure.	
11	10	Socket background processing Fatal Error, UDP delete Failure.	
128	1	No packet available for disconnect message.	
128	2	Not enough room to pre-pend the TCP header.	

ErrorID code	SubErrorID code	Error description	Corrective action
128	3	Packet append pointer is invalid.	
128	7	Invalid Socket pointer.	
128	10	Invalid type-of-service, fragment, or time-to-live option.	
128	17	Invalid caller for this service.	
128	18	Packet is not valid.	
128	20	This component has not been enabled.	
128	21	This component has already been enabled.	
128	22	Listening is not enabled for the specified port.	
128	26	Requested suspension was aborted.	
128	33	Invalid server IP Address.	
128	34	This socket is bound to another port.	
128	35	Port is bound to a different socket.	
128	36	Socket is not bound.	
128	38	The Socket was unbound while suspended waiting for a receive packet.	
128	39	Socket was not created.	
128	51	No additional listen request structures are available.	
128	52	There is already an active listen request for this port.	
128	53	Socket is not in a closed state.	
128	54	The server socket supplied is not in a listen state.	
128	55	No wait time was specified, the connection attempt is in progress.	
128	56	Connection failed.	
128	57	Request is greater than the receiver's advertised window size in bytes.	
128	64	Another thread is suspended. Only one thread is allowed.	
128	65	Disconnect failed to complete within the Timeout period.	
128	66	Socket is bound.	
128	69	No available Port.	
128	70	Invalid Port.	
128	71	There is already a valid Socket pointer for this port or the specified port does not have an active listen request.	
128	72	Same as <b>NX_SUCCESS</b> , except a queued connection request was processed during this call.	
128	73	TCP Transmit Queue Exceeded Error.	

## Socket instruction status bits

The following table describes the execution status bits for [socket instructions](#) on [page 567](#).

Bit Number	Name	Description
0	EN - Enable Bit	The EN bit is set when the instruction is enabled due to a False-to-True transition, but has not yet completed or erred.
1	EW - Enable Wait Queue Bit	The EW bit is set when the controller detects that a Socket instruction request has entered into queue. The controller resets the EW bit when the ST bit is set.
2	ST - Start Bit	The ST bit is set when the queued instruction is executing. The ST bit is reset when the DN or ER bit is set.

Bit Number	Name	Description
3	ER - Error Bit	Indicates that an error occurred while executing the instruction. The ER bit is reset the next time the run-condition-in goes from False to True.
4	DN - Done Bit	The DN bit is set when the Socket instruction completes successfully. The DN bit is reset the next time the run-condition-in goes from False to True.

## Socket instruction timing diagrams

### Successful execution for [Socket instructions on page 567](#) when process is immediate

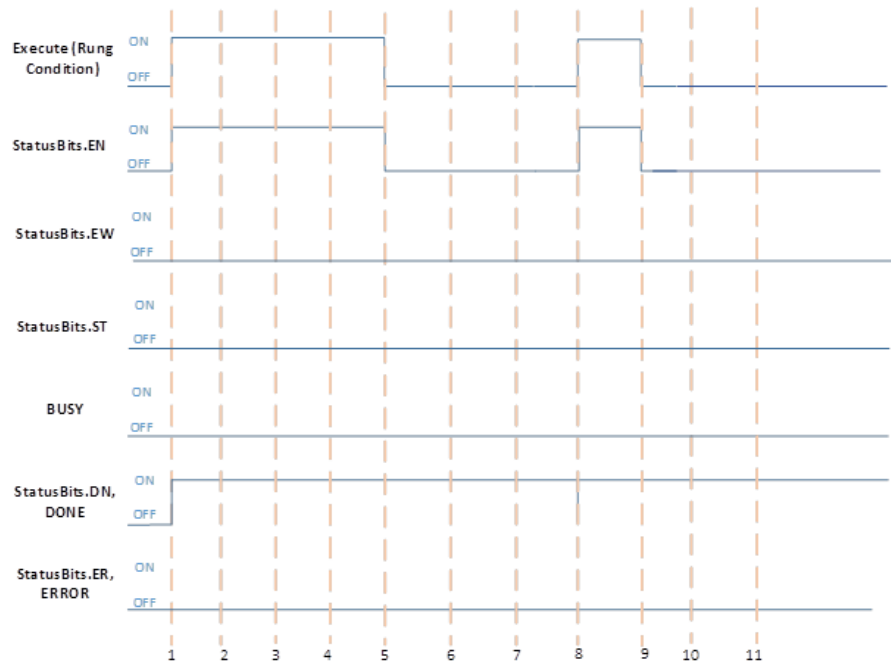

### Condition A: Rung condition is TRUE during instructions execution

Rung Condition	Description
1	Rung condition becomes TRUE when: <ul style="list-style-type: none"> <li>• Socket instructions execution is enabled.</li> <li>• EN bit is set and all other bits are cleared.</li> <li>• Socket instructions completes execution successfully.</li> <li>• Output for DN bit and DONE is set.</li> </ul>
2,3,4	No change in Rung condition.
5	Rung condition becomes FALSE when EN bit is cleared.
6,7	No change in Rung condition.

### Condition B: Rung condition is FALSE during instructions execution

Rung Condition	Description
8	Rung condition becomes TRUE when: <ul style="list-style-type: none"> <li>• Socket instructions execution is enabled.</li> <li>• Socket instructions completes execution successfully.</li> <li>• EN bit is set and all other bits are cleared.</li> <li>• Output for DN bit and DONE is set.</li> </ul>
9	Rung condition becomes FALSE when: <ul style="list-style-type: none"> <li>• EN bit is cleared.</li> </ul>
10,11	No change in Rung condition.

### Successful execution for Socket instructions when process is non-immediate

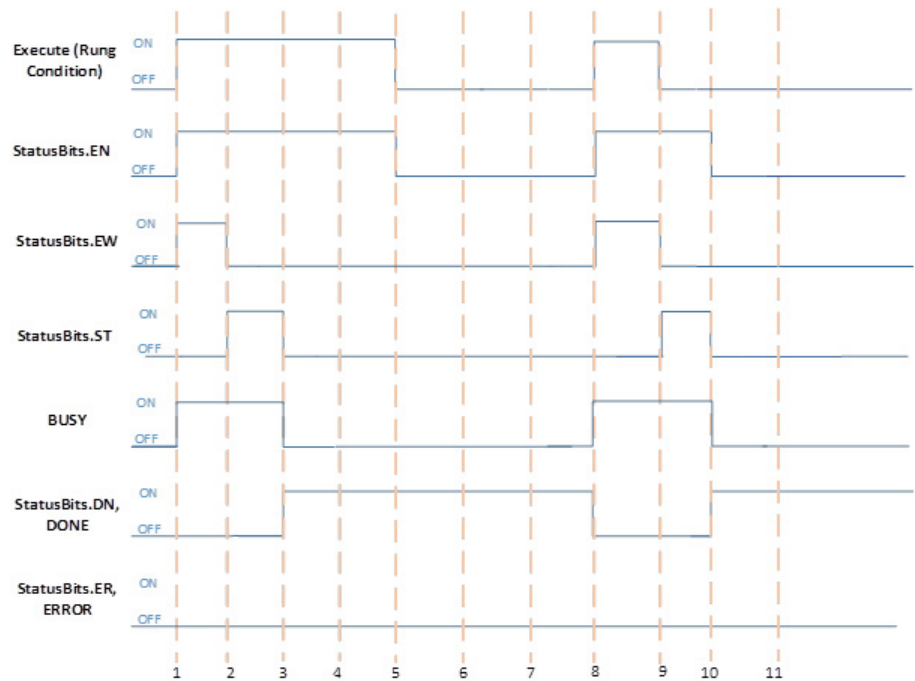

### Condition A: Rung condition is TRUE during instructions execution

Rung Condition	Description
1	Rung condition becomes TRUE when: <ul style="list-style-type: none"> <li>• Socket instructions execution is enabled.</li> <li>• EN bit is set and all other bits are cleared.</li> <li>• Socket instructions perform background processing.</li> <li>• Output for EW bit and BUSY is set.</li> <li>• Locked Socket instructions input parameter for background processing.</li> </ul>

Rung Condition	Description
2	Socket instructions start execution when: <ul style="list-style-type: none"> <li>• EW bit is cleared.</li> <li>• ST bit is set.</li> </ul>
3	Socket instructions complete execution successfully when: <ul style="list-style-type: none"> <li>• Output for ST bit and BUSY is cleared.</li> <li>• Output for DN bit and DONE is set.</li> </ul>
4	No change in Rung condition.
5	Rung condition becomes FALSE when: <ul style="list-style-type: none"> <li>• EN bit is cleared.</li> </ul>
6,7	No change in Rung condition.

### Condition B: Rung condition goes FALSE during instructions execution

Rung Condition	Description
8	Rung condition becomes TRUE when: <ul style="list-style-type: none"> <li>• Socket instructions execution is enabled.</li> <li>• EN bit is set and all other bits are cleared.</li> <li>• Socket instructions send for background processing.</li> <li>• Output for EW bit and BUSY is set.</li> <li>• Locked Socket instructions input parameter for background processing.</li> </ul>
9	Socket instructions start execution when: <ul style="list-style-type: none"> <li>• EW bit is cleared.</li> <li>• ST bit is set.</li> <li>• Rung condition becomes FALSE.</li> </ul>
10	Socket instructions complete execution successfully when: <ul style="list-style-type: none"> <li>• Output for ST bit and BUSY are cleared.</li> <li>• Output for DN bit and DONE is set.</li> <li>• Rung condition is FALSE.</li> <li>• EN bit is cleared.</li> </ul>

### Socket instructions fail when EN is TRUE and EW and ST are FALSE

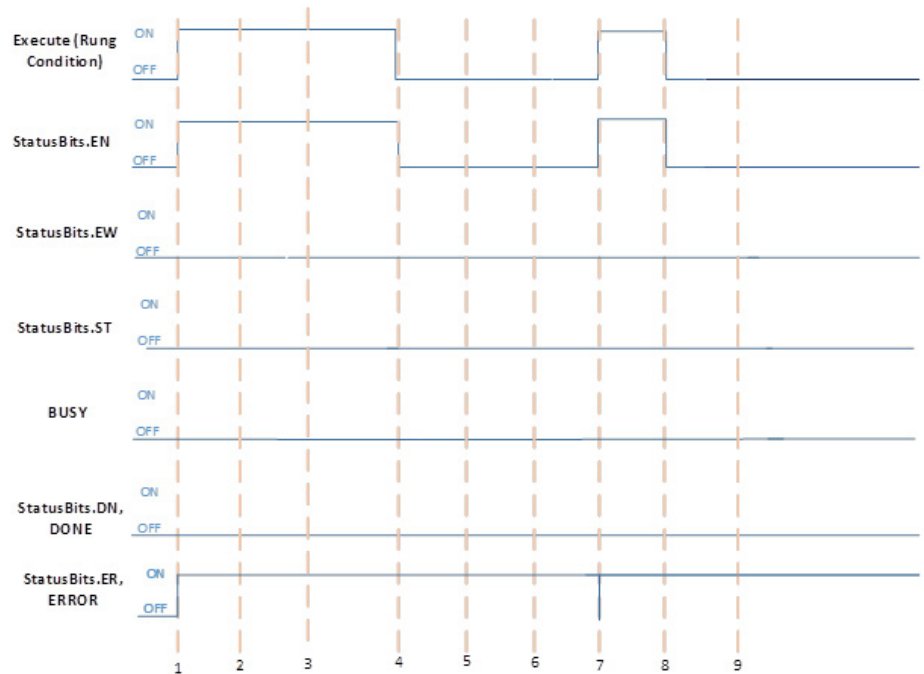

### Condition A: Rung condition is TRUE during instructions execution

Rung Condition	Description
1	Rung condition becomes TRUE when: <ul style="list-style-type: none"> <li>• Socket instructions execution is enabled.</li> <li>• EN bit is set and all other bits are cleared.</li> <li>• Socket instructions complete execution with error.</li> <li>• Output for ER bit and error is set.</li> </ul>
2,3	No change in Rung condition.
4	Rung condition becomes FALSE when: <ul style="list-style-type: none"> <li>• EN bit is cleared.</li> </ul>
5,6	No change in Rung condition.

### Condition B: Rung condition becomes FALSE during instructions execution

Rung Condition	Description
7	Rung condition becomes TRUE when: <ul style="list-style-type: none"> <li>• Socket instructions execution is enabled.</li> <li>• EN bit is set and all other bits are cleared.</li> <li>• Socket instructions complete execution with error.</li> <li>• Output for ER bit and error is set.</li> </ul>

Rung Condition	Description
8	Rung condition becomes FALSE when: <ul style="list-style-type: none"> <li>• EN bit is cleared.</li> </ul>
9	No change in Rung condition.

### Socket instructions fail when EW is TRUE and instruction process is non-immediate

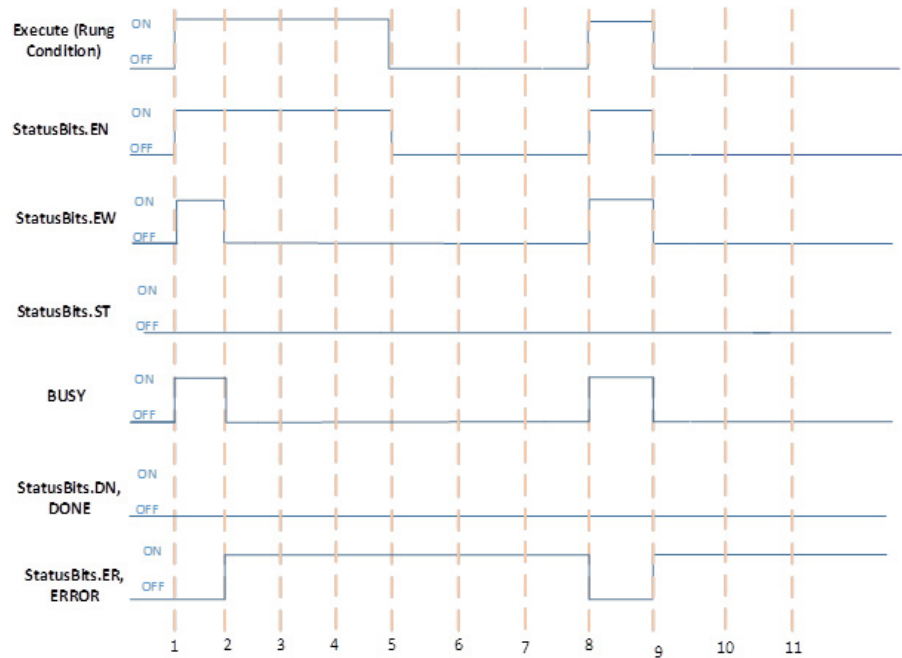

### Condition A: Rung condition is TRUE during instructions execution

Rung Condition	Description
1	Rung condition becomes TRUE when: <ul style="list-style-type: none"> <li>• Socket instructions execution is enabled.</li> <li>• EN bit is set and all other bits are cleared.</li> <li>• Socket instructions send for background processing.</li> <li>• Output for EW bit and BUSY is set.</li> <li>• Locked Socket instructions input parameter for background processing.</li> </ul>
2	Socket instructions complete execution with error when: <ul style="list-style-type: none"> <li>• Output for EW bit and BUSY is cleared.</li> <li>• Output for ER bit and error is set.</li> </ul>
3,4	No change in Rung condition.
5	Rung condition becomes FALSE when: <ul style="list-style-type: none"> <li>• EN bit is cleared.</li> </ul>
6,7	No change in Rung condition.

### Condition B: Rung condition becomes FALSE during instructions execution

Rung Condition	Description
8	Rung condition becomes TRUE when: <ul style="list-style-type: none"> <li>• Socket instructions execution is enabled.</li> <li>• EN bit is set and all other bits are cleared.</li> <li>• Socket instructions send for background processing.</li> <li>• Output for EW bit and BUSY is set.</li> <li>• Locked Socket instructions input parameter for background processing.</li> </ul>
9	Socket instructions complete execution with error when: <ul style="list-style-type: none"> <li>• Output for EW bit and BUSY is cleared.</li> <li>• Output for ER bit and error is set.</li> <li>• Rung condition becomes FALSE.</li> <li>• EN bit is cleared.</li> </ul>
10,11	No change in Rung condition.

### Socket instructions fail when ST is TRUE and instruction process is non-immediately

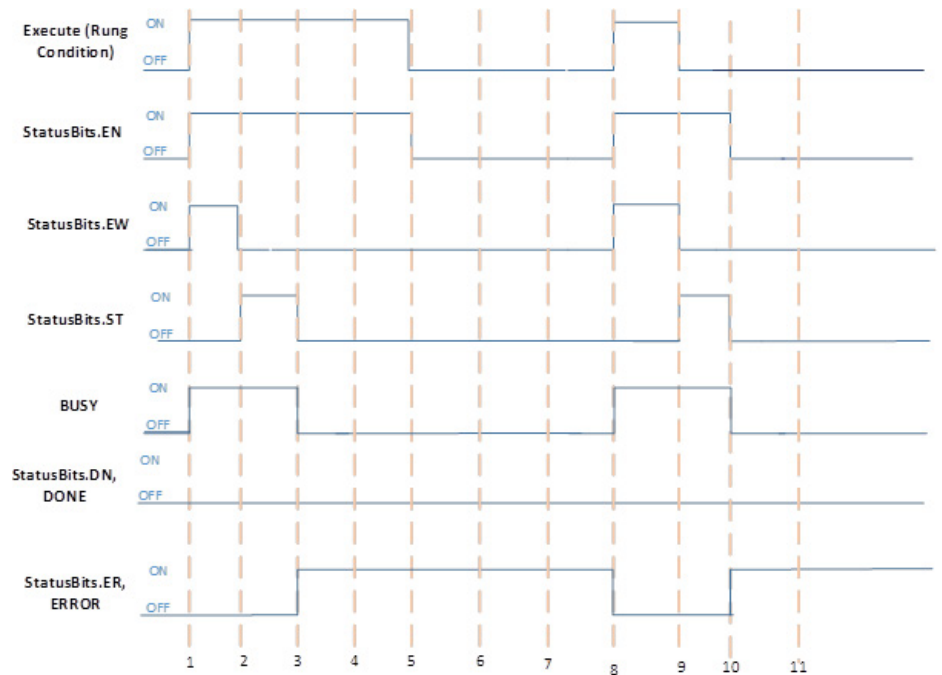

### Condition A: Rung condition is TRUE during instructions execution

Rung Condition	Description
----------------	-------------



Rung Condition	Description
1	Rung condition becomes TRUE when: <ul style="list-style-type: none"> <li>• Socket instructions execution is enabled.</li> <li>• EN bit is set and all other bits are cleared.</li> <li>• Socket instructions send for background processing.</li> <li>• Output for EW bit and BUSY output is set.</li> <li>• Locked Socket instructions input parameter for background processing.</li> </ul>
2	Socket instructions start execution when: <ul style="list-style-type: none"> <li>• EW bit is cleared</li> <li>• ST bit is set.</li> </ul>
3	Socket instructions complete execution with error when: <ul style="list-style-type: none"> <li>• Output for ST bit and BUSY output is cleared.</li> <li>• Output for ER bit and error is set.</li> </ul>
4	No change in Rung condition.
5	Rung condition becomes FALSE when: <ul style="list-style-type: none"> <li>• EN bit is cleared.</li> </ul>
6,7	No change in Rung condition.

### Condition B: Rung condition becomes FALSE during instructions execution

Rung Condition	Description
8	Rung condition becomes TRUE when: <ul style="list-style-type: none"> <li>• Socket instructions execution is enabled.</li> <li>• EN bit is set and all other bits are cleared.</li> <li>• Socket instructions send for background processing.</li> <li>• Output for EW bit and BUSY is set.</li> <li>• Locked Socket instructions input parameter for background processing.</li> </ul>
9	Socket instructions start execution when: <ul style="list-style-type: none"> <li>• EW bit is cleared and ST bit is set.</li> </ul>
10	Socket instructions complete execution with error when: <ul style="list-style-type: none"> <li>• Output for ST bit and BUSY is cleared.</li> <li>• Output for ER bit and error is set.</li> <li>• Rung condition becomes FALSE.</li> <li>• EN bit is cleared.</li> </ul>
11	No change in Rung condition.

## Socket instruction transaction diagrams

### Transactions for TCP Client

The following diagram shows a typical sequence of socket interface transactions with the controller acting as a TCP client.

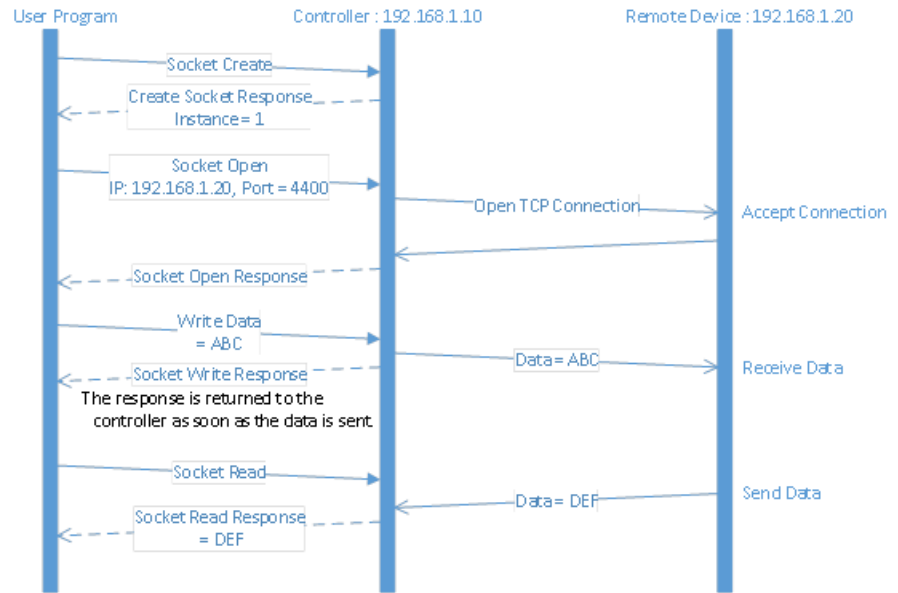

## Transactions for TCP Server

The following diagram shows a typical sequence of socket interface transactions with the controller as a TCP server.

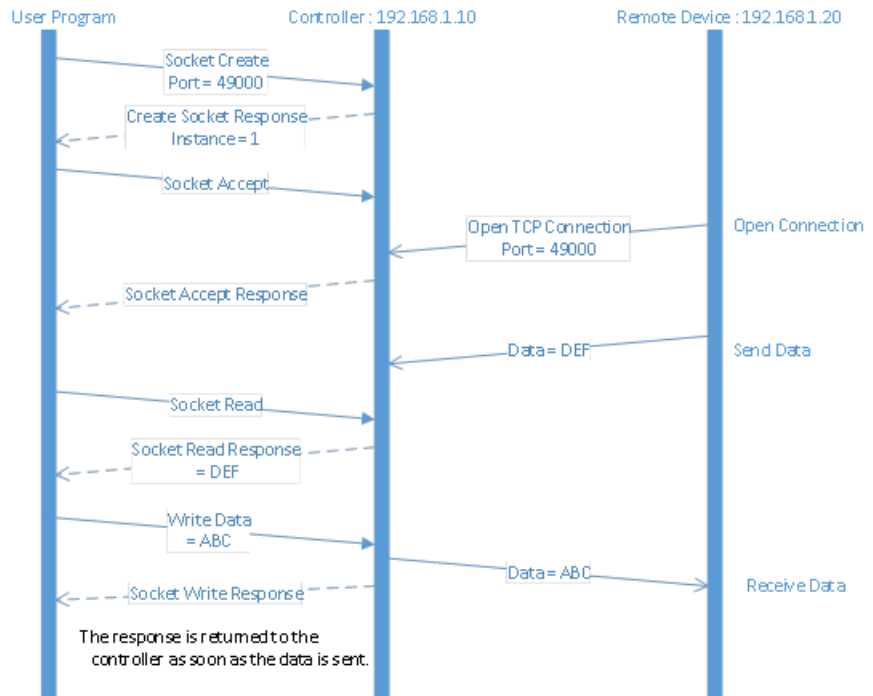

## Transactions for UDP with Open Connection

The following diagram shows a typical sequence of socket interface transactions for UDP communications when using the Open Connection service to specify the destination address.

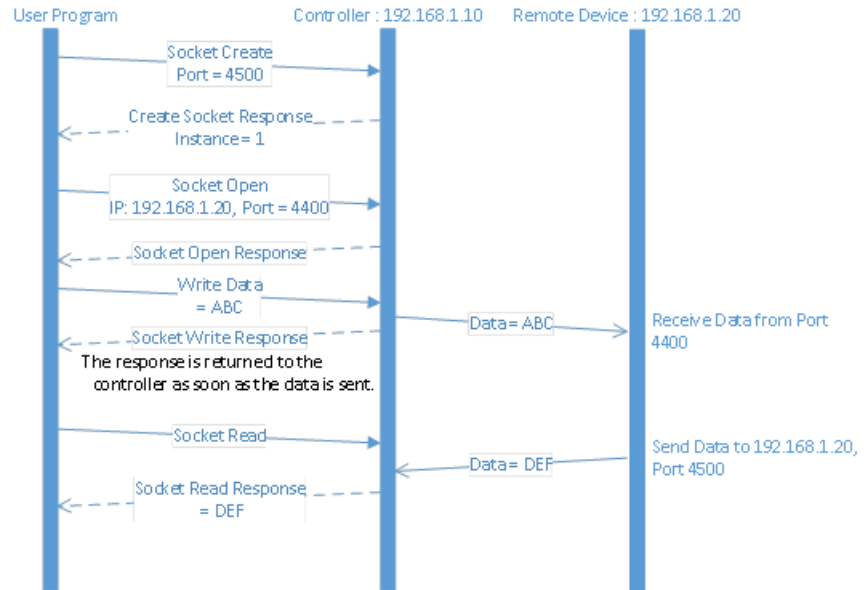

### Transactions for UDP without Open Connections

The following diagram shows a typical sequence of socket interface transactions for UDP communications without using the Open Connection service to specify the destination address. In this case, the controller specifies the destination for each datagram and receives the sender's address along with each datagram it receives.

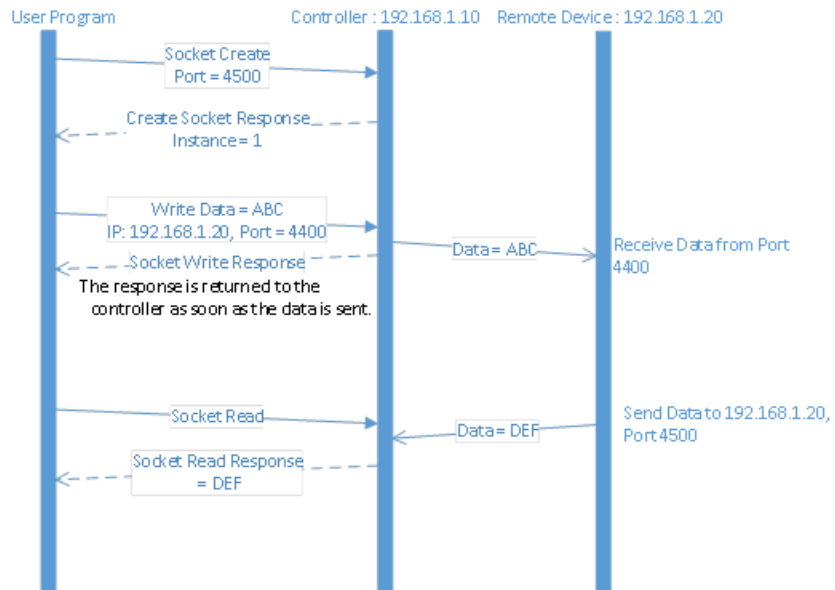

### State machine diagrams for TCP

TCP Client using [Socket instructions on page 567](#)

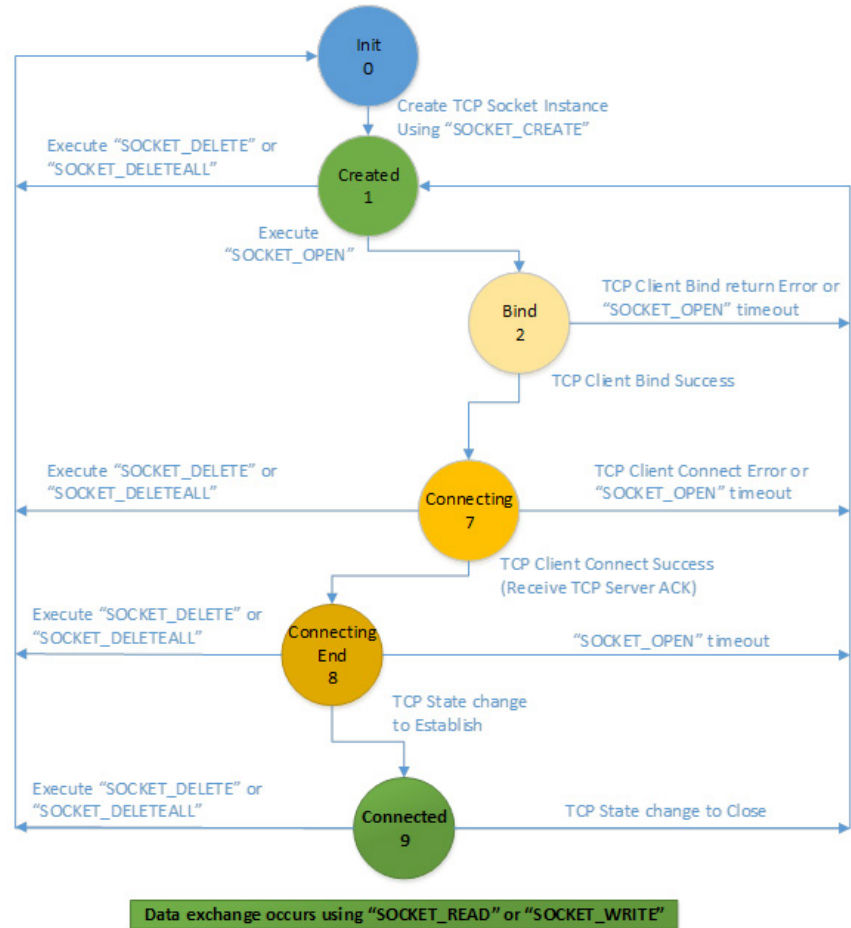

### TCP Server using Socket instructions

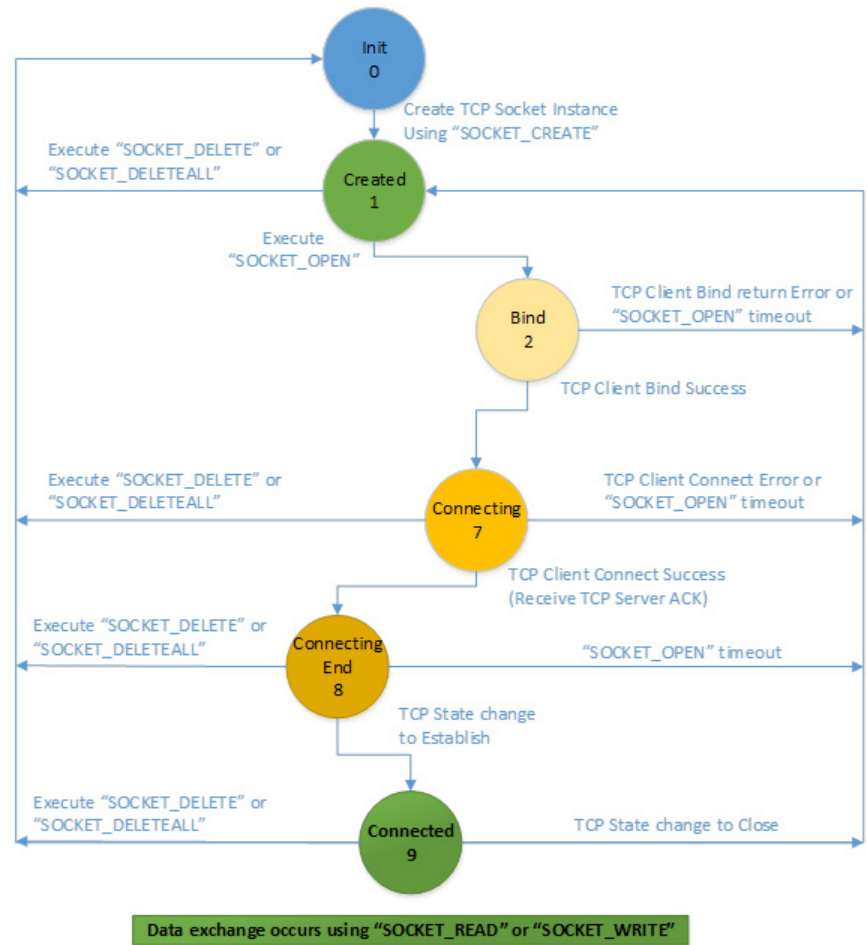

### TCP State Diagram

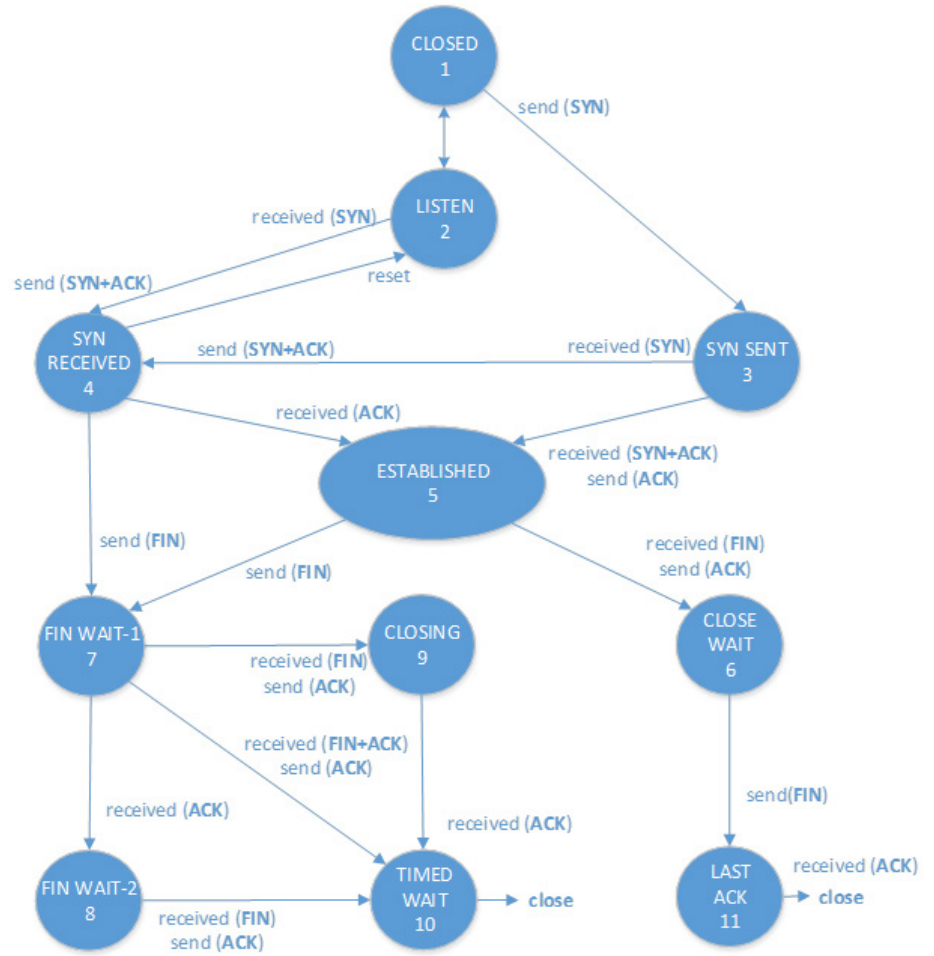

State machine diagrams for UDP

UDP Datagram with SOCKET\_OPEN instruction

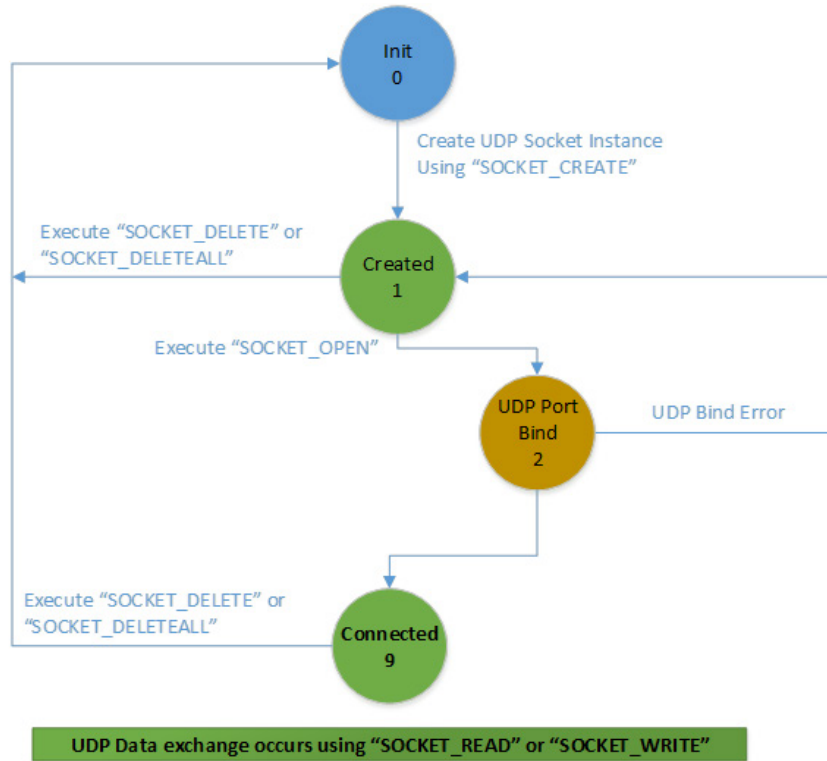

### UDP Datagram without SOCKET\_OPEN instruction

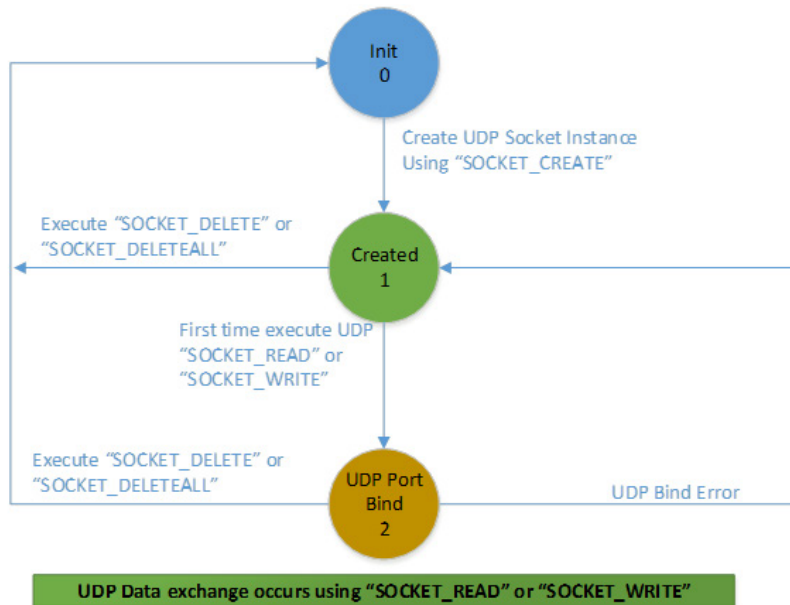





## String manipulation instructions

Use String manipulation instructions to alter a sequence of symbols that are chosen from a set or alphabet to change the output status. To read input strings containing special characters correctly, input the string characters after the program containing the function block instance is online.

Instruction	Description
<a href="#">ASCII</a> on <a href="#">page 617</a>	Returns the ASCII code for characters in a string. Character -> ASCII code.
<a href="#">CHAR</a> on <a href="#">page 619</a>	Returns a one character string for an ASCII code. ASCII code -> character.
<a href="#">DELETE</a> on <a href="#">page 620</a>	Deletes characters from a string.
<a href="#">FIND</a> on <a href="#">page 622</a>	Locates and provides the position of sub-strings within strings.
<a href="#">INSERT</a> on <a href="#">page 624</a>	Inserts sub-strings at user-defined positions within strings.
<a href="#">LEFT</a> on <a href="#">page 626</a>	Extracts characters from the left side of a string.
<a href="#">MID</a> on <a href="#">page 628</a>	Extracts characters from the middle of a string.
<a href="#">MLEN</a> on <a href="#">page 630</a>	Calculates the length of a string.
<a href="#">REPLACE</a> on <a href="#">page 633</a>	Replaces parts of a string with new sets of characters.
<a href="#">RIGHT</a> on <a href="#">page 631</a>	Extracts characters from the right side of a string.

### ASCII

Returns the ASCII code for characters in strings.

Languages supported: Function Block Diagram, Ladder Diagram, Structured Text.

This instruction applies to the Micro810, Micro820, Micro830, Micro850, Micro870 controllers and Micro800 Simulator.

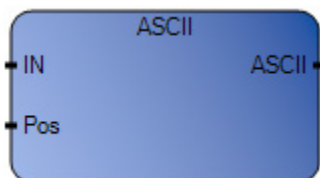

Use this table to help determine the parameter values for this instruction.

Parameter	Parameter Type	Data Type	Description
EN	Input	BOOL	Instruction enable. TRUE - display the ASCII code for characters. FALSE - no display operation. Applies to Ladder Diagram programs.
IN	Input	STRING	Any non-empty string.
Pos	Input	DINT	Position of the selected character in set [1.. len](len is the length of the IN string).

Parameter	Parameter Type	Data Type	Description
ASCII	Output	DINT	ASCII code of the selected character (in set [0 .. 255]) yields 0 is Pos is out of the string.
ENO	Output	BOOL	Enable output. Applies to Ladder Diagram programs.

### ASCII Function Block Diagram example

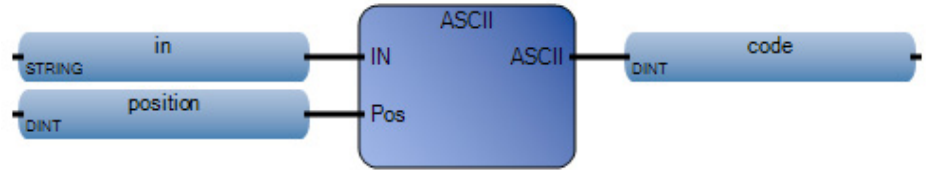

### ASCII Ladder Diagram example

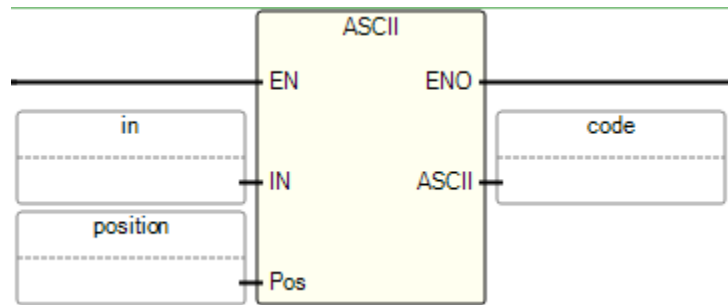

### ASCII Structured Text example

```

1 | position := 1;
2 | code := ASCII(in, position);

ASCII (
  DINT ASCII (STRING IN, DINT Pos)
  Character -> ASCII code

```

(\* ST Equivalence: \*)

FirstChr := ASCII (message, 1);

(\* FirstChr is the ASCII code of the first character of the string \*)

## Results

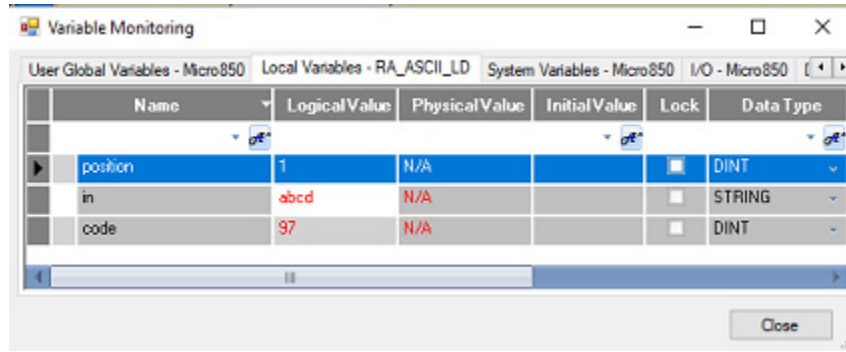

### CHAR (ASCII code to string character)

Returns a one character string for an ASCII code. ASCII code -> character.

Languages supported: Function Block Diagram, Ladder Diagram, Structured Text.

This instruction applies to the Micro810, Micro820, Micro830, Micro850, Micro870 controllers and Micro800 Simulator.



Use this table to help determine the parameter values for this instruction.

Parameter	Parameter Type	Data Type	Description
EN	Input	BOOL	Instruction enable. TRUE - provide a single character string. FALSE - no operation. Applies to Ladder Diagram programs.
Code	Input	DINT	ASCII code in set [0 .. 255].
CHAR	Output	STRING	One character string. The character has the ASCII code given in input code.
ENO	Output	BOOL	Enable output. Applies to Ladder Diagram programs.

### CHAR Function Block Diagram example

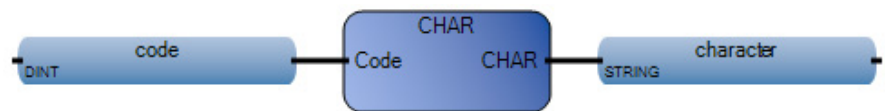

### CHAR Ladder Diagram example

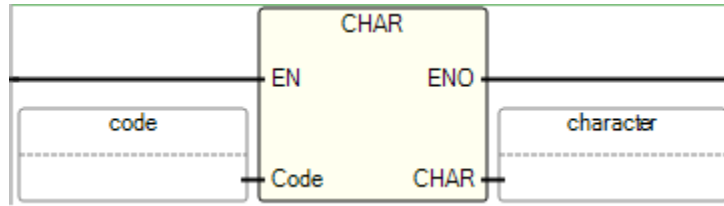

### CHAR Structured Text example

```

1 | code := 97;
2 | character := CHAR(code);

```

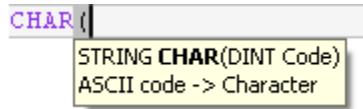

(\* ST Equivalence: \*)

Display := CHAR ( value + 48 );

(\* value is in set [0..9] \*)

(\* 48 is the ascii code of '0' \*)

(\* result is one character string from '0' to '9' \*)

### Results

Name	Logical Value	Physical Value	Initial Value	Lock	Data Type
code	97	N/A		<input type="checkbox"/>	DINT
character	a	N/A		<input type="checkbox"/>	STRING

### DELETE (delete sub-string)

Deletes characters from a string.

Languages supported: Function Block Diagram, Ladder Diagram, Structured Text.

This instruction applies to the Micro810, Micro820, Micro830, Micro850, Micro870 controllers and Micro800 Simulator.

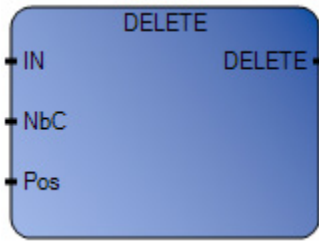

Use this table to help determine the parameter values for this instruction.

Parameter	Parameter Type	Data Type	Description
EN	Input	BOOL	Instruction enable. TRUE - delete specified part of a string. FALSE - no operation. Applies to Ladder Diagram programs.
IN	Input	STRING	Any non-empty string.
NbC	Input	DINT	Number of characters to be deleted.
Pos	Input	DINT	Position of the first deleted character (first character of the string has position 1).
DELETE	Output	STRING	Output is: <ul style="list-style-type: none"> <li>• a modified string.</li> <li>• an empty string (if Pos &lt; 1).</li> <li>• the initial string (if Pos &gt; IN string length).</li> <li>• the initial string (if NbC &lt;= 0).</li> </ul>
ENO	Output	BOOL	Enable output. Applies to Ladder Diagram programs.

### DELETE Function Block Diagram example

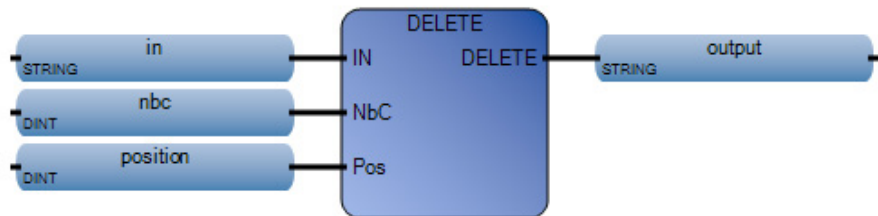

### DELETE Ladder Diagram example

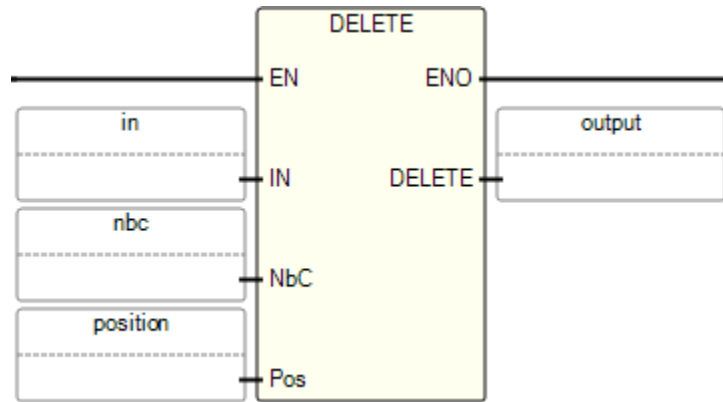

### DELETE Structured Text example

```
DELETE (
STRING DELETE (STRING IN, DINT NbC, DINT Pos)
Delete sub-string
```

```
1 nbc := 3;
2 position := 2;
3 output := DELETE (in, nbc, position);
```

(\* ST Equivalence: \*)

complete\_string := INSERT ('ABCD', 'EFGH', 5); (\* complete\_string is 'ABCDEFGH' \*)

sub\_string := DELETE (complete\_string, 4, 3); (\* sub\_string is 'ABGH' \*)

### Results

Name	Logical Value	Physical Value	Initial Value	Lock	Data Type
in	abcde g	N/A		<input type="checkbox"/>	STRING
nbc	3	N/A		<input type="checkbox"/>	DINT
output	ae fg	N/A		<input checked="" type="checkbox"/>	STRING
position	2	N/A		<input type="checkbox"/>	DINT

### FIND (find sub-string)

Locates and provides the position of sub-strings within strings.

This instruction applies to the Micro810, Micro820, Micro830, Micro850, Micro870 controllers and Micro800 Simulator.

This instruction applies to the Micro810, Micro820, Micro830, Micro850, Micro870 controllers and Micro800 Simulator.



Use this table to help determine the parameter values for this instruction.

Parameter	Parameter Type	Data Type	Description
EN	Input	BOOL	Instruction enable. TRUE - locate position within strings. FALSE - no locate operation. Applies to Ladder Diagram programs.
In	Input	STRING	Any non-empty string.
Pat	Input	STRING	Any non-empty string (Pattern).
FIND	Output	DINT	Output is: <ul style="list-style-type: none"> <li>• 0 if the sub string Pat is not found.</li> <li>• the position of the first character of the first occurrence of the sub-string Pat (first position is 1)</li> </ul> This instruction is case sensitive.
ENO	Output	BOOL	Enable output. Applies to Ladder Diagram programs.

### FIND Function Block Diagram example

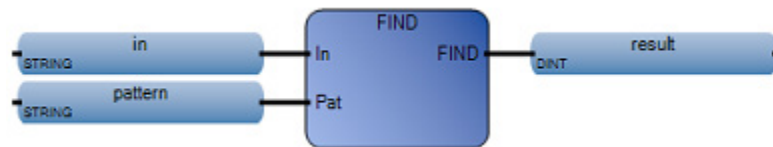

### FIND Ladder Diagram example

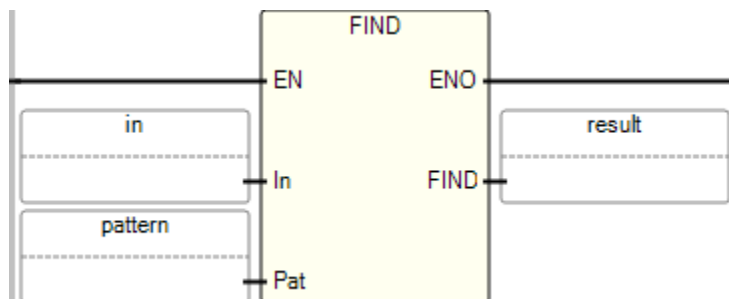

## FIND Structured Text example

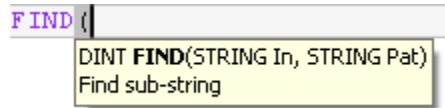

```
1 result := FIND(in, pattern);
```

(\* ST Equivalence: \*)

complete\_string := 'ABCD' + 'EFGH'; (\* complete\_string is 'ABCDEFGH' \*)

found := FIND (complete\_string, 'CDEF'); (\* found is 3 \*)

## Results

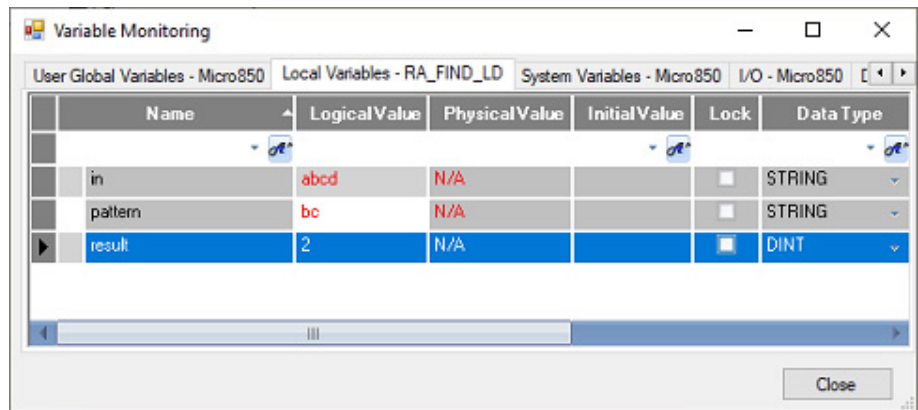

## INSERT (insert string)

Inserts sub-strings at user-defined positions within strings.

Languages supported: Function Block Diagram, Ladder Diagram, Structured Text.

This instruction applies to the Micro810, Micro820, Micro830, Micro850, Micro870 controllers and Micro800 Simulator.



Use this table to help determine the parameter values for this instruction.

Parameter	Parameter Type	Data Type	Description
EN	Input	BOOL	Instruction enable. TRUE - insert sub-strings in a string. FALSE - no operation. Applies to Ladder Diagram programs.



Parameter	Parameter Type	Data Type	Description
IN	Input	STRING	Initial string.
Str	Input	STRING	String to be inserted.
Pos	Input	DINT	Position of the insertion the insertion is done before the position (first valid position is 1).
INSERT	Output	STRING	Modified string. Can be: <ul style="list-style-type: none"> <li>• empty string if Pos &lt;= 0</li> <li>• concatenation of both strings if Pos is greater than the length of the IN string</li> </ul>
ENO	Output	BOOL	Enable output. Applies to Ladder Diagram programs.

### INSERT Function Block Diagram example

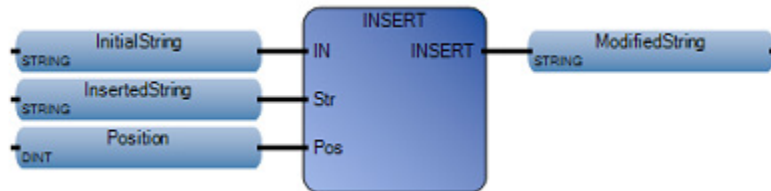

### INSERT Ladder Diagram example

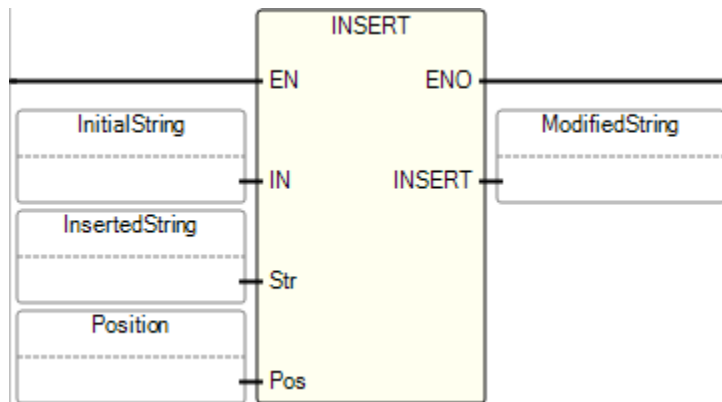

### INSERT Structured Text example

```
INSERT {
    STRING INSERT(STRING IN, STRING Str, DINT Pos)
    Insert string
```

```
1 Position := 3;
2 ModifiedString := INSERT(InitialString, InsertedString, Position);
```

```
(* ST Equivalence: *)
MyName := INSERT ('Mr JONES', 'Frank ', 4);
(* MyName is 'Mr Frank JONES' *)
```

### Results

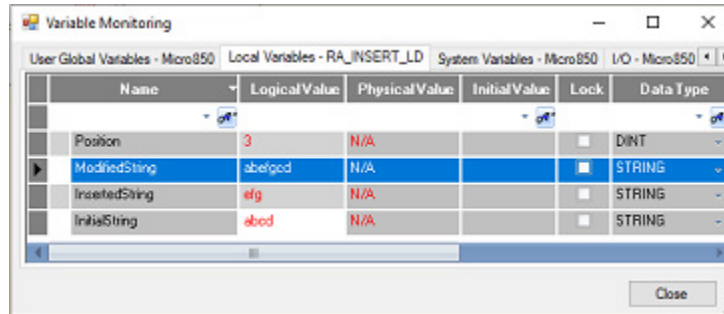

### LEFT (extract left of a sting)

Extract characters from the left side of a string.

Languages supported: Function Block Diagram, Ladder Diagram, Structured Text.

This instruction applies to the Micro810, Micro820, Micro830, Micro850, Micro870 controllers and Micro800 Simulator.

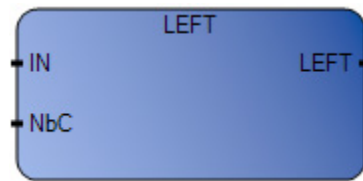

Use this table to help determine the parameter values for this instruction.

Parameter	Parameter Type	Data Type	Description
EN	Input	BOOL	Instruction enable. TRUE - calculate number of characters from left side of string. FALSE - no operation. Applies to Ladder Diagram programs.
IN	Input	STRING	Any non-empty string.
NbC	Input	DINT	Number of characters to be extracted. This number cannot be greater than the length of the IN string.
LEFT	Output	STRING	Left part of the IN string (its length = NbC). Can be: <ul style="list-style-type: none"> <li>empty string if NbC &lt;= 0</li> <li>complete IN string if NbC &gt;= IN string length</li> </ul>
ENO	Output	BOOL	Enable output. Applies to Ladder Diagram programs.

### LEFT Function Block Diagram example



### LEFT Ladder Diagram example

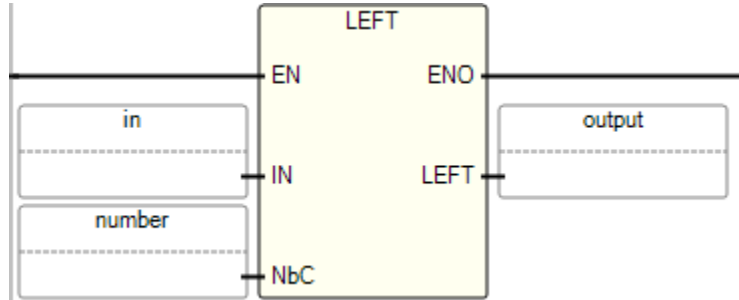

### LEFT Structured Text example

```
LEFT(
STRING LEFT (STRING IN, DINT NbC)
Extract left of a string
```

```
1 number := 3;
2 output := LEFT(in, number);
```

(\* ST Equivalence: \*)

complete\_string := RIGHT ('12345678', 4), LEFT ('12345678', 4), 5;

(\* complete\_string is '56781234'

the value issued from RIGHT call is '5678'

the value issued from LEFT call is '1234'\*)

## Results

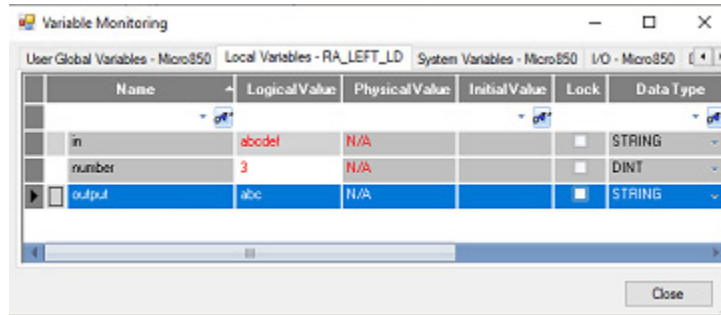

### MID (extract middle of a string)

Extract characters from the middle of a string. Use the position and number of characters provided to calculate the required parts of strings.

Languages supported: Function Block Diagram, Ladder Diagram, Structured Text.

This instruction applies to the Micro810, Micro820, Micro830, Micro850, Micro870 controllers and Micro800 Simulator.



Use this table to help determine the parameter values for this instruction.

Parameter	Parameter Type	Data Type	Description
EN	Input	BOOL	Instruction enable. TRUE - generate portion of a string. FALSE - no generate operation. Applies to Ladder Diagram programs.
IN	Input	STRING	Any non-empty string.
NbC	Input	DINT	Number of characters to be extracted cannot be greater than the length of the IN string.
Pos	Input	DINT	Position of the sub-string. The sub-string first character will be the one pointed to by Pos (first valid position is 1).
MID	Output	STRING	Middle part of the string (its length = NbC). When the number of characters to extract exceeds the length of the IN string, NbC is automatically recalculated to get the remainder of the string only. When NbC or Pos are zero or negative numbers, an empty string is returned.
ENO	Output	BOOL	Enable output. Applies to Ladder Diagram programs.

### MID Function Block Diagram example



### MID Ladder Diagram example

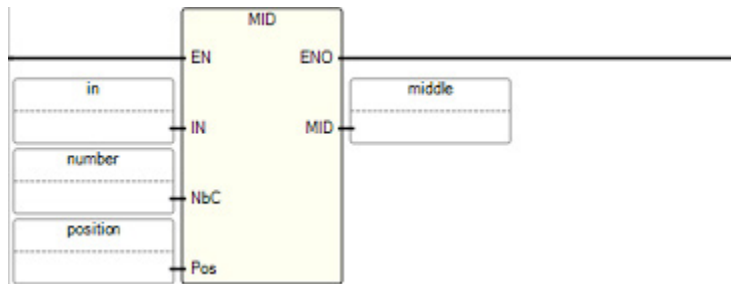

### MID Structured Text example

```
MID {
  STRING MID (STRING IN, DINT NbC, DINT Pos)
  Extract middle of a string
```

```
1 number := 3;
2 position := 2;
3 middle := MID (in, number, position);
```

(\* ST Equivalence: \*)

sub\_string := MID ('abcdefgh', 2, 4);

(\* sub\_string is 'de' \*)

### Results

The Variable Monitoring window displays the following data:

Name	Logical Value	Physical Value	Initial Value	Lock	Data Type
in	abcdel	N/A		<input type="checkbox"/>	STRING
middle	bcd	N/A		<input checked="" type="checkbox"/>	STRING
number	3	N/A		<input type="checkbox"/>	DINT
position	2	N/A		<input type="checkbox"/>	DINT

## MLEN (string length)

Calculates the length of a string.

Languages supported: Function Block Diagram, Ladder Diagram, Structured Text.

This instruction applies to the Micro810, Micro820, Micro830, Micro850, Micro870 controllers and Micro800 Simulator.



Use this table to help determine the parameter values for this instruction.

Parameter	Parameter Type	Data Type	Description
EN	Input	BOOL	Instruction enable. TRUE - calculate length of string. FALSE - no operation. Applies to Ladder Diagram programs.
IN	Input	STRING	Any string.
MLEN	Output	DINT	Number of characters in the IN string.
ENO	Output	BOOL	Enable output. Applies to Ladder Diagram programs.

### MLEN Function Block Diagram example



### MLEN Ladder Diagram example

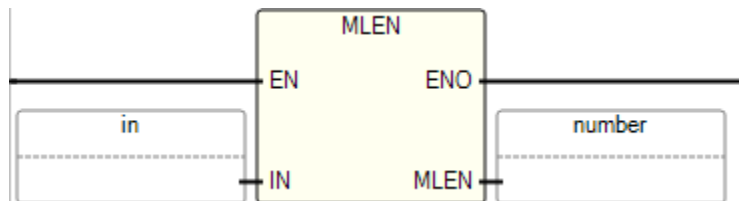

### MLEN Structured Text example

```
MLEN (
  DINT MLEN(STRING IN)
  Get string length

1: number := MLEN(in);
```

```
(* ST Equivalence: *)
nbchar := MLEN (complete_string);
If (nbchar < 3) Then Return; End_if;
prefix := LEFT (complete_string, 3);
(* this program extracts the 3 characters on the left of the string and puts the
result in the prefix string variable. Nothing is done if the string length is less
than 3 characters *)
```

**Results**

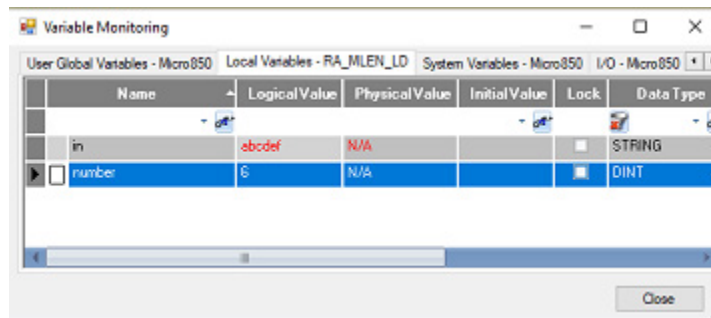

**RIGHT (extract right of a string)**

Extract characters from the right side of a string.  
 Languages supported: Function Block Diagram, Ladder Diagram, Structured Text.  
 This instruction applies to the Micro810, Micro820, Micro830, Micro850, Micro870 controllers and Micro800 Simulator.



Use this table to help determine the parameter values for this instruction.

Parameter	Parameter Type	Data Type	Description
EN	Input	BOOL	Instruction enable. TRUE - extract specified number of characters from the right end of the string. FALSE - no operation. Applies to Ladder Diagram programs.
IN	Input	STRING	Any non-empty string.
NbC	Input	DINT	Number of characters to be extracted. This number cannot be greater than the length of the IN string.
RIGHT	Output	STRING	Right part of the string (length = NbC). Can be: <ul style="list-style-type: none"> <li>empty string if NbC &lt;= 0</li> <li>complete string if NbC &gt;= string length</li> </ul>

Parameter	Parameter Type	Data Type	Description
ENO	Output	BOOL	Enable output. Applies to Ladder Diagram programs.

### RIGHT Function Block Diagram example

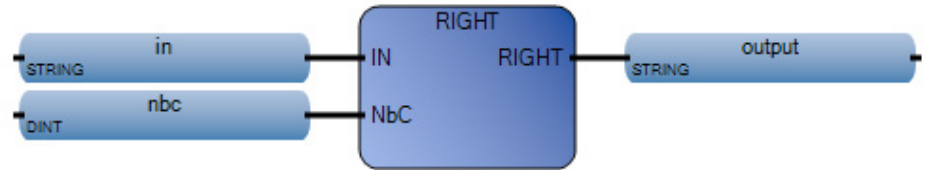

### RIGHT Ladder Diagram example

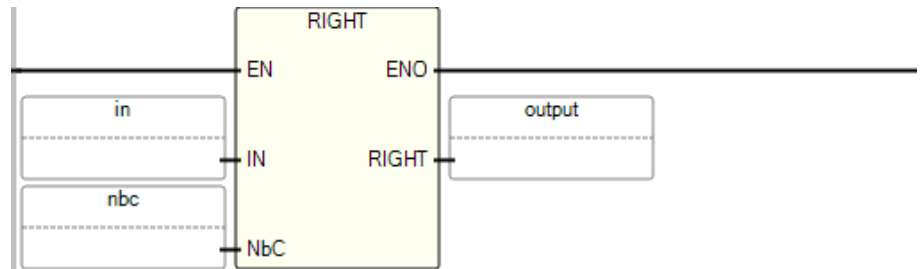

### RIGHT Structured Text example

```
RIGHT (
  STRING RIGHT (STRING IN, DINT NbC)
  Extract right of a string
```

```
1 nbc := 2;
2 output := RIGHT (in, nbc);
```

(\* ST Equivalence: \*)

complete\_string := RIGHT ('12345678', 4), LEFT ('12345678', 4),5;

(\* complete\_string is '56781234'

the value issued from RIGHT call is '5678'

the value issued from LEFT call is '1234'

\*)



### Results

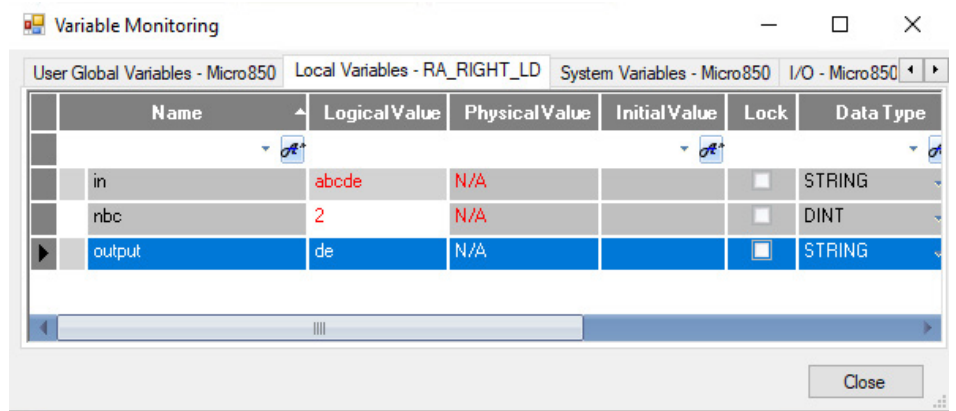

## REPLACE (replace sub-string)

Replaces parts of a string with new sets of characters.

Languages supported: Function Block Diagram, Ladder Diagram, Structured Text.

This instruction applies to the Micro810, Micro820, Micro830, Micro850, Micro870 controllers and Micro800 Simulator.



Use this table to help determine the parameter values for this instruction.

Parameter	Parameter Type	Data Type	Description
EN	Input	BOOL	Function enable. TRUE - replace parts of strings with new characters. FALSE - no operation. Applies to Ladder Diagram programs.
IN	Input	STRING	Any string.
Str	Input	STRING	String to be inserted (to replace NbC chars).
NbC	Input	DINT	Number of characters to be deleted.
Pos	Input	DINT	Position of the first modified character (first valid position is 1).
REPLACE	Output	STRING	Modified string. The NbC characters are deleted at position Pos, then the substring Str is inserted at this position. Can be: <ul style="list-style-type: none"> <li>empty string if Pos &lt;= 0</li> <li>strings concatenation (IN+Str) if Pos is greater than the length of the IN string</li> <li>initial string IN if NbC &lt;= 0</li> </ul>
ENO	Output	BOOL	Enable output. Applies to Ladder Diagram programs.

### REPLACE Function Block Diagram example

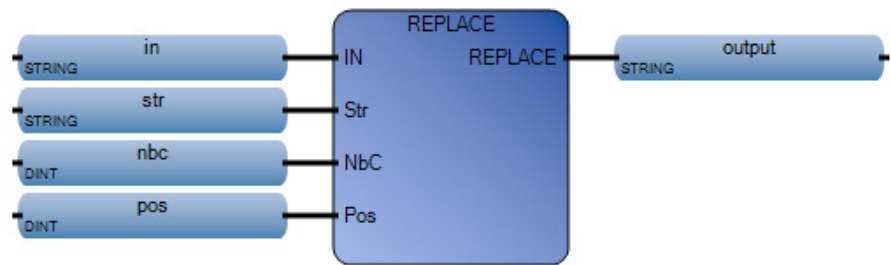

### REPLACE Ladder Diagram example

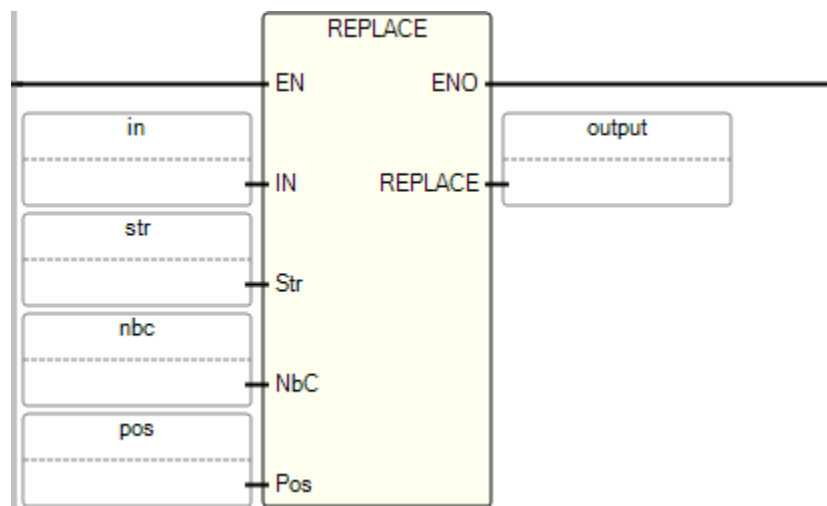

### REPLACE Structured Text example

```
REPLACE (
STRING REPLACE (STRING IN, STRING Str, DINT NbC, DINT Pos)
Replace sub-string
```

```
1 nbc := 4;
2 pos := 2;
3 output := REPLACE (in, str, nbc, pos);
```

Replacing a part of a string with a new set of characters.

(\* ST Equivalence: \*)

MyName := REPLACE ('Mr X JONES', 'Frank', 1, 4);

(\* MyName is 'Mr Frank JONES' \*)

## Results

The screenshot shows a 'Variable Monitoring' window with a table of variables. The window title is 'Variable Monitoring' and it has standard window controls. The table has columns for Name, Logical Value, Physical Value, Initial Value, Lock, and Data Type. The 'output' row is highlighted in blue.

Name	Logical Value	Physical Value	Initial Value	Lock	Data Type
in	abcdef	N/A		<input type="checkbox"/>	STRING
nbc	4	N/A		<input type="checkbox"/>	DINT
output	aghif	N/A		<input type="checkbox"/>	STRING
pos	2	N/A		<input type="checkbox"/>	DINT
str	ghi	N/A		<input type="checkbox"/>	STRING

Close



## Timer instructions

Use Timer instructions to control operations based on time.

Instruction	Description
<a href="#">TOF on page 637</a>	Off-delay timing. Increase an internal timer up to a given value.
<a href="#">TON on page 639</a>	On-delay timing. Increase an internal timer up to a given value.
<a href="#">TONOFF on page 641</a>	Delay turning on an output on a true rung and then delay turning off the output on the false rung.
<a href="#">TP on page 644</a>	Pulse timing. On a rising edge, increases an internal timer up to a given value.
<a href="#">RTO on page 646</a>	Retentive timing. Increases an internal timer when input is active but does not reset the internal timer when input changes to inactive.
<a href="#">DOY on page 648</a>	Turn on an output if the value of the real-time clock is in the range of the Year Time setting.
<a href="#">TDF on page 650</a>	Computes the time difference between TimeA and TimeB.
<a href="#">TOW on page 652</a>	Turns on an output if the value of the real-time clock is in the range of the Time of Week setting.

### Timer instruction configuration

Time accuracy refers to the time between the moment the processor enables a timer instruction and the moment the processor completes the timed interval.

The processor uses the following information from the [timer instruction on page 637](#):

- **Timer** - The timer control address in the timer area of data storage.
- **Time Base** - Determines how the timer operates.
- **Preset** - Specifies the value that the timer must reach before the processor sets the done bit.
- **Accumulated value** - The number of time increments the instruction has counted. When enabled, the timer updates this value continually.

### TOF (timer, off-delay)

Increases an internal timer up to a given value.

Operation details:

- If the EN parameter is used with this instruction block, the timer starts incrementing when EN is set to TRUE, and continues to increment even if EN is set to FALSE.

Languages supported: Function Block Diagram, Ladder Diagram, Structured Text.

This instruction applies to the Micro810, Micro820, Micro830, Micro850, Micro870 controllers and Micro800 Simulator.

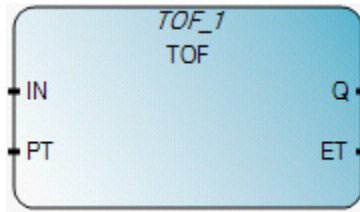

Use this table to help determine the parameter values for this instruction.

Parameter	Parameter type	Data type	Description
IN	Input	BOOL	Input control. TRUE - Falling edge detected, starts increasing internal timer. FALSE - Rising edge detected, stops, and resets internal timer.
PT	Input	TIME	Maximum programmed time. See Time data type.
Q	Output	BOOL	TRUE - total time is <b>not</b> elapsed. FALSE - total time has elapsed.
ET	Output	TIME	Current elapsed time. Possible values range from 0ms to 1193h2m47s294ms.

### TOF timing diagram

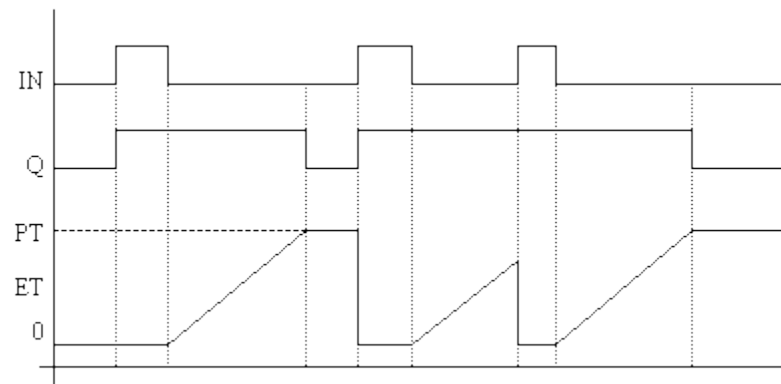

### TOF Function Block Diagram example

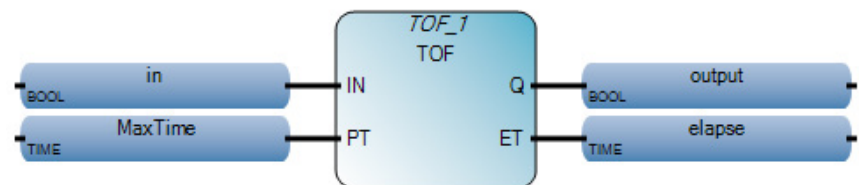

## TOF Ladder Diagram example

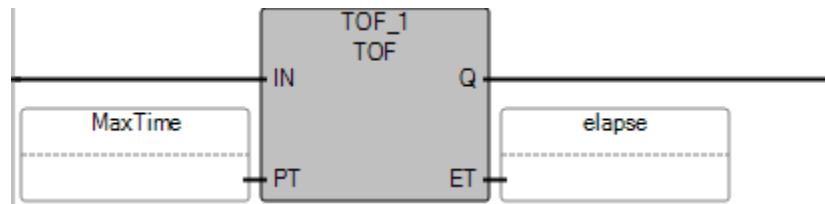

## TOF Structured Text example

```

TOF_1(
void TOF_1(BOOL IN, TIME PT)
Type : TOF, Off-delay timing

1 MaxTime := T#3s;
2 TOF_1(in, MaxTime);
3 output := TOF_1.Q;
4 elapse := TOF_1.ET;

```

## Results

The Variable Monitoring window displays the following data:

Name	Logical Value	Physical Value	Lock	Data Type
in	<input type="checkbox"/>	N/A	<input type="checkbox"/>	BOOL
MaxTime	T#3s	N/A	<input type="checkbox"/>	TIME
output	<input checked="" type="checkbox"/>	N/A	<input type="checkbox"/>	BOOL
elapse	T#2s18ms	N/A	<input type="checkbox"/>	TIME
TOF_1	...	...	<input type="checkbox"/>	TOF

## TON (timer, on-delay)

Increases an internal timer up to a given value.

Operation details:

- Do not use a jump to skip over a TON instruction block in a Ladder Diagram (LD). If a jump is used, the TON timer continues after the elapsed time.
- For example: Rung 1 contains a jump; rung 2 contains a TON instruction block with an elapsed time of 10 seconds; enable the jump from rung 1 to rung 3; disable the jump after 30 seconds; the elapsed time is 30 seconds - not 10 seconds as defined in the elapsed time.

- If the EN parameter is used with TON, the timer starts incrementing when EN is set to TRUE, and continues to increment even if EN is set to FALSE.

Languages supported: Function Block Diagram, Ladder Diagram, Structured Text.

This instruction applies to the Micro810, Micro820, Micro830, Micro850, Micro870 controllers and Micro800 Simulator.



Use this table to help determine the parameter values for this instruction.

Parameter	Parameter type	Data type	Description
IN	Input	BOOL	Input control. TRUE - If rising edge, starts increasing internal timer. FALSE- If falling edge, stops and resets internal timer.
PT	Input	TIME	Maximum programmed time defined using Time data type.
Q	Output	BOOL	TRUE - programmed time has elapsed. FALSE - programmed time has not elapsed.
ET	Output	TIME	Current elapsed time. Possible values range from 0ms to 1193h2m47s294ms.

### TON timing diagram

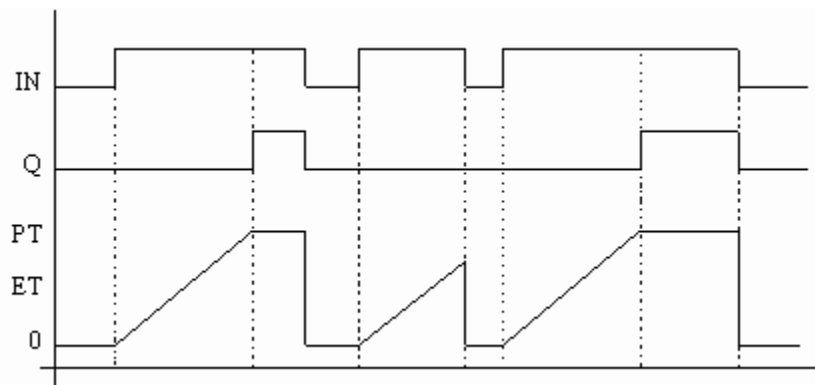



### TON Function Block Diagram example

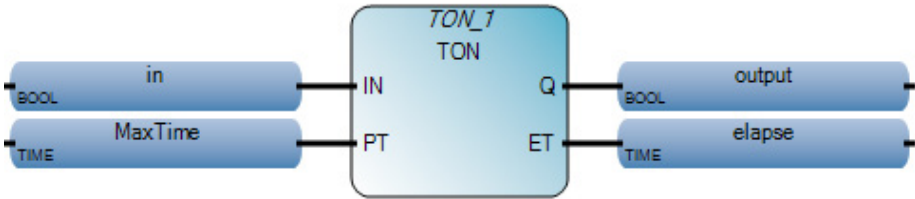

### TON Ladder Diagram example

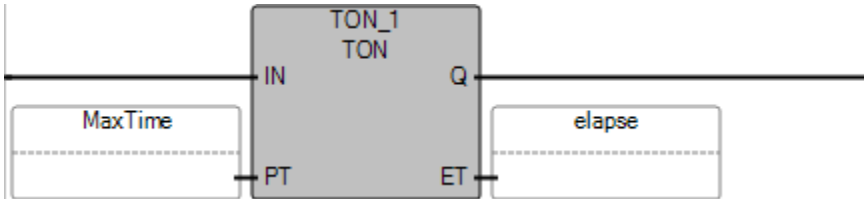

### TON Structured Text example

```

TON_1 (
void TON_1(BOOL IN, TIME PT)
Type : TON, On-delay timing

1 MaxTime := T#3s;
2 TON_1(in, MaxTime);
3 output := TON_1.Q;
4 elapsed := TON_1.ET;

```

### Results

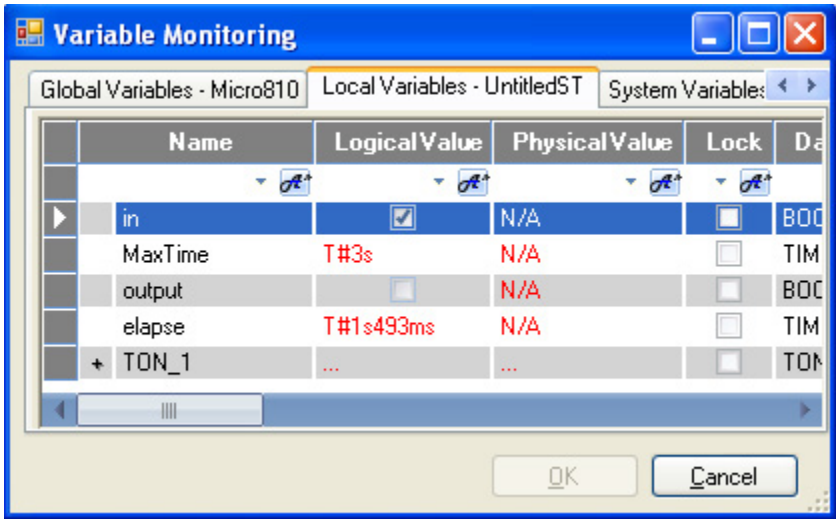

### TONOFF (time-delay, on, off)

Delays turning on an output on a true rung, then delays turning off the output on the false rung.

Operation details:

- If the EN parameter is used with TONOFF, the timer starts incrementing when EN is set to TRUE, and continues to increment even if EN is set to FALSE.

Languages supported: Function Block Diagram, Ladder Diagram, Structured Text.

This instruction applies to the Micro810, Micro820, Micro830, Micro850, Micro870 controllers and Micro800 Simulator.



Use this table to help determine the parameter values for this instruction.

Parameter	Parameter type	Data type	Description
IN	Input	BOOL	Input control. TRUE - Rising Edge detected (IN turns from 0 to 1): <ul style="list-style-type: none"> <li>• start the On-delay timer (PT).</li> <li>• if Programmed Off--delay time (PTOF) is not elapsed, restart the On-delay (PT) timer.</li> </ul> FALSE - Falling Edge detected (IN turns from 1 to 0): <ul style="list-style-type: none"> <li>• if Programmed On-delay time (PT) is not elapsed, stop PT timer and reset ET.</li> <li>• if Programmed On-delay time (PT) is elapsed, the start the Off-delay timer (PTOF).</li> </ul>
PT	Input	TIME	The on-delay time setting defined using the Time data type.
PTOF	Input	TIME	The off-delay time setting defined using the Time data type.
Q	Output	BOOL	TRUE - the Programmed On-delay time is elapsed and Programmed Off-delay time is not elapsed.
ET	Output	TIME	Current elapsed time. Possible values range from 0ms to 1193h2m47s294ms. If the Programmed On-delay time is elapsed and the Off-delay timer is not starting, the elapsed time (ET) remains at the on-delay (PT) value. If the Programmed Off-delay time is elapsed and the Off-delay timer is not starting, the elapsed time (ET) remains at the off-delay (PTOF) value until the rising edge occurs again.

### TONOFF Function Block Diagram example

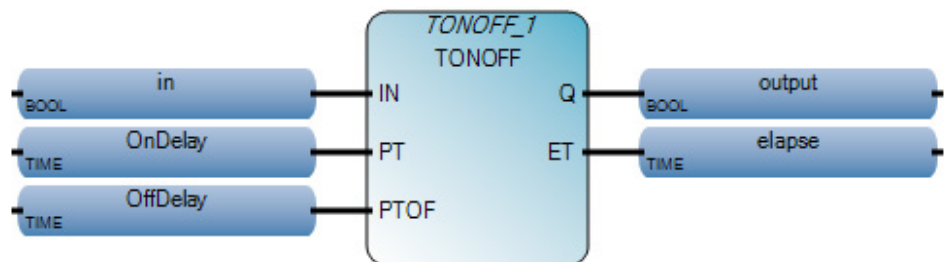

## TONOFF Ladder Diagram example

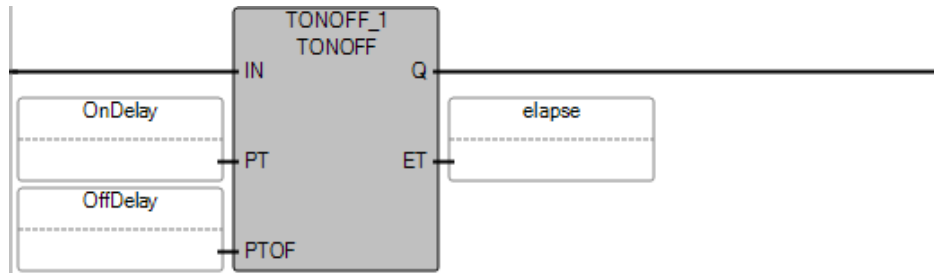

## TONOFF Structured Text example

```
TONOFF_1(
```

```
void TONOFF_1(BOOL IN, TIME PT, TIME PTOF)  
Type : TONOFF, Delay an output-on(true), then delay an output-off(false).
```

```
1 OnDelay := T#3s;  
2 OffDelay := T#5s;  
3 TONOFF_1(in, OnDelay, OffDelay);  
4 output := TONOFF_1.Q;  
5 elapse := TONOFF_1.ET;
```

## Results

The Variable Monitoring window displays the following data:

Name	Logical Value	Physical Value	Lock	Data Type
in	<input checked="" type="checkbox"/>	N/A	<input type="checkbox"/>	BOOL
OnDelay	T#3s	N/A	<input type="checkbox"/>	TIME
OffDelay	T#5s	N/A	<input type="checkbox"/>	TIME
output	<input type="checkbox"/>	N/A	<input type="checkbox"/>	BOOL
elapsed	T#1s60ms	N/A	<input type="checkbox"/>	TIME
TONOFF_1	...	...	<input type="checkbox"/>	TONOFF

The Variable Monitoring window displays the following data:

Name	Logical Value	Physical Value	Lock	Data Type
in	<input type="checkbox"/>	N/A	<input type="checkbox"/>	BOOL
OnDelay	T#3s	N/A	<input type="checkbox"/>	TIME
OffDelay	T#5s	N/A	<input type="checkbox"/>	TIME
output	<input checked="" type="checkbox"/>	N/A	<input type="checkbox"/>	BOOL
elapsed	T#1s446ms	N/A	<input type="checkbox"/>	TIME
TONOFF_1	...	...	<input type="checkbox"/>	TONOFF

## TP (pulse timing)

On a rising edge, increases an internal timer up to a given value. If the timer is elapsed, the internal time is reset.

Operation details:

- If the EN parameter is used with TP, the timer starts incrementing when EN is set to TRUE, and continues to increment even if EN is set to FALSE.

Languages supported: Function Block Diagram, Ladder Diagram, Structured Text.

This instruction applies to the Micro810, Micro820, Micro830, Micro850, Micro870 controllers and Micro800 Simulator.

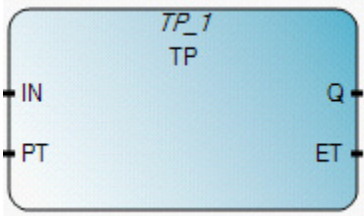

Use this table to help determine the parameter values for this instruction.

Parameter	Parameter type	Data type	Description
IN	Input	BOOL	TRUE - If rising edge, starts increasing internal timer (if not already increasing). FALSE - if timer has elapsed, resets the internal timer. Any change to IN during counting has no effect.
PT	Input	TIME	Maximum programmed time defined using the Time data type.
Q	Output	BOOL	TRUE - timer is counting. FALSE - timer is not counting.
ET	Output	TIME	Current elapsed time. Possible values range from 0ms to 1193h2m47s294ms.

**TP timing diagram**

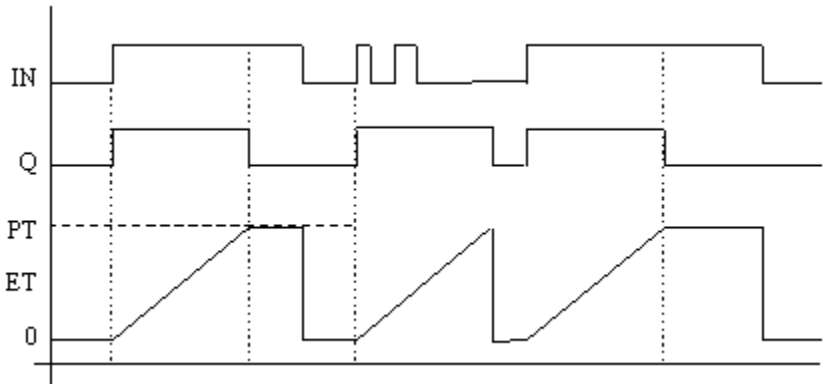

**TP Function Block Diagram example**

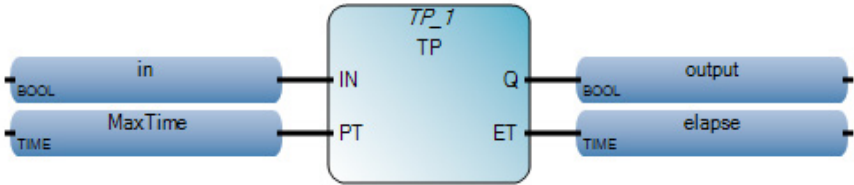

## TP Ladder Diagram example

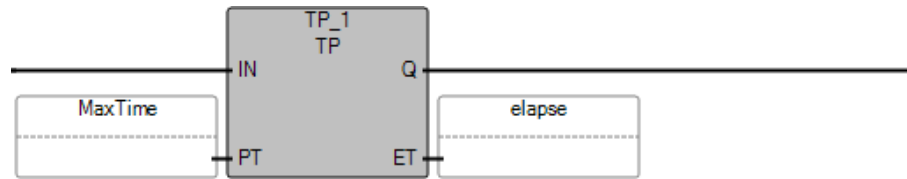

## TP Structured Text example

```
TP_1 {
  void TP_1(BOOL IN, TIME PT)
  Type : TP, Pulse timing
```

```
1 MaxTime := T#3s;
2 TP_1(in, MaxTime);
3 output := TP_1.Q;
4 elapse := TP_1.ET;
```

## Results

Name	Logical Value	Physical Value	Lock	Data
in	<input checked="" type="checkbox"/>	N/A	<input type="checkbox"/>	BOOL
MaxTime	T#3s	N/A	<input type="checkbox"/>	TIME
output	<input checked="" type="checkbox"/>	N/A	<input type="checkbox"/>	BOOL
elapse	T#593ms	N/A	<input type="checkbox"/>	TIME
TP_1	...	...	<input type="checkbox"/>	TP

## RTO (retentive timer, on-delay)

Increases an internal timer when input is active, but does not reset the internal timer when input changes to inactive.

Operation details:

- Micro810 or Micro820 controllers, the RTO internal timer does not persist through a power cycle by default. To persist the internal timer, set the Retained configuration parameter to true.
- Micro830 or Micro850 controller, the RTO internal timer persists through a power cycle.

Languages supported: Function Block Diagram, Ladder Diagram, Structured Text.

This instruction applies to the Micro810, Micro820, Micro830, Micro850, Micro870 controllers and Micro800 Simulator.

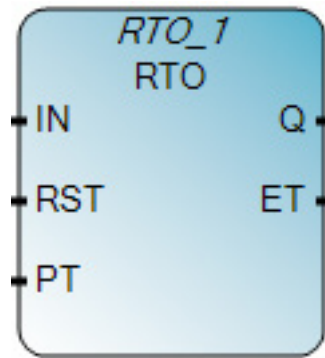

Use this table to help determine the parameter values for this instruction.

Parameter	Parameter type	Data type	Description
IN	Input	BOOL	Input control. TRUE - Rising edge, starts increasing internal timer. FALSE - Falling edge, stops and does not reset the internal timer.
RST	Input	BOOL	TRUE - Rising edge, resets the internal timer. FALSE - Does not reset internal timer.
PT	Input	TIME	Maximum programmed on-delay time. PT is defined using the Time data type.
Q	Output	BOOL	TRUE - Programmed on-delay time is elapsed. FALSE - Program on-delay time has not elapsed.
ET	Output	TIME	Current elapsed time. Values range from 0ms to 1193h2m47s294ms. ET is defined using the Time data type.

### RTO timing diagram example

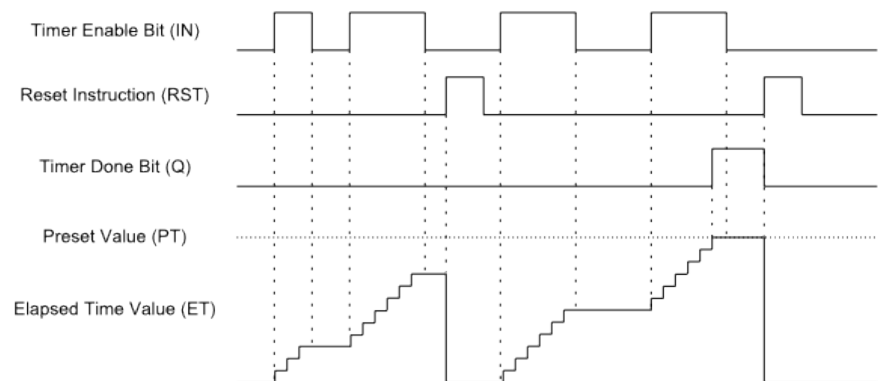

### RTO Function Block Diagram example

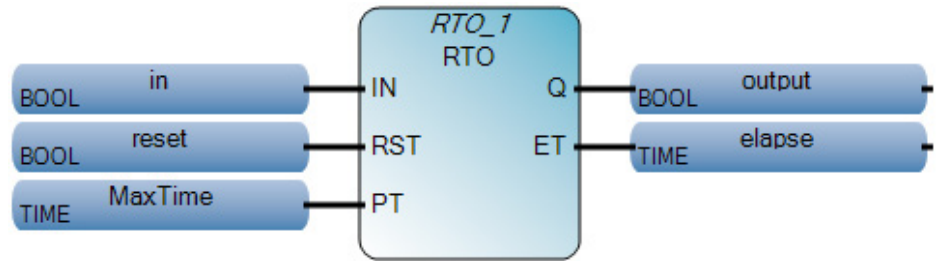

### RTO Ladder Diagram example

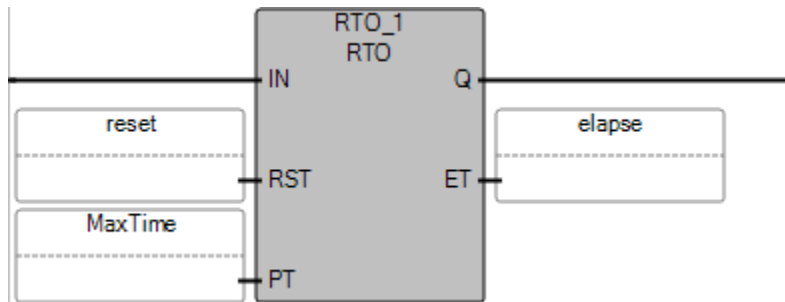

### RTO Structured Text example

```
RTO_1 (
void RTO_1(BOOL IN, BOOL RST, TIME PT)
Type : RTO, Delay an output-on(true). Retain elapsed time until reset.

1 MaxTime := T#3s;
2 RTO_1(in, reset, MaxTime);
3 output := RTO_1.Q;
4 elapse := RTO_1.ET;
```

## DOY (check year for real-time clock)

Turns on an output when the value of real-time clock (RTC) is in the range of the Year Time setting.

Operation details:

- If RTC is not present, the output is always off.
- Configure the Time input parameters with valid ranges as specified in the DOYDATA Data Type. An invalid value faults the controller when TimeX.Enable is set to TRUE and an RTC is present and enabled.

Languages supported: Function Block Diagram, Ladder Diagram, Structured Text.



This instruction applies to the Micro810, Micro820, Micro830, Micro850, Micro870 controllers and Micro800 Simulator.

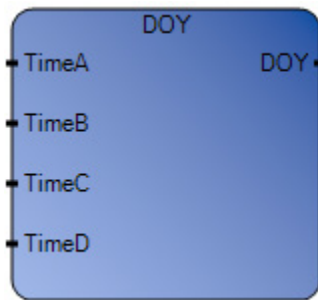

Use this table to help determine the parameter values for this instruction.

Parameter	Parameter Type	Data Type	Description
EN	Input	BOOL	Instruction enable. TRUE - perform the operation. FALSE - do not perform the operation.
TimeA	Input	DOYDATA	Year Time Setting of Channel A. Use the DOYDATA data type to configure TimeA.
TimeB	Input	DOYDATA	Year Time Setting of Channel B. Use the DOYDATA data type to configure TimeB.
TimeC	Input	DOYDATA	Year Time Setting of Channel C. Use the DOYDATA data type to configure TimeC.
TimeD	Input	DOYDATA	Year Time Setting of Channel D. Use the DOYDATA data type to configure TimeD.
DOY	Output	BOOL	If TRUE, the value of the real-time clock is in the range of the Year Time setting of any one of the four channels.

## DOYDATA Data Type

The following table describes the DOYDATA data type.

Parameter	Data Type	Description
Enable	BOOL	TRUE:Enable; FALSE:Disable
YearlyCenturial	BOOL	Type of timer (0:Yearly timer; 1:Centurial timer).
YearOn	UINT	Year On value (must be in set [2000...2098]).
MonthOn	USINT	Month On value (must be in set [1...12]).
DayOn	USINT	Day On value (must be in set [1...31], determined by "MonthOn" value).
YearOff	UINT	Year Off value (must be in set [2000...2098]).
MonthOff	USINT	Month Off value (must be in set [1...12]).
DayOff	USINT	Day Off value (must be in set [1...31], determined by "MonthOff" value).

### DOY Function Block Diagram example

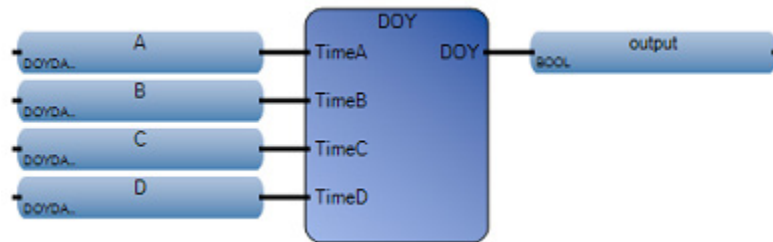

### DOY Ladder Diagram example

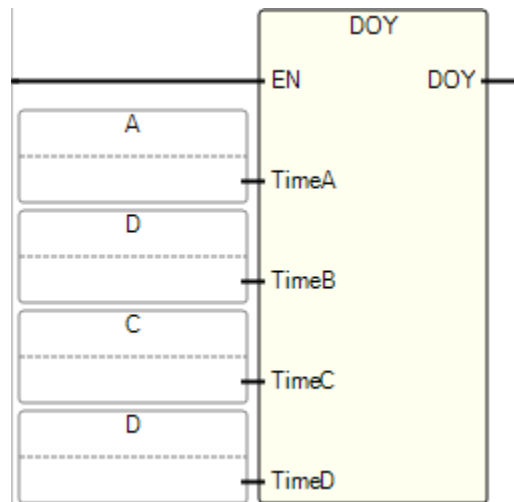

### DOY Structured Text example

```
DOY (
  BOOL DOY(DOYDATA TimeA, DOYDATA TimeB, DOYDATA TimeC, DOYDATA TimeD)
  Turn on output when real-time clock value is within year range.
```

```
1 output := DOY(A, B, C, D);
```

(\* ST Equivalence: \*)

```
TESTOUTPUT := DOY(TIMEA1, TIMEB1, TIMEC1, TIMED1);
```

Compute the time difference between TimeA and TimeB.

Languages supported: Function Block Diagram, Ladder Diagram, Structured Text.

### TDF (time difference)

This instruction applies to the Micro810, Micro820, Micro830, Micro850, Micro870 controllers and Micro800 Simulator.



Use this table to help determine the parameter values for this instruction.

Parameter	Parameter Type	Data Type	Description
EN	Input	BOOL	Instruction enable. TRUE - perform current computation. FALSE - there is no computation. Applies to Ladder Diagram programs.
TimeA	Input	TIME	The start time for time difference computation.
TimeB	Input	TIME	The end time for time difference computation.
ENO	Output	BOOL	Enable output. Applies to Ladder Diagram programs.
TDF	Output	TIME	The time difference for the two time inputs. TDF is name or PIN ID

**TDF Function Block Diagram example**

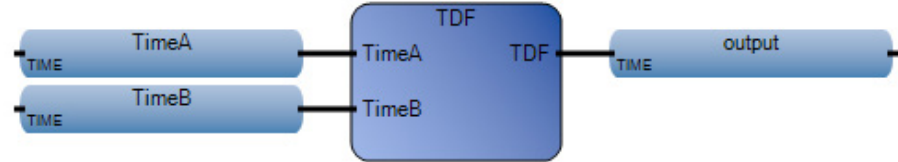

**TDF Ladder Diagram example**

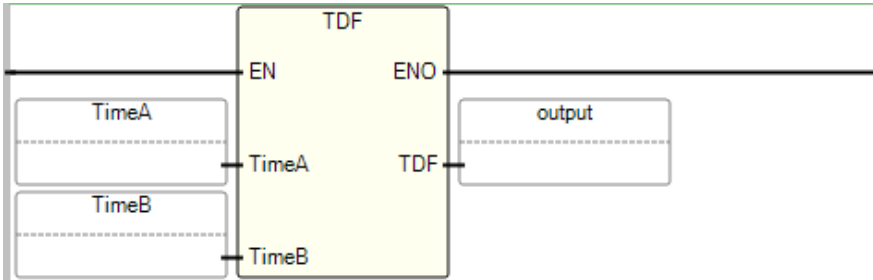

## TDF Structured Text example

```
TDF (
  TIME TDF(TIME TimeA, TIME TimeB)
  Compute time difference.
```

```
1 TimeA := T#10s;
2 TimeB := T#5s;
3 output := TDF(TimeA, TimeB);
```

(\* ST Equivalence: \*)

```
TESTTIMEDIFF := TDF(TESTTIME1, TESTTIME2);
```

## Results

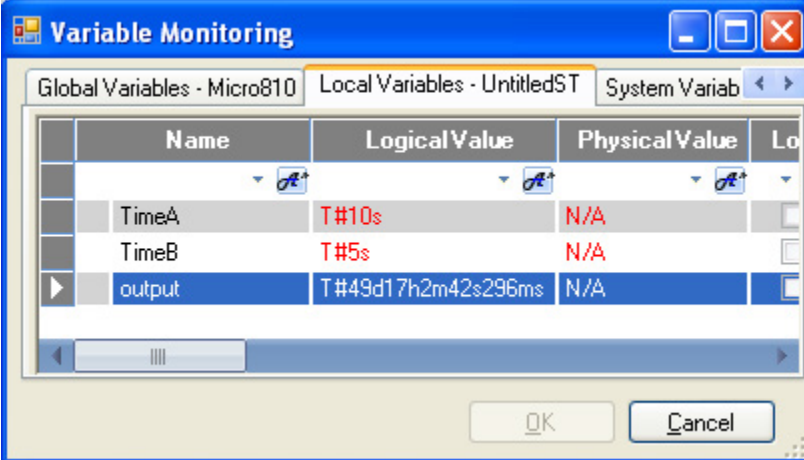

Name	Logical Value	Physical Value	Lo
TimeA	T#10s	N/A	
TimeB	T#5s	N/A	
output	T#49d17h2m42s296ms	N/A	

## TOW (check week for real-time clock)

Turns on an output if the value of the real-time clock (RTC) is in the range of the Time of Week setting.

Operation details:

- If an RTC is not present, the output is always off.
- Configure the Time input parameters with valid ranges as specified in the TOWDATA Data Type. An invalid value faults the controller when TimeX.Enable is set to TRUE and an RTC is present and enabled.

Languages supported: Function Block Diagram, Ladder Diagram, Structured Text.

This instruction applies to the Micro810, Micro820, Micro830, Micro850, Micro870 controllers and Micro800 Simulator.



Use this table to help determine the parameter values for this instruction.

Parameter	Parameter Type	Data Type	Description
EN	Input	BOOL	Instruction enable. When EN = TRUE, perform the operation. When EN = FALSE, do not perform the operation.
TimeA	Input	TOWDATA	Day Time Setting of Channel A. Use the TOWDATA Data Type to define TimeA.
TimeB	Input	TOWDATA	Day Time Setting of Channel B. Use the TOWDATA Data Type to define TimeB.
TimeC	Input	TOWDATA	Day Time Setting of Channel C. Use the TOWDATA Data Type to define TimeC.
TimeD	Input	TOWDATA	Day Time Setting of Channel D. Use the TOWDATA Data Type to define TimeD.
TOW	Output	BOOL	If TRUE, the value of the real-time clock is in the range of the Day Time setting of any one of four channels.

## TOWDATA Data Type

The following table describes the TOWDATA data type:

Parameter	Data Type	Description
Enable	BOOL	TRUE: Enable; FALSE: Disable.
DailyWeekly	BOOL	Type of Timer (0:daily timer; 1:weekly timer).
DayOn	USINT	Day of Week On value (must be in set [0...6]).
HourOn	USINT	Hour On value (must be in set [0...23]).
MinOn	USINT	Minute On value (must be in set [0...59]).
DayOff	USINT	Weekday Off value (must be in set [0...6]).
HourOff	USINT	Hour Off value (must be in set [0...23]).
MinOff	USINT	Minute Off value (must be in set [0...59]).

### TOW Function Block Diagram example

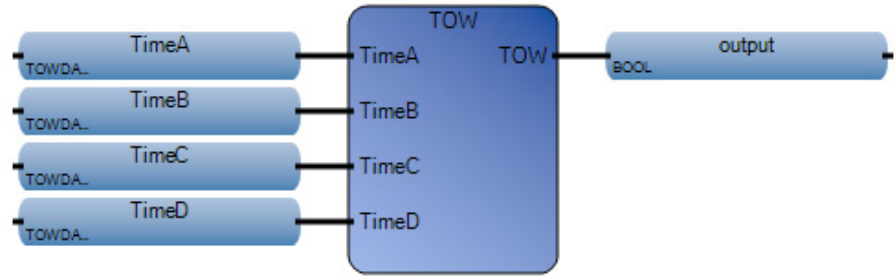

### TOW Ladder Diagram example

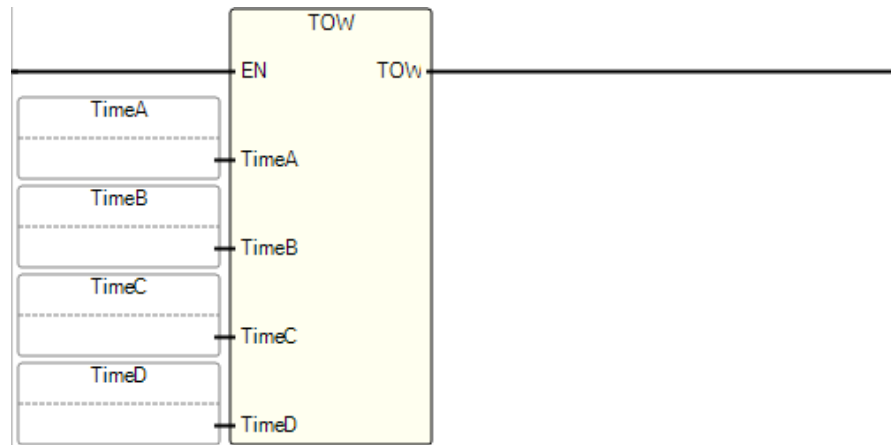

### TOW Structured Text example

```
TOW {
  BOOL TOW(TOWDATA TimeA, TOWDATA TimeB, TOWDATA TimeC, TOWDATA TimeD)
  Turn on output when real-time clock value is within week range.
```

```
1 | output := TOW(TimeA, TimeB, TimeC, TimeD);
```

(\* ST Equivalence: \*)

```
TESTOUTPUT := TOW(TIMEA, TIMEB, TIMEC, TIMED);
```

## Results

	Name	Logical Value	Physical Value	Lock	Data Type
-	TimeA	...	...	<input type="checkbox"/>	TOWDAT, ▾
	TimeA.Enable	<input checked="" type="checkbox"/>	N/A	<input type="checkbox"/>	BOOL
	TimeA.DailyWeekly	<input checked="" type="checkbox"/>	N/A	<input type="checkbox"/>	BOOL
	TimeA.DayOn	1	N/A	<input type="checkbox"/>	USINT
	TimeA.HourOn	10	N/A	<input type="checkbox"/>	USINT
	TimeA.MinOn	20	N/A	<input type="checkbox"/>	USINT
	TimeA.DayOff	2	N/A	<input type="checkbox"/>	USINT
	TimeA.HourOff	15	N/A	<input type="checkbox"/>	USINT
	TimeA.MinOff	30	N/A	<input type="checkbox"/>	USINT
-	TimeB	...	...	<input type="checkbox"/>	TOWDAT, ▾
	TimeB.Enable	<input checked="" type="checkbox"/>	N/A	<input type="checkbox"/>	BOOL
	TimeB.DailyWeekly	<input checked="" type="checkbox"/>	N/A	<input type="checkbox"/>	BOOL
	TimeB.DayOn	2	N/A	<input type="checkbox"/>	USINT
	TimeB.HourOn	15	N/A	<input type="checkbox"/>	USINT
	TimeB.MinOn	20	N/A	<input type="checkbox"/>	USINT
	TimeB.DayOff	3	N/A	<input type="checkbox"/>	USINT
	TimeB.HourOff	10	N/A	<input type="checkbox"/>	USINT
	TimeB.MinOff	30	N/A	<input type="checkbox"/>	USINT
-	TimeC	...	...	<input type="checkbox"/>	TOWDAT, ▾
	TimeC.Enable	<input checked="" type="checkbox"/>	N/A	<input type="checkbox"/>	BOOL
	TimeC.DailyWeekly	<input checked="" type="checkbox"/>	N/A	<input type="checkbox"/>	BOOL
	TimeC.DayOn	3	N/A	<input type="checkbox"/>	USINT
	TimeC.HourOn	20	N/A	<input type="checkbox"/>	USINT
	TimeC.MinOn	10	N/A	<input type="checkbox"/>	USINT
	TimeC.DayOff	4	N/A	<input type="checkbox"/>	USINT
	TimeC.HourOff	25	N/A	<input type="checkbox"/>	USINT
	TimeC.MinOff	55	N/A	<input type="checkbox"/>	USINT
-	TimeD	...	...	<input type="checkbox"/>	TOWDAT, ▾
	TimeD.Enable	<input checked="" type="checkbox"/>	N/A	<input type="checkbox"/>	BOOL
	TimeD.DailyWeekly	<input checked="" type="checkbox"/>	N/A	<input type="checkbox"/>	BOOL
	TimeD.DayOn	5	N/A	<input type="checkbox"/>	USINT
	TimeD.HourOn	10	N/A	<input type="checkbox"/>	USINT
	TimeD.MinOn	15	N/A	<input type="checkbox"/>	USINT
	TimeD.DayOff	6	N/A	<input type="checkbox"/>	USINT
	TimeD.HourOff	35	N/A	<input type="checkbox"/>	USINT
	TimeD.MinOff	40	N/A	<input type="checkbox"/>	USINT
▶	output	<input checked="" type="checkbox"/>	N/A	<input type="checkbox"/>	BOOL ▾





# Index

- operator 97

\*

\* operator 86

/

/ operator 78

+

+ operator 68

<

< operator 245

<= operator 247

<> operator 247

=

= operator 239

>

> operator 242

>= operator 244

1

1Gain operator 85

## A

ABL function block 105

ABS function 63

ACB function block 111

ACL function block 107

ACOS function 65

ACOS\_LREAL function 66

addition operator 68

advanced control blocks

SCALER 508

AFI 525

AHL function block 109

alarms

LIM\_ALRM function block 59

AND operator 150

AND\_MASK function 125

ANY\_TO\_BOOL operator 259

ANY\_TO\_BYTE operator 260

ANY\_TO\_DATE operator 261

ANY\_TO\_DINT operator 263

ANY\_TO\_DWORD operator 264

ANY\_TO\_INT operator 265

ANY\_TO\_LINT operator 266

ANY\_TO\_LREAL operator 267

ANY\_TO\_LWORD operator 268

ANY\_TO\_REAL operator 269

ANY\_TO\_SINT operator 270

ANY\_TO\_STRING operator 270

ANY\_TO\_TIME operator 272

ANY\_TO\_UDINT operator 273

ANY\_TO\_UINT operator 274

ANY\_TO\_ULINT operator 275

ANY\_TO\_USINT operator 276

ANY\_TO\_WORD operator 277

ARD function block 113

arithmetic

ABS function 63

ACOS function 65

ACOS\_LREAL function 66

addition operator 68

ASIN function 69

ASIN\_LREAL function 71

ATAN function 72

ATAN\_LREAL function 74

COS function 75

COS\_LREAL function 77

division operator 78

EXPT function 80

LOG function 82

MOD function 83

MOV operator 85

multiplication operator 86

Neg operator 88

POW function 89

RAND function 91

SIN function 93

SIN\_LREAL 94

SQRT function 96

subtraction operator 97

TAN function 99

TAN\_LREAL function 100

TRUNC function 102

arithmetic operations

1Gain operator 85

ARL function block 115

ASCII function 617

ASIN function 69

ASIN\_LREAL function 71

ATAN function 72

ATAN\_LREAL function 74

AVERAGE function block 279

AWA function block 117

AWT function block 119

**B****binary operations**

AND\_MASK function 125  
 NOT\_MASK function 133  
 OR\_MASK function 134  
 ROL function 136  
 ROR function 137  
 SHL function 139  
 SHR function 141  
 XOR\_MASK function 143

**boolean**

MUX4B function 160  
 MUX8B function 156  
 TTABLE function 153

**boolean operations**

AND operator 150  
 F\_TRIG function block 145  
 NOT operator 151  
 OR operator 149  
 R\_TRIG function block 147  
 RS function block 148  
 SR function block 152  
 XOR operator 151

**branches**

for LD 36  
 inserting 36

**C****calling**

function blocks 21

**CHAR function 619****coils**

changing types of 39  
 changing types of in FBD 39  
 direct type 41  
 direct type in FBD 41  
 inserting 39  
 inserting in FBD 39  
 parallel, inserting 39  
 parallel, inserting in FBD 39  
 pulse falling edge (positive) 43  
 pulse rising edge (positive) 43  
 reset 45  
 reset in FBD 45  
 reverse type 42  
 reverse type in FBD 42  
 set 44  
 set in FBD 44  
 usage and available types for FBD 39  
 usage and available types of 39

**COM\_IO\_WDOG 163****communications**

ABL function block 105  
 ACB function blocks 111  
 ACL function block 107

AHL function block 109  
 ARD function block 113  
 ARL function block 115  
 AWA function block 117  
 AWT function block 119  
 MSG\_CIPGENERIC function block 165  
 MSG\_CIPSYMBOLIC function block 173  
 MSG\_MODBUS function block 177  
 MSG\_MODBUS2 function block 183

**comparison operations**

equal operator 239  
 greater than operator 242  
 greater than or equal operator 244  
 less than operator 245  
 less than or equal operator 247  
 not equal operator 247

**contacts**

changing type of 45  
 direct 48  
 direct in FBD 48  
 inserting 45  
 parallel, inserting 45  
 pulse falling edge (positive) 50  
 pulse rising edge (positive) 49  
 pulse rising edge (positive) in FBD 49  
 reverse 48  
 reverse in FBD 48  
 usage and available types in FBD of 45  
 usage and available types of 45

**COP function block 280****COS function 75****COS\_LREAL function 77****counter**

CTD function block 251  
 CTU function block 253  
 CTUD function block 255

**CTD function block 251****CTU function block 253****CTUD function block 255****D****data conversion**

ANY\_TO\_BOOL operator 259  
 ANY\_TO\_BYTE operator 260  
 ANY\_TO\_DATE operator 261  
 ANY\_TO\_DINT operator 263  
 ANY\_TO\_DWORD operator 264  
 ANY\_TO\_INT operator 265  
 ANY\_TO\_LINT operator 266  
 ANY\_TO\_LREAL operator 267  
 ANY\_TO\_LWORD operator 268  
 ANY\_TO\_REAL operator 269  
 ANY\_TO\_SINT operator 270  
 ANY\_TO\_STRING operator 270  
 ANY\_TO\_TIME operator 272  
 ANY\_TO\_UDINT operator 273

- ANY\_TO\_UINT operator 274
- ANY\_TO\_ULINT operator 275
- ANY\_TO\_USINT operator 276
- ANY\_TO\_WORD operator 277
- data manipulation**
  - AVERAGE function block 279
  - COP function block 280
  - MAX function 287
  - MIN function 286
- DERIVATE function block 479**
- direct**
  - coils 41
  - coils in FBD 41
  - contacts 48
  - contacts in FBD 48
- division operator 78**
- DOY function 648**
- E**
- equal operator 239**
- EXPT function 80**
- F**
- F\_TRIG function block 145**
- FBD (Function Block Diagram)**
  - coils, usage and available types of 39
  - contacts, usage and available types of 45
  - direct coils 41
  - direct contacts 48
  - jumps to labels, inserting 51
  - pulse rising edge (positive) contacts 49
  - reset coils 45
  - returns, inserting 50
  - reverse coils 42
  - reverse contacts 48
  - rungs, inserting 33
  - set coils 44
- FFL 481**
- FFU 489**
- FIND function 622**
- function blocks**
  - ABL 105
  - ACB 111
  - ACL 107
  - AHL 109
  - ARD 113
  - ARL 115
  - AVERAGE 279
  - AWA 117
  - AWT 119
  - calling 21
  - COP 280
  - CTD 251
  - CTU 253
  - CTUD 255
  - DERIVATE 479
  - F\_TRIG 145
  - FFL 481
  - FFU 489
  - HSC 292
  - HSC\_SET\_STS 307
  - HYSTER 494
  - IIM 353
  - INTEGRAL 496
  - IOM 354
  - IPIDCONTROLLER 529
  - KEY\_READ 356
  - LIM\_ALARM 59
  - MC\_AbortTrigger 415
  - MC\_Halt 418
  - MC\_Home 421
  - MC\_MoveAbsolute 424
  - MC\_MoveRelative 428
  - MC\_MoveVelocity 432
  - MC\_Power 436
  - MC\_ReadAxisError 447
  - MC\_ReadBoolParameter 451
  - MC\_ReadParameter 454
  - MC\_ReadStatus 456
  - MC\_Reset 461
  - MC\_SetPosition 463
  - MC\_Stop 466
  - MC\_TouchProbe 470
  - MC\_WriteBoolParameter 473
  - MC\_WriteParameter 475
  - MMINFO 361
  - MODULE\_INFO 364
  - MSG\_CIPGENERIC 165
  - MSG\_CIPSYMBOLIC 173
  - MSG\_MODBUS 177
  - MSG\_MODBUS2 183
  - PID 551
  - PLUGIN\_INFO 375
  - PLUGIN\_READ 377
  - PLUGIN\_RESET 379
  - PLUGIN\_WRITE 381
  - R\_TRIG 147
  - RS 148
  - RTC\_READ 385
  - RTC\_SET 387
  - RTO 646
  - SCALER 508
  - SOCKET\_ACCEPT 568
  - SOCKET\_CREATE 571
  - SOCKET\_DELETE 576
  - SOCKET\_DELETEALL 578
  - SOCKET\_INFO 580
  - SOCKET\_OPEN 586
  - SOCKET\_READ 590
  - SOCKET\_WRITE 594
  - SR 152
  - STACKINT 510
  - SUS 525

- SYS\_INFO 389  
 TOF 637  
 TON 639  
 TONOFF 641  
 TP 644  
 TRIMPOT\_READ 392
- functions**
- ABS 63  
 ACOS 65  
 ACOS\_LREAL 66  
 AND\_MASK 125  
 ASCII 617  
 ASIN 69  
 ASIN\_LREAL 71  
 ATAN 72  
 ATAN\_LREAL 74  
 CHAR 619  
 COS 75  
 COS\_LREAL 77  
 DELETE 620  
 DOY 648  
 EXPT 80  
 FIND 622  
 INSERT 624  
 LCD 341  
 LEFT 626  
 LIMIT 521  
 LOG 82  
 MAX 287  
 MID 628  
 MIN 286  
 MLEN 630  
 MOD 83  
 MUX4B 160  
 MUX8B 156  
 NOT\_MASK 133  
 OR\_MASK 134  
 POW 89  
 RAND 91  
 REPLACE 633  
 RHC 348  
 RIGHT 631  
 ROL 136  
 ROR 137  
 RPC 350  
 SHL 139  
 SHR 141  
 SIN 93  
 SIN\_LREAL 94  
 SQRT 96  
 STIS 395  
 TAN 99  
 TAN\_LREAL 100  
 TDF 650  
 TND 520  
 TOW 652  
 TRUNC 102  
 TTABLE 153
- UIC 397  
 UID 398  
 UIE 400  
 UIF 402  
 XOR\_MASK 143
- functions blocks**
- naming and parameters for 21
- G**
- greater than operator 242**  
**greater than or equal operator 244**
- H**
- HSC function block 292**  
**HSC\_SET\_STS function block 307**  
**HYSTER function block 494**
- I**
- IIM function block 353**
- input/output**
- HSC function block 292  
 HSC\_SET\_STS function block 307  
 IIM function block 353  
 IOM function block 354  
 KEY\_READ function block 356  
 LCD function 341  
 MMINFO function block 361  
 PLUGIN\_INFO function block 375  
 PLUGIN\_READ function block 377  
 PLUGIN\_RESET function block 379  
 PLUGIN\_WRITE function block 381  
 RHC function 348  
 RPC function 350  
 RTC\_READ function block 385  
 RTC\_SET function block 387  
 SYS\_INFO function block 389  
 TRIMPOT\_READ function block 392
- INSERT function 624**
- inserting**
- jumps to labels (FBD elements) 51  
 labels Rungs 33  
 returns (FBD elements) 50  
 rungs (FBD elements) 33
- Instruction block description 165, 173, 183, 279, 280**
- Instruction block description for**
- ABL 105  
 ACB 111  
 ACL 107  
 AHL 109  
 ARD 113  
 ARL 115  
 AVERAGE 279  
 AWA 117  
 AWT 119

- COP 280
- CTD 251
- CTU 253
- CTUD 255
- DERIVATE 479
- F\_TRIG 145
- HSC 292
- HSC\_SET\_STS 307
- HYSTER 494
- IIM 353
- INTEGRAL 496
- IOM 354
- IPIDCONTROLLER 529
- KEY\_READ 356
- LIM\_ALARM 59
- MC\_AbortTrigger 415
- MC\_Halt 418
- MC\_Home 421
- MC\_MoveAbsolute 424
- MC\_MoveRelative 428
- MC\_MoveVelocity 432
- MC\_Power 436
- MC\_ReadAxisError 447
- MC\_ReadBoolParameter 451
- MC\_ReadParameter 454
- MC\_ReadStatus 456
- MC\_Reset 461
- MC\_SetPosition 463
- MC\_Stop 466
- MC\_TouchProbe 470
- MC\_WriteBoolParameter 473
- MC\_WriteParameter 475
- MM\_INFO 361
- MSG\_CIPGENERIC 165
- MSG\_CIPSYMBOLIC 173
- MSG\_MODBUS 177
- MSG\_MODBUS2 183
- PLUGIN\_INFO 375
- PLUGIN\_READ 377
- PLUGIN\_RESET 379
- PLUGIN\_WRITE 381
- R\_TRIG 147
- RST 148
- RTC\_READ 385
- RTC\_SET 387
- RTO 646
- SCALER 508
- SRT 152
- STACKINT 510
- SUS 525
- SYS\_INFO 389
- TOF 637
- TON 639
- TONOFF 641
- TP 644
- TRIMPOT\_READ 392
- instructions 29**
- INTEGRAL function block 496**
- interrupt**
  - STIS function 395
  - UIC function 397
  - UID function 398
  - UIE function 400
  - UIF function 402
- IOM function block 354**
- IPIDCONTROLLER function block 529**
- J**
- jumps**
  - for LD diagrams 51
  - Function Block Diagram, inserting 51
  - Ladder Diagrams, inserting 51
  - Rungs, inserting 33
- K**
- KEY\_READ function block 356**
- keyboard shortcuts**
  - LD language 55
- L**
- labels**
  - Rungs, inserting 33
- Ladder Diagram (LD)**
  - instructions 29
  - language 29
- language**
  - Ladder Diagram (LD) 29
- LCD function 341**
- LD (Ladder Diagram)**
  - branches 36
  - coils, usage and available types of 39
  - contacts, usage and available types of 45
  - direct coils 41
  - direct contacts 48
  - jumps 51
  - pulse falling edge (negative) coils 43
  - pulse falling edge (negative) contacts 50
  - pulse rising edge (positive) coils 43
  - pulse rising edge (positive) contacts 49
  - reset coils 45
  - return statements 50
  - reverse coils 42
  - reverse contacts 48
  - rungs, inserting 33
  - set coils 44
- LD language**
  - keyboard shortcuts 55
- LEFT function 626**
- less than operator 245**
- less than or equal operator 247**
- LIM\_ALARM function block 59**

**LIMIT function 521****LOG function 82****M****MAX function 287****MC\_AbortTrigger function block 415****MC\_Halt function block 418****MC\_Home function block 421****MC\_MoveAbsolute function block 424****MC\_MoveRelative function block 428****MC\_MoveVelocity function block 432****MC\_Power function block 436****MC\_Read 444****MC\_ReadActualPosition 440****MC\_ReadAxisError function block 447****MC\_ReadBoolParameter function block  
451****MC\_ReadParameter function block 454****MC\_ReadStatus function block 456****MC\_Reset function block 461****MC\_SetPosition function block 463****MC\_Stop function block 466****MC\_TouchProbe function block 470****MC\_WriteBoolParameter function block  
473****MC\_WriteParameter function block 475****MID function 628****MIN function 286****MLEN function 630****MMINFO function block 361****MOD function 83****MODULE\_INFO 364****motion**

MC\_AbortTrigger function block 415

MC\_Halt function block 418

MC\_Home function block 421

MC\_MoveAbsolute function block 424

MC\_MoveRelative function block 428

MC\_MoveVelocity function block 432

MC\_Power function block 436

MC\_ReadAxisError function block 447

MC\_ReadBoolParameter function block  
451

MC\_ReadParameter function block 454

MC\_ReadStatus function block 456

MC\_Reset function block 461

MC\_SetPosition function block 463

MC\_Stop function block 466

MC\_TouchProbe function block 470

MC\_WriteBoolParameter function block  
473

MC\_WriteParameter function block 475

**Motion control function blocks 405****MOV operator 85****MSG\_CIPGENERIC function block 165****MSG\_CIPSYMBOLIC function block 173****MSG\_MODBUS function block 177****MSG\_MODBUS2 function block 183****multiplication operator 86****MUX4B function 160****MUX8B function 156****N****naming conventions**

function blocks 21

**Neg operator 88****not equal operator 247****NOT operator 151****NOT\_MASK function 133****O****operators**

1Gain 85

addition 68

AND 150

ANY\_TO\_BOOL 259

ANY\_TO\_BYTE 260

ANY\_TO\_DATE 261

ANY\_TO\_DINT 263

ANY\_TO\_DWORD 264

ANY\_TO\_INT 265

ANY\_TO\_LINT 266

ANY\_TO\_LREAL 267

ANY\_TO\_LWORD 268

ANY\_TO\_REAL 269

ANY\_TO\_SINT 270

ANY\_TO\_STRING 270

ANY\_TO\_TIME 272

ANY\_TO\_UDINT 273

ANY\_TO\_UINT 274

ANY\_TO\_ULINT 275

ANY\_TO\_USINT 276

ANY\_TO\_WORD 277

division 78

equal 239

greater than 242

greater than or equal 244

less than 245

less than or equal 247

MOV 85

multiplication 86

Neg 88

NOT 151

not equal 247

OR 149

subtraction 97

XOR 151

**OR operator 149****OR\_MASK function 134****P****parallel branches for LD diagrams 36**

**parameters**

for function blocks 21

**PID 551****PLUGIN\_INFO function block 375****PLUGIN\_READ function block 377****PLUGIN\_RESET function block 379****PLUGIN\_WRITE function block 381****POW function 89****process control**

DERIVATE function block 479

HYSTER function block 494

INTEGRAL function block 496

IPIDCONTROLLER function block 529

LFL(LIFO load) 501

LFU(LIFO unload) 503

LIMIT function 521

STACKINT function block 510

**program control**

SUS function block 525

TND function 520

**pulse falling edge (negative)**

coils 43

contacts 50

**pulse rising edge (positive)**

coils 43

contacts 49

contacts in FBD 49

**R****R\_TRIG function block 147****RAND function 91****REPLACE function 633****reset**

coils 45

**reset coil in FBD 45****return statements**

for LD diagrams 50

inserting 50

**return symbols**

inserting, FBD elements 50

**reverse**

coils 42

coils in FBD 42

contacts 48

contacts in FBD 48

**RHC function 348****RIGHT function 631****ROL function 136****ROR function 137****RPC function 350****RS function block 148****RTC\_READ function block 385****RTC\_SET function block 387****RTO function block 646****rungs**

Function Block Diagram, inserting 33

inserting 33

labels, inserting 33

**S****SCALER function block 508****SHL function 139****SHR function 141****SIN function 93****SIN\_LREAL 94****SOCKET\_ACCEPT 568****SOCKET\_CREATE 571****SOCKET\_DELETE 576****SOCKET\_DELETEALL 578****SOCKET\_INFO 580****SOCKET\_OPEN 586****SOCKET\_READ 590****SOCKET\_WRITE 594****SQRT function 96****SR function block 152****STACKINT function block 510****stencil**

coils types available for FBD 39

coils types available for LD diagrams

39

contact elements available for LD

diagrams 45

rungs, inserting in LD containers 33

**STIS function 395****string manipulation**

ASCII function 617

CHAR function 619

DELETE function 620

FIND function 622

INSERT function 624

LEFT function 626

MID function 628

MLEN function 630

REPLACE function 633

RIGHT function 631

**subtraction operator 97****SUS function block 525****SYS\_INFO function block 389****T****TAN function 99****TAN\_LREAL function 100****TDF function 650****time**

DOY function 648

RTO function block 646

TDF function 650

TOF function block 637

TON function block 639

TONOFF function block 641

TOW function 652

TP function block 644

TND function 520  
TOF function block 637  
TON function block 639  
TONOFF function block 641  
TOW function 652  
TP function block 644  
TRIMPOT\_READ function block 392  
TRUNC function 102  
TTABLE function 153

## U

UIC function 397  
UID function 398  
UIE function 400  
UIF function 402

## X

XOR operator 151  
XOR\_MASK function 143



## Rockwell Automation support

Use these resources to access support information.

<b>Technical Support Center</b>	Find help with how-to videos, FAQs, chat, user forums, and product notification updates.	<a href="http://rok.auto/support">rok.auto/support</a>
<b>Knowledgebase</b>	Access Knowledgebase articles.	<a href="http://rok.auto/knowledgebase">rok.auto/knowledgebase</a>
<b>Local Technical Support Phone Numbers</b>	Locate the telephone number for your country.	<a href="http://rok.auto/phonesupport">rok.auto/phonesupport</a>
<b>Literature Library</b>	Find installation instructions, manuals, brochures, and technical data publications.	<a href="http://rok.auto/literature">rok.auto/literature</a>
<b>Product Compatibility and Download Center (PCDC)</b>	Get help determining how products interact, check features and capabilities, and find associated firmware.	<a href="http://rok.auto/pcdc">rok.auto/pcdc</a>

## Documentation feedback

Your comments help us serve your documentation needs better. If you have any suggestions on how to improve our content, complete the form at [rok.auto/docfeedback](http://rok.auto/docfeedback).

## Waste Electrical and Electronic Equipment (WEEE)



At the end of life, this equipment should be collected separately from any unsorted municipal waste.





Rockwell Automation maintains current product environmental information on its website at [rok.auto/pec](http://rok.auto/pec).

Allen-Bradley, expanding human possibility, Logix, Rockwell Automation, and Rockwell Software are trademarks of Rockwell Automation, Inc.

EtherNet/IP is a trademark of ODVA, Inc.

Trademarks not belonging to Rockwell Automation are property of their respective companies.

Rockwell Otomasyon Ticaret A.Ş. Kar Plaza İş Merkezi E Blok Kat:6 34752, İçerenköy, İstanbul, Tel: +90 (216) 5698400 EEE Yönetmeliğine Uygundur

Connect with us.    

**rockwellautomation.com** ————— expanding **human possibility**<sup>™</sup>

AMERICAS: Rockwell Automation, 1201 South Second Street, Milwaukee, WI 53204-2496 USA, Tel: (1) 414.382.2000, Fax: (1) 414.382.4444

EUROPE/MIDDLE EAST/AFRICA: Rockwell Automation NV, Pegasus Park, De Kleetlaan 12a, 1831 Diegem, Belgium, Tel: (32) 2 663 0600, Fax: (32) 2 663 0640

ASIA PACIFIC: Rockwell Automation, Level 14, Core F, Cyberport 3, 100 Cyberport Road, Hong Kong, Tel: (852) 2887 4788, Fax: (852) 2508 1846